



SB®

CUSCINETTI A RULLINI

01.01.2018

NEEDLE BEARINGS

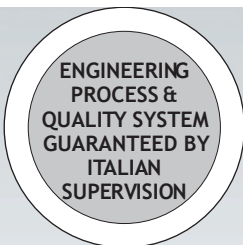

COMPANY WITH
QUALITY SYSTEM
CERTIFIED BY DNV GL
= ISO 9001 =

CUSCINETTI A RULLINI NEEDLE BEARINGS



CATALOGO TECNICO GENERALE
GENERAL TECHNICAL CATALOGUE

01.01.18



ISB®







SEDE PRINCIPALE
HEAD OFFICE



MAGAZZINO
WAREHOUSE

UFFICIO COMMERCIALE
SALES DEPARTMENT

 **ITALCUSCINETTI** S.p.A.
forniture industriali
industrial supplies



ISB Bearing China (Shanghai) Co., Ltd.

ISB Bearing India Pvt. Ltd.

ITALCUSCINETTI S.p.A. a Socio Unico - C.F. e P.I. CEE IT 00966080350
Via Caponnetto, 15 - 42048 Rubiera (Reggio Emilia) ITALIA
ITALIA Tel. +39 0522 621811 - comm.it@italcuscinetti.it
EXPORT Tel. +39 0522 621830 - export@italcuscinetti.it
R.E.A. C.C.I.A.A. RE 153325 - Capitale Sociale € 1.000.000 i.v.
info@italcuscinetti.it - www.italcuscinetti.it

艾斯比轴承上海有限公司 - Building 8 No. 860 Zhongde Road
Dagang Town, Songjiang District - Shanghai 201616 (People's Republic of China)
Tel. 0086 021 5988 5302 - Fax 0086 021 5988 5305 - info@italbearings.cn

Production control - Controllo processo produttivo



www.isb-bearing.com



PROGRAMMA GENERALE DI VENDITA

GENERAL SALES PROGRAM



Cuscinetti e componenti *
*Bearings and components **



ELECTRICAL MOTORS STANDARD

**Cuscinetti per applicazioni
"bassa rumorosità" ***
*Bearings for "low noise" applications **



Cuscinetti di super precisione *
*Super precision bearings **



Cuscinetti a rullini *
*Needle bearings **



Cuscinetti di base *
*Slewing bearings **



Supporti autoallineanti *
*Self-aligning bearing units **



**Snodi sferici
teste a snodo - forcelle ***
*Spherical plain bearings
rod ends - clevises **



Boccole *
*Bushes **



**Componenti per la
movimentazione lineare ***
*Components for linear motion **



Ruote libere *
*Free wheels **



**Cuscinetti e supporti
autoallineanti ***
*Bearings and Self-aligning
bearing units **

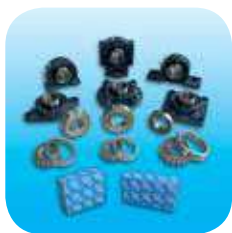

Disponibile grande e completo assortimento di cuscinetti con pronta consegna.

Big and full assortment of bearings with prompt delivery.

Cuscinetti SKF - FAG
SKF - FAG Bearings





CATALOGO TECNICO GENERALE
GENERAL TECHNICAL CATALOGUE

Distributore / Distributor



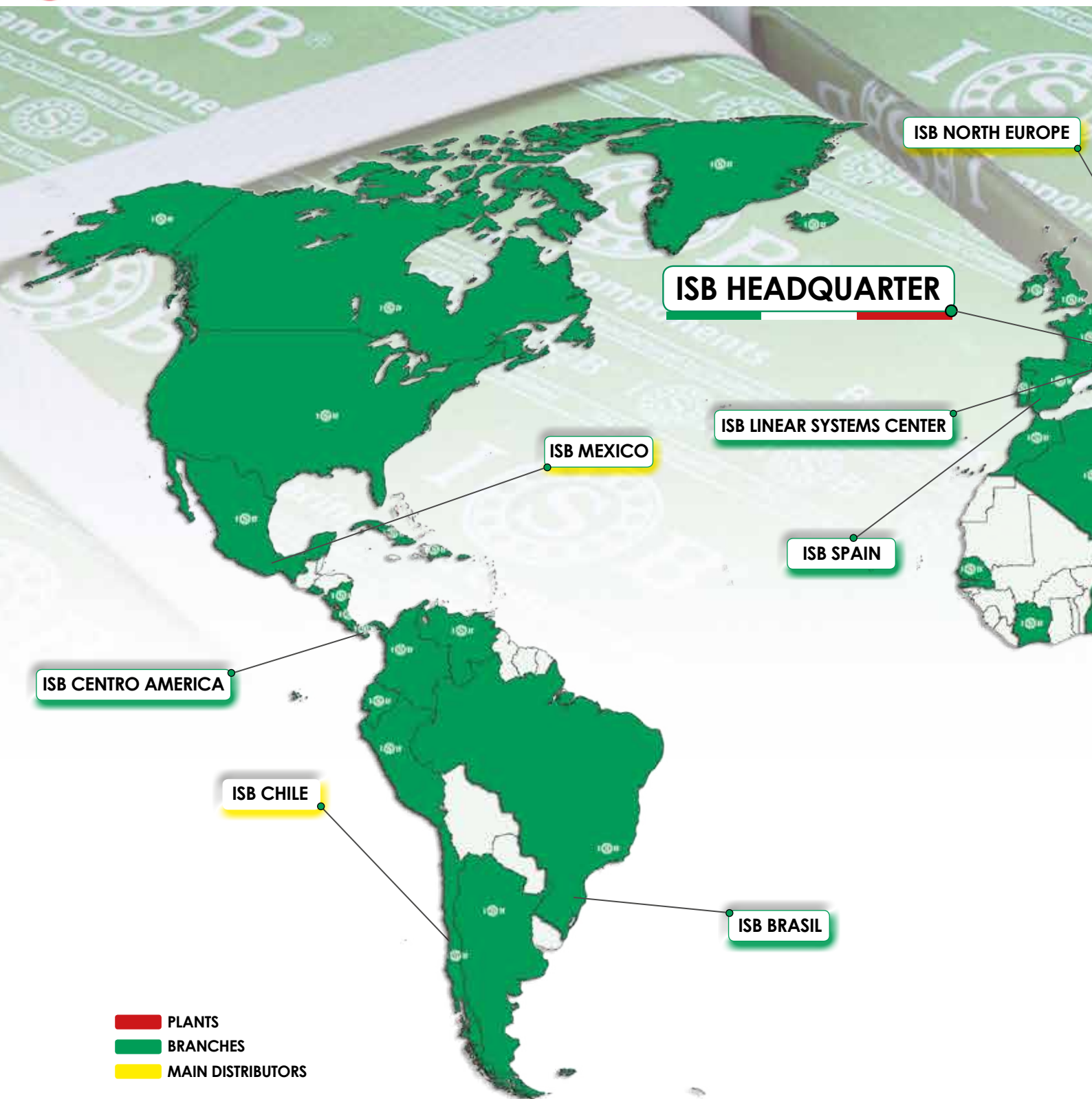

- | | | | |
|----------------|----------------|-------------------------|---------------|
| 1 ALGERIA | 12 BULGARIA | 23 DENMARK | 34 GREECE |
| 2 ANGOLA | 13 CANADA | 24 ECUADOR | 35 INDIA |
| 3 SAUDI ARABIA | 14 CHILE | 25 EGYPT | 36 IRELAND |
| 4 ARGENTINA | 15 CHINA | 26 EL SALVADOR | 37 ICELAND |
| 5 ARMENIA | 16 CYPRUS | 27 UNITED ARAB EMIRATES | 38 ISRAEL |
| 6 AUSTRALIA | 17 COLOMBIA | 28 ESTONIA | 39 ITALY |
| 7 AUSTRIA | 18 SOUTH KOREA | 29 FINLAND | 40 KAZAKHSTAN |
| 8 AZERBAIJAN | 19 IVORY COAST | 30 FRANCE | 41 KENYA |
| 9 BELARUS | 20 COSTA RICA | 31 GERMANY | 42 LATVIA |
| 10 BELGIUM | 21 CROATIA | 32 JAPAN | 43 LEBANON |
| 11 BRAZIL | 22 CUBA | 33 JORDAN | 44 LITHUANIA |



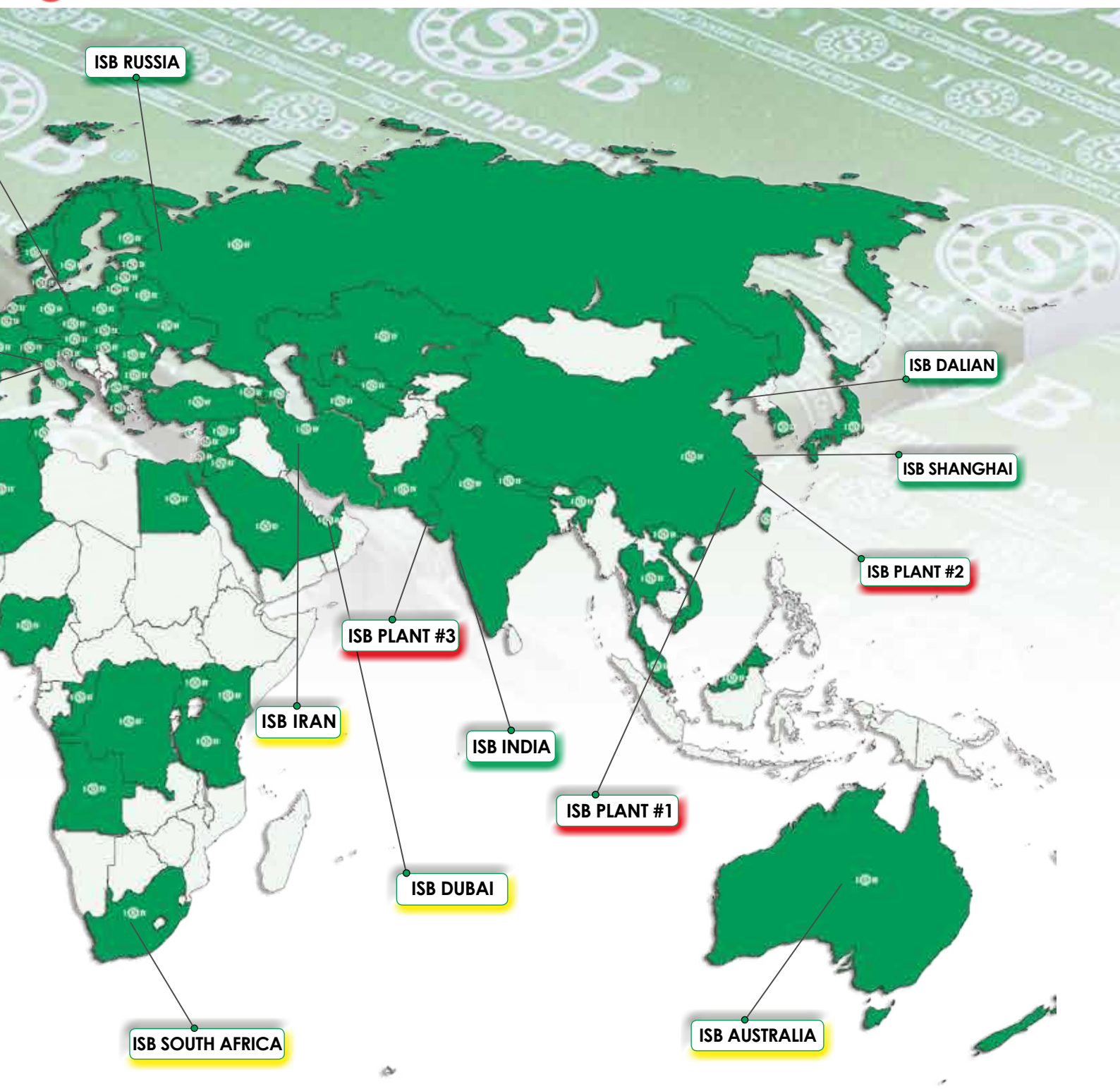

Our presence in the world



-  45 MACEDONIA
-  46 MALAYSIA
-  47 MALTA
-  48 MOROCCO
-  49 MEXICO
-  50 NEPAL
-  51 NICARAGUA
-  52 NIGERIA
-  53 NORWAY
-  54 NEW ZEALAND
-  55 NETHERLANDS

-  56 PANAMA
-  57 PAKISTAN
-  58 PERU
-  59 POLAND
-  60 PORTUGAL
-  61 UNITED KINGDOM
-  62 REPUBLIQUE of the CONGO
-  63 DEM. REP. of the CONGO
-  64 CZECH REPUBLIC
-  65 DOMINICAN REPUBLIC
-  66 SLOVAKIAN REPUBLIC

-  67 RUMANIA
-  68 RUSSIA
-  69 SAN MARINO
-  70 SENEGAL
-  71 SYRIA
-  72 SLOVENIA
-  73 SPAIN
-  74 UNITED STATES of AMERICA
-  75 SOUTH AFRICA
-  76 SWEDEN
-  77 SWITZERLAND

-  78 TAIWAN
-  79 TANZANIA
-  80 THAILANDIA
-  81 TUNISIA
-  82 TURKEY
-  83 TURKMENISTAN
-  84 UKRAINE
-  85 REPUBLIC OF UGANDA
-  86 HUNGARY
-  87 UZBEKISTAN
-  88 VIETNAM
-  89 VENEZUELA





PRODUZIONE
PRODUCTION

Tutti i prodotti ISB® sono costruiti esclusivamente da aziende con Sistema Qualità certificato secondo le norme UNI EN ISO 9001:2008.

All ISB® products are manufactured exclusively by companies with UNI EN ISO 9001:2008 certified Quality System.





CONTROLLO QUALITÀ ASIA - ISB BEARING CHINA
ASIA QUALITY CONTROL - ISB BEARING CHINA



... un'ulteriore serie di controlli vengono eseguiti da Laboratori esterni specializzati, attrezzati con moderni strumenti.

Laboratorio Controllo Qualità.

... an additional series of tests are conducted by specialised third party Laboratories using the latest instruments

Quality Control Laboratory.





CONTROLLO QUALITÀ ITALIA
ITALY QUALITY CONTROL

... centro di controllo per la qualità nella nostra sede in ITALIA.

... uno staff di Ingegneri tecnici della Qualità, al vostro servizio.

... a quality control centre is located in our headquarter in ITALY.

... our staff of technical engineers at your service, for Quality.



BEARING TESTING REPORT

№ 6 2011
Pagina 1 di 3

FORNITORE ISB - INA
Cuscinetto a rullini NKS 55

DATA CONTROLLO 04 Febbraio 2011

OTI' CONTROLLATA 1 + 1

ITEM	STANDARD	PRECISIONE PN (standard)		RILEVAZIONI (Testing Value)				
		ISB	INA	Supplier 3	Supplier 4	Supplier 5		
25700700	Slovenia	na	na					
80803107090	Slovenia	na	na					
HARDNESS (HRC)								
INNER RING	61 ± 64	61.5	59.5					
ROLLER / SPHERE		62	na					
OUTER RING	59 ± 63	na	na					
MAX		na	na					
MIN		na	na					
DIMENSIONS PRECISION (mm)								
60s		na	na					
Vdp		na	na					
Vdmp		71.998	71.996					
MAX	72.000	71.998	71.996					
MIN	71.987	0.006	0.003					
Vdp	0.010	0.007	0.003					
Vdmp	0.010	na	na					
So		na	na					
Ko		na	na					
Ko		na	0.003					
So		0.025	na					
Ko		na	0.006					
Ko		na	na					
So		na	0.035					
So		na	0.055					
RUNNING ACCURACY (mm)								
60s		na	na					
Vdp		na	na					
MAX	22.000	21.943	21.943					
MIN	21.880	21.943	21.943					
Vdp	0.025	0.005	0.003					
Vdmp		70	67					
RADIAL CLEARANCE Gr (°)								
60s		na	na					
Vdp		na	na					
MAX		na	na					
MIN		na	na					
Vdp		na	na					
Vdmp		na	na					
MAX		na	na					
MIN		na	na					
Vdp		na	na					
Vdmp		na	na					
NOISE (dB) (")								
L		na	na					
M		na	na					
H		na	na					
ROUGHNESS Ra (µm)								
outer bore		0.63	0.287					
outer ring		0.15	0.132					
roller / sphere		0.20	0.193					
outer race		na	na					
inner race		na	na					
Contact surface (roller / race)								

BEARING TESTING REPORT

№ 6 2009
Pagina 1 di 3

FORNITORE ISB - INA
Cuscinetto a rullini NKS 55

DATA CONTROLLO 04 Agosto 2009

OTI' CONTROLLATA 1 + 1

ITEM	STANDARD	PRECISIONE PN (standard)		RILEVAZIONI (Testing Value)				
		Supplier 1	Supplier 2	Supplier 3	Supplier 4	Supplier 5		
25700700	Slovenia							
80803107090	Slovenia							

ATTACHED:

BEARING TESTING REPORT

№ 6 2009
Pagina 1 di 3

FORNITORE ISB - INA
Cuscinetto a rullini NKS 55

DATA CONTROLLO 04 Agosto 2009

OTI' CONTROLLATA 1 + 1

ITEM	STANDARD	PRECISIONE PN (standard)		RILEVAZIONI (Testing Value)				
		Supplier 1	Supplier 2	Supplier 3	Supplier 4	Supplier 5		
25700700	Slovenia							
80803107090	Slovenia							

ATTACHED:

AGRICOLTURA
CASA
INDUSTRIA
MACCHINARI
TEMPO LIBERO
UFFICIO
VEICOLI

AGRICULTURE
HOME
INDUSTRY
MACHINERIES
FREE TIME
OFFICE
VEHICLES



Le numerose linee di cuscinetti e componenti ISB® consentono di soddisfare le esigenze nei più svariati settori applicativi. L'ampia gamma e la qualità dei prodotti è tale da garantire applicazioni anche in condizioni d'impiego gravose. I cuscinetti e componenti ISB® vantano una produzione articolata e completa di tutte le tipologie, indicata pertanto a soddisfare le più svariate esigenze applicative.

The diverse product lines of ISB® bearings and components make it possible to satisfy the needs of a wide variety of fields of application. The wide range and quality of products is also a guarantee for heavy duty applications. ISB® bearings and components are available in versions across-the-board and can meet the requirements of a wide variety of demanding applications.



CATALOGO TECNICO GENERALE
GENERAL TECHNICAL CATALOGUE



Capitolo Chapter	Titolo Title	Pagina Page
1	ISB - Marchio sinonimo di qualità / ISB - A brand which means quality	3
2	Programma generale di vendita / General sales program	4
3	Generalità - Generality	5
4	Coefficienti di carico - Load ratings	5
4.1	Coefficiente di carico dinamico C - Basic dynamic load rating C	5
4.2	Coefficiente di carico statico C ₀ - Basic static load rating C ₀	5
5	Calcolo della durata - Calculation of the rating life	5
5.1	Durata teorica richiesta - Rating life requested	6
5.2	Durata d'esercizio - Operating life	6
5.3	Carico statico equivalente P ₀ - Equivalent static load P ₀	6
5.4	Carico dinamico equivalente P - Equivalent dynamic load P	7
5.5	Coefficiente di sicurezza statico S ₀ - Static load safety factor S ₀	7
6	Influenza della temperatura d'esercizio - Influence of operating temperature	8
7	Struttura delle piste di rotolamento - Materials for rolling bearing raceways	8
8	Numero di giri e velocità massima ammissibile - Number of revolutions and maximum speed allowed	9
9	Lubrificazione - Lubrication	9
9.1	Lubrificazione a grasso - Grease lubrication	10
9.2	Lubrificazione ad olio - Oil lubrication	11
9.3	Tipi di lubrificazione ad olio - Kinds of oil lubrication	11
9.3.1	Lubrificazione a goccia d'olio - Drip feed lubrication	11
9.3.2	Lubrificazione a bagno d'olio - Oil bath lubrication	11
9.3.3	Lubrificazione a circolazione d'olio - Recirculating oil lubrication	11
9.3.4	Lubrificazione a nebbia d'olio - Fog oil lubrication	11
9.3.5	Lubrificazione ad olio centralizzata - Centralised oil lubrication	11
10	Tabelle delle tolleranze - Tolerances tables	12
11	Giuoco radiale dei cuscinetti a rullini - Radial clearance of needle roller bearings	17
12	Montaggio e smontaggio - Mounting and dismounting	18
13	Note generali - General notes	18
14	Confezioni ed imballi - Packings	18
15	Simboli ed unità di misura - Tolerance symbols and definitions	19
16	Indice generale dei prodotti - Products general index	20

1

ISB MARCHIO SINONIMO DI QUALITÀ

ISB A BRAND WHICH MEANS QUALITY

ISB, marchio creato grazie alla collaborazione di un gruppo di costruttori, che hanno saputo mettere a frutto l'esperienza di molti anni maturata nel settore della produzione di cuscinetti a rullini, utilizzando un elevato know how tecnico ed apparecchiature di avanzata tecnologia sia per quel che concerne la produzione, che il controllo. Illustriamo la gamma completa dei prodotti, ricordando che in caso di applicazioni speciali, è possibile contattare l'Ufficio Tecnico. Questo catalogo ha il compito di aiutare i progettisti di macchine, cercando di fornire le informazioni necessarie, con il preciso scopo di trovare le migliori soluzioni possibili per l'impiego dei cuscinetti a rullini.

La prima parte del catalogo illustra quelle che sono le caratteristiche tecniche di tutti i cuscinetti a rullini **ISB** (tolleranze dimensionali, giuoco d'esecuzione, tipologia di lubrificazione, ed altre informazioni che possano guidare verso la miglior scelta).

Nella seconda parte del catalogo vengono illustrate le tavole dei vari cuscinetti a rullini **ISB**.

Tutte le caratteristiche tecniche di costruzione sono state standardizzate in accordo alle norme ISO e DIN con il preciso scopo di fornire un prodotto di qualità, intercambiabile e che mantenga le medesime caratteristiche nel tempo.

***ISB**, is a mark especially created thanks to a deep co-operation among a group of producers able to make the best of their years of experience in the field of needle bearings. A very high technical know how and the most advanced machinery for both production and control are used. We will give a complete idea of our range of products, but would like to remind you that in case of special applications our Technical Dept. is at your disposal to help you.*

This catalogue has been created to help machinery's designers: we have included all information that are indispensable to have a correct application of needle bearings.

*The first part of it, is for technical details of all **ISB** needle bearings (dimensional tolerances, radial clearances, kind of lubrication, and other information requested to obtain the best choice).*

*The second part includes tables of all **ISB** bearings: all technical characteristics are in accordance with ISO and DIN international requirements, our aim is to supply all our customers with a quality product able to keep its characteristic unchanged during the years.*



Gabbie a rullini <i>Needle roller and cage assemblies</i>	25
Gabbie a rullini per imbiellaggi <i>Needle roller and cage assemblies for connecting rod bearings arrangements</i>	37
Gabbie lineari piane a rullini <i>Needle roller flat cages</i>	45
Astucci a rullini aperti / Astucci a rullini con fondello <i>Drawn cup needle roller bearings open / Drawn cup needle roller bearings closed</i>	49
Cuscinetti a rullini <i>Needle roller bearings</i>	57
Cuscinetti a rullini senza bordi <i>Needle roller bearings without ribs</i>	71
Cuscinetti orientabili a rullini <i>Aligning needle roller bearings</i>	77
Cuscinetti combinati a rullini <i>Combined needle roller bearings</i>	81
Anelli interni <i>Inner rings</i>	89
Ruote libere ad astuccio <i>Drawn cup roller clutches</i>	95
Cuscinetti assiali a rulli cilindrici <i>Axial cylindrical roller bearings</i>	101
Rotelle a rulli <i>Yoke type track rollers</i>	119
Perni folli <i>Stud type track rollers</i>	127
Rotelle ad una e due corone di sfere <i>Wheels with single or double row rollers</i>	137
Cuscinetti radiali a rullini ed assiali a rulli cilindrici <i>Radial needle roller bearings and axial cylindrical needle roller bearings</i>	143
Cuscinetti radiali a rulli cilindrici a pieno riempimento <i>Cylindrical roller bearings, full complement roller</i>	151
Pattini a rulli <i>Recirculating linear roller bearings</i>	169
Rullini <i>Needle rollers</i>	173
Anelli di tenuta per bussole di scorrimento (serie VB - VC - VCW) <i>Seals for sliding ball bushing (VB - VC - VCW series)</i>	177
Anelli elastici <i>Elastic rings</i>	187
Cuscinetti per movimentazione lineare <i>Linear bearings</i>	195

3

GENERALITÀ

GENERALITY

Sono numerosi i fattori da considerare per effettuare una scelta corretta di un cuscinetto; di seguito sono elencati i principali fattori che possono influenzare tale scelta:

- carichi effettivi ed eventuali urti
- velocità di rotazione
- temperatura di funzionamento
- durezza delle piste di rotolamento
- durezza dei rullini
- lubrificazione

Many factors have to be considered while choosing a bearing, these are:

- real loads and possible crashes
- rotation speeds
- working temperature
- hardness of rolling grooves
- hardness of needle rollers
- lubrication

4

COEFFICIENTI DI CARICO

LOAD RATINGS

4.1

COEFFICIENTE DI CARICO DINAMICO C

BASIC DYNAMIC LOAD RATING C

Il coefficiente di carico dinamico C di un cuscinetto è il carico radiale costante che il cuscinetto può sopportare per un milione di giri. Il coefficiente di carico dinamico C di cuscinetti con gabbia e dei reggispinta riportati nelle tabelle dimensioni, seguono le Norme Generali ISO, quindi si raccomanda di attenersi a quest'ultime per un corretto utilizzo.

The "basic dynamic load rating" C, is the constant radial load that a bearing is able to stand for one million revolutions. The "basic dynamic load" C of both thrust bearings and caged bearings included in dimensions tables, is in accordance with international ISO requirements so, in order to obtain a correct use, we recommend to follow those.

4.2

COEFFICIENTE DI CARICO STATICO C₀BASIC STATIC LOAD RATING C₀

Il coefficiente di carico statico C₀ è considerato solo quando esiste un carico, ma in assenza di rotazione. Per i cuscinetti radiali, il carico è espresso in direzione radiale, mentre per i cuscinetti assiali il carico è espresso in direzione assiale (considerando il carico centrato), per il quale la pressione tra i corpi volventi e le piste di rotolamento raggiungono i seguenti valori:

- 4.000 N/mm² per i cuscinetti a rulli ed a rullini
- 4.200 N/mm² per i cuscinetti a sfere

Nelle condizioni sopra indicate, il coefficiente di carico statico C₀, corrisponde approssimativamente alla deformazione dell'elemento volvente più caricato ed alla deformazione di una delle piste di rotolamento uguale a 1/10.000 del diametro del corpo volvente. Quanto sopra espresso è da considerarsi valido in condizioni normali d'impiego e la deformazione può essere tollerata, senza che sia pregiudicata l'efficienza di funzionamento.

The basic static load rating C₀ is considered only in case of load with absence of revolution. For radial bearings the load is expressed in radial direction, whereas for axial bearings load is expressed in axial direction (centred load). Pressure between balls, rollers and racing lines reaches the following values:

- 4.000 N/mm² for tapered and needle roller bearings
- 4.200 N/mm² for ball bearings

At these conditions, C₀ static load rating corresponds to a deformation of the roller and the raceway, at the most heavily stressed contact of 1/10.000 of the roller diameter.

This rule is valid only in case of standard working conditions. For this reason a deformation can be accepted as it doesn't hinder functioning.

5

CALCOLO DELLA DURATA

CALCULATION OF THE RATING LIFE

La durata nominale viene calcolata nel seguente modo:

$$L_{10} = \left(\frac{C}{P}\right)^p$$

Nominal duration is calculated as follows:

$$L_{10h} = \frac{1.000.000}{60 N} \left(\frac{C}{P}\right)^p$$

- L = durata teorica, in milioni di giri
- L_h = durata teorica, in ore di funzionamento
- C = coefficiente di carico dinamico (in kg)
- P = carico dinamico equivalente agente sul cuscinetto (in kg)
- C/P = rapporto di carico
- p = esponente di durata (p=10/3 per cuscinetti a rullini ed a rulli cilindrici p=3 per cuscinetti a sfere)
- n = numero di giri di funzionamento

È importante sottolineare che per i cuscinetti combinati (cuscinetti a rullini con singola corona radiale di sfere e cuscinetti a rullini con singola corona assiale di sfere) le durate devono essere calcolate separatamente in base ai rispettivi coefficienti di carico dinamico indicati nelle tabelle seguenti.

- L = nominal rating life, in million revolutions
- L_h = nominal rating life, in operating hours
- C = dynamic load rating, expressed in kilos
- P = dynamic equivalent load on bearing, expressed in kilos
- C/P = load ratio
- p = life exponent (p=10/3 for needle roller bearings and roller bearings p=3 for ball bearings)
- n = number of working revolutions

It is very important concerning combined bearings (single row radial ball needle bearings and single row axial ball needle bearings), to remember that durations have to be separately calculated by following respective basic dynamic load ratings indicated in the following tables.



5.1

DURATA TEORICA RICHIESTA

RATING LIFE REQUESTED

Nei casi in cui occorre effettuare una scelta su quale tipologia di cuscinetto adottare nelle diverse applicazioni, sarà importante valutare qual'è il tempo di durata dell'utilizzo dell'attrezzatura e se viene usata in modo continuo o ad intermittenza. In mancanza d'esperienza si può assumere come base la sottoindicata tabella:

Ore di funzionamento	Tipologia di strumento
• da 4.000 a 8.000	- apparecchi per lavori domestici, macchine agricole (macchine con funzionamento intermittente per le quali eventuali interruzioni hanno poca importanza).
• da 8.000 a 12.000	- macchine utensili impiegate saltuarimente, motori per elettrodomestici, apparecchi di manipolazione (macchine con funzionamento breve per le quali eventuali interruzioni possono avere importanza).
• da 12.000 a 24.000	- macchine utilizzate tutto il giorno anche se non continuamente (motori elettrici, ingranaggi vari).
• da 24.000 a 30.000	- macchine utilizzate tutto il giorno, in modo continuo, macchine utensili e varie per l'industria.
• da 30.000 a 1000.000 ed oltre	- macchine funzionanti 24 ore al giorno richiedenti la massima affidabilità, pompe, compressori, macchine da stampa, generatori d'energia, acquedotti

Sometimes it is necessary to make a choice about type of bearing to use in different applications, in this case it is important to estimate how long the machinery will be used for and if its work is continuous or intermittent. When a lack of experience is present, the following table can be used:

Operating hours	Kind of instrument
• from 4.000 to 8.000	- domestic apparatus, agricultural machinery (devices with an intermittent work where possible breaking off are not important)
• from 8.000 to 12.000	- machinery tools jerkily used, electrical households, handling apparatus (devices with a short working time where possible breaking off can be important)
• from 12.000 to 24.000	- machinery used all day long even if not continually (i.g. electric motors, gears)
• from 24.000 to 30.000	- all day working machinery in a continuous way, different apparatus for industries and machinery tools
• from 30.000 to 1000.000	- 24 hours a day operating and over machinery requiring maximum reliability such as pumps, compressors, printing machinery, water main suppliers, energy generators.

5.2

DURATA D'ESERCIZIO

OPERATING LIFE

Con durata d'esercizio s'intende il limite massimo di durata che il cuscinetto raggiunge nell'applicazione.

È normale che calcolare la durata d'esercizio può risultare abbastanza complicato in quanto le varianti che possono influire sulla durata sono molteplici, a partire da disassamenti tra albero ed alloggiamento, lubrificazione, temperatura d'esercizio. È raccomandabile dove è possibile avvalersi sempre di esperienze precedenti.

With operating life, we mean the operating limit that a bearing achieves during its application. To calculate the duration can be very difficult as many different factors can influence the life, for example misalignment between shaft and housing, lubrication, operating temperature.

To have more information, where possible, we recommend to see previous applications.

5.3

CARICO STATICO EQUIVALENTE P_0 EQUIVALENT STATIC LOAD P_0

Il carico statico equivalente P_0 , è limitato dal coefficiente di sicurezza statico S_0 , ed è da intendersi come carico radiale per cuscinetti radiali a carico assiale e centrato per cuscinetti assiali, da cui:

• Cuscinetti a rullini di tipo radiale

$$P_0 = F_r$$

in cui P_0 = carico statico equivalente (in kg.)

F_r = carico radiale effettivo (in kg.)

• Cuscinetti a rullini di tipo assiale

$$P_0 = F_a$$

in cui F_a = carico assiale effettivo (in kg.)

Equivalent static load P_0 , is limited by static safety coefficient S_0 , P_0 means radial load for radial bearings and axial centred load for axial bearings, therefore:

• Radial needle roller bearings

$$P_0 = F_r$$

where P_0 = equivalent static load (expressed in kilos)

F_r = real radial load (expressed in kilos)

• Axial needle roller bearings

$$P_0 = F_a$$

where F_a = real axial load (expressed in kilos)

5.4

CARICO DINAMICO EQUIVALENTE P

EQUIVALENT DYNAMIC LOAD P

Il carico dinamico equivalente P su di un cuscinetto radiale o reggisplinta viene solitamente determinato partendo dalle caratteristiche della macchina e/o attrezzatura sul quale viene utilizzato. Risulta spesso determinante tener conto dei carichi accidentali che possono nascere dall'utilizzo della macchina stessa, quindi vibrazioni, urti, sovraccarichi degli organi. Da ciò ne consegue che calcolare il carico effettivo può risultare complicato, in quanto occorre considerare diversi fattori, per cui si deduce che le esperienze precedenti di montaggio sono sempre la miglior guida. Inoltre occorre fare una distinzione tra cuscinetti di tipo assiale e radiale sui quali per calcolare il carico dinamico equivalente possiamo usare le seguenti formule:

• **Cuscinetti a rullini di tipo radiale (considerando Fr costante)**

$$P = Fr$$

in cui P = carico dinamico equivalente (in kg.)
Fr = carico radiale effettivo (in kg.)

• **Cuscinetti a rullini di tipo assiale (considerando il carico centrato)**

$$P = Fa$$

in cui Fa = carico assiale effettivo (in kg.)

The equivalent dynamic load P on a radial or thrust bearing, is usually determined by starting from characteristics of the machinery and/or of the special equipment on which it is assembled. It is often important to keep present accidental loads that a machinery is able to produce during its work, such as vibrations, impacts, overloads. It's clear that the calculation of real load can be very hard and at the light of this we recommend once again, where possible, to see previous applications. A further distinction between axial and radial bearings, has to be made: the following formula can be used to determinate equivalent dynamic load:

• **Radial needle roller bearings (where Fr is constant)**

$$P = Fr$$

where P = equivalent dynamic load (expressed in kilos)
Fr = real radial load (expressed in kilos)

• **Axial needle roller bearings (load is centred)**

$$P = Fa$$

where Fa = real axial load (expressed in kilos)

5.5

COEFFICIENTE DI SICUREZZA STATICO S₀STATIC LOAD SAFETY FACTOR S₀

La capacità di carico statico non è altro che la capacità di un cuscinetto di sopportare dei carichi applicati in assenza di movimento, oppure in presenza di oscillazioni molto lente. Tali carichi possono ugualmente creare delle deformazioni, a volte permanenti, anche se in alcuni casi possono essere considerate accettabili. Da qui il concetto di coefficiente di sicurezza statico, che indica il grado di sicurezza del cuscinetto contro eventuali deformazioni. Il coefficiente di sicurezza statico, può essere ricavato dalla seguente formula:

$$S_0 = \frac{C_0}{P_0}$$

considerando che:

S₀ - fattore di sicurezza statico

C₀ - coefficiente di carico statico (in kg)

P₀ - carico ammissibile (in kg)

The static load ability of a bearing is its ability to stand loads when there is no movement at all or when the oscillations are very slow. Even in these cases loads can produce deformations, sometimes permanent, even if rather acceptable in some applications. Here comes the static coefficient of safety, able to indicate the safety degrees of a bearing against deformations. Static load safety factor, can be calculated by using the following formula:

where:

S₀ - static factor of safety

C₀ - static load rating, in kilos

P₀ - possible load, in kilos

Valori indicativi del coefficiente di sicurezza statico S ₀ S ₀ static safety load rating coefficient	Cuscinetti a rulli e rullini Roller and needle bearings	Cuscinetti a sfera Ball bearings
Condizioni operative - Working conditions		
Elevata precisione di rotazione, con carichi ed urti High rotation precision, with heavy loads and impacts	3	2
Precisione normale di rotazione, con maggiori esigenze di silenziosità Normal rotation precision, with greater need of noiselessness	1,5	1
Precisione di rotazione limitata, bassi carichi, minime esigenze di silenziosità Low rotation precision, low loads and minimal need of noiselessness	1	0,5



6

INFLUENZA DELLA TEMPERATURA D'ESERCIZIO

INFLUENCE OF OPERATING TEMPERATURE

E' importante sempre e comunque tener conto della temperatura d'esercizio al quale viene sottoposto un cuscinetto a rullini durante il suo impiego, in quanto al variare della temperatura possono variare le condizioni del cuscinetto: ad esempio quando si lavora a temperature d'esercizio molto elevate la durezza del materiale del cuscinetto varia, quindi da qui possiamo già comprendere che il carico che sopporterà il cuscinetto sarà sicuramente inferiore. Operando con temperature superiori ai 120° sia i coefficienti di carico dinamico che statico subiranno dei cambiamenti, diminuendo le capacità di carico effettive. (Per i cuscinetti con tenute RS e 2RS si consiglia di non superare i + 80 °C).

Per applicazioni in cui sia presente una temperatura d'esercizio di circa 120° o più, sarebbe opportuno sottoporre il cuscinetto, o più precisamente gli anelli, a trattamenti termici di stabilizzazione, evitando così che possano insorgere variazioni dimensionali di una certa entità e quindi in grado di compromettere l'utilizzo corretto dei cuscinetti a rullini.

Un'altra componente fondamentale per un corretto utilizzo dei cuscinetti a rullini, è sicuramente la lubrificazione, in quanto soprattutto a temperature elevate, l'uso di un grasso o di un olio non adatto può sicuramente influire sul buon funzionamento del cuscinetto causando surriscaldamento ed eccessiva usura. Seguiranno nei capitoli successivi spiegazioni più dettagliate sulla lubrificazione ad olio od a grasso.

It's always important to consider operating temperature of a bearing during its work: if temperature changes bearing conditions do the same.

For instance, the hardness of bearing material changes when there is an application requiring very high temperatures: in this case the bearing is able to stand lower load.

In case of applications where temperatures are higher than 120° both static and dynamic load rating change: the real load ability will be lower (for RS and 2RS bearings, we suggest not to exceed 80 °C)

During applications where temperature is 120° and more, it is better to submit the bearing or better, its rings, to some thermal treatments to stabilisation, avoiding in this way possible strong dimensional changes that could compromise the right use of needle roller bearings.

Lubrication is another basic factor for a correct use of bearings: where temperatures are high the utilisation of a wrong grease or oil can influence good work of bearing, by causing overheating or excessive wear.

Details concerning lubrication in the following chapters.

7

STRUTTURA DELLE PISTE DI ROTOLAMENTO

MATERIALS FOR ROLLING BEARING RACEWAYS

Per i cuscinetti a rullini, gabbie a rullini ecc. che vengono montati senza anello interno od esterno quindi che utilizzano l'albero come sede di scorrimento, sarà opportuno fare in modo che le piste di rotolamento ed i rullini abbiano entrambi una durezza compresa tra i 58 ed i 64 HRC. Se le piste di scorrimento hanno una durezza inferiore ai valori sopraindicati si deduce che la capacità di carico diminuisce ed aumenta l'usura. A tal proposito si può ricorrere alla tabella sottoindicata, moltiplicando il coefficiente di carico dinamico per il corrispondente valore di durezza della pista di rotolamento:

Durezza (espressa in HRC)

60 58 55 50 48 45 40 35 30 25

Fattori di riduzione dei carichi

1 1 0,7 0,55 0,48 0,41 0,32 0,24 0,17 0,11

Nella scelta più adeguata del materiale di costruzione delle piste di rotolamento possono essere impiegati gli acciai legati con un grado di purezza corrispondente, come ad esempio:

- Acciai di tutta tempra
- Acciai da cementazione
- Acciai per tempra alla fiamma o ad induzione

For needle roller bearings and needle roller cages assembled without inner or outer ring and able therefore to use the shaft as sliding place, both rolling bearing raceways and roller must have an hardness included between 58 and 64 HRC. If rolling grooves do not reach this target, their loading ability decreases and wear increases.

The following table can be used by multiplicand basic dynamic load rating for correspondent factor of hardness of rolling bearing raceways:

Hardness (expressed in HRC)

60 58 55 50 48 45 40 35 30 2

Loads reduction factors

1 1 0,7 0,55 0,48 0,41 0,32 0,24 0,17 0,11

During the choice of materials that will be used for manufacturing rolling bearing raceways, different kind of steel can be used, obviously they have a different kind of purity, these are:

- all tempering steels
- tempering surface steels
- fire tempering steels or induction tempering steels

8

NUMERO DI GIRI E VELOCITÀ MASSIMA AMMISSIBILE

NUMBER OF REVOLUTIONS AND MAXIMUM SPEED ALLOWED

La velocità massima ammissibile di rotazione di un cuscinetto volvente dipende da numerosi fattori, che devono essere tutti considerati per avere un dato abbastanza attendibile. Di seguito elencheremo quelle che sono le variabili più importanti da considerare per sapere il numero di giri massimo che può sopportare un cuscinetto volvente:

- **tipo di cuscinetto** (forma e dimensioni).
- **carico**
- **lubrificazione** (olio o grasso).
- **fattore di raffreddamento**

In altri casi possono essere determinanti diversi altri fattori come ad esempio la silenziosità e la funzione di tenuta, purchè come presupposto siano stati rispettati i seguenti criteri:

- **montaggio corretto**
- **giuoco d'esercizio normale**
- **condizioni costanti di funzionamento**

Occorre puntualizzare che in applicazioni speciali dove è necessario oltrepassare il numero di giri ammissibile è opportuno prendere accorgimenti particolari come ad esempio una lubrificazione a circolazione d'olio.

Per velocità di rotazione molto elevate è opportuno usare una lubrificazione come la sopraindicata ma integrandola con un dispositivo di raffreddamento dell'olio o nei casi estremi una lubrificazione a nebbia o ad iniezione d'olio. In applicazioni particolari è consigliabile anche l'utilizzo di gabbie speciali.

Limiting speed of a bearing depends on many factors: all of them have to be considered in order to have reliable specifications.

Here the most important factors able to influence limiting speeds:

- **type of bearing** (shape and dimension)
- **load**
- **lubrication** (oil or grease)
- **cooling factor**

In other cases it is also important low noise property and seal ability if the following rules are respected:

- **right assembling**
- **normal clearance**
- **constant work conditions**

An oil lubrication is required when special applications are present and higher number of revolutions than those allowed, have to be reached.

In case of very high rotation speeds, besides using an oil lubrication, a cooling oil device must be used as long as a "fog lubrication" or an "oil injection".

Particular cages must be used in case of special applications.

9

LUBRIFICAZIONE

LUBRICATION

La lubrificazione è sicuramente uno dei fattori più importanti per il buon funzionamento di un cuscinetto, in quanto impedisce l'insorgere di attrito tra i corpi volventi, gli anelli e la gabbia, inoltre costituisce una protezione notevole per alcuni agenti esterni come polvere od umidità evitando corrosione ed usura.

Il quantitativo di prodotto lubrificante per i cuscinetti è decisamente piccolo, a meno che non abbia compiti particolari di tenuta o di dissipazione del calore.

La lubrificazione può avvenire utilizzando sia del grasso che dell'olio. (Seguirà specifico capitolo sulla lubrificazione ad olio e grasso). Occorre specificare che sia il grasso che l'olio che si andranno ad utilizzare devono essere sempre privi di qualsiasi impurità, in quanto anche un granello di sabbia od una piccola particella di metallo possono portare al danneggiamento del cuscinetto. Il lubrificante con il tempo perde l'efficacia del servizio, per questo si raccomanda di aggiungere periodicamente il lubrificante necessario al buon funzionamento del cuscinetto, cercando sempre di tener presente tutte quelle variabili di funzionamento e le particolari condizioni d'esercizio (polvere, umidità, temperatura eccessiva). Naturalmente per i cuscinetti con lubrificazione a vita non sarà necessario preoccuparsi della lubrificazione, in quanto sono stati studiati per applicazioni particolari dove non è possibile effettuare alcuna rilubrificazione periodica.

Lubrication is one of the most important operations effecting bearing life, as it prevents friction among rolling elements, rings and cage, and it protects against external factors such as dust and humidity avoiding therefore wear and tear.

The quantity of lubricant for a bearing is really small, unless it has to bear particular sealing duties or heat dissipation.

Either grease or oil may be used: each has its advantages and limitations (see specific chapter for lubrication).

Both grease and oil have to be devoid of any impurity: even a grind of sand or a small metal particle could damage the bearing.

Lubricant loses its efficacy while passing the time, this is the reason why we recommend to top it up periodically: a good upkeep help the bearing to have a good functioning.

Life self lubricated bearings do not require any upkeep, as they are purposely studied for special applications where relubrication is not possible.

9.1
LUBRIFICAZIONE A GRASSO
GREASE LUBRICATION

Il grasso utilizzato come lubrificante presenta dei vantaggi, oppone una resistenza maggiore all'ossidazione ed al formarsi di ruggine e permette di avere meno dispersione durante l'utilizzo del cuscinetto. Solitamente la scelta di effettuare una lubrificazione con grasso piuttosto che con olio prevede una velocità ed una temperatura d'esercizio meno elevata. Dalle tabelle dei singoli cuscinetti presentati in questo catalogo è possibile vedere le diverse velocità d'esercizio. Per effettuare una scelta adeguata del grasso da utilizzare risulta importante prendere in considerazione i seguenti criteri:

- **Temperatura d'esercizio** - (Il campo di temperatura di un grasso deve essere leggermente superiore al campo della temperatura d'esercizio del cuscinetto.

E' consigliabile non raggiungere mai la massima e la minima temperatura d'esercizio).

- **Tipologia del grasso** - (Vedi tabella sottoindicata).
- **Caratteristiche generali del grasso** (idrorepellenza, conservazione, compatibilità)
Per quel che concerne la conservazione del grasso presente nei cuscinetti, risulta molto importante attenersi alle specifiche dei produttori, in quanto in particolari condizioni non è possibile garantire una durata superiore a circa 3 anni, a meno che non vengano rispettate le seguenti condizioni indispensabili:

- **tipologia dell'ambiente** (ambiente chiuso)
- **umidità** (max 70% nell'aria)
- **temperatura min 0° - max. 40°**
- **imballo del cuscinetto**
- **contaminazione da fattori esterni** (gas, polvere, vapori ecc.)

Se il cuscinetto rimane inutilizzato per un periodo superiore a quello indicato, potrebbe presentare un maggior attrito al momento dell'utilizzo, ma ciò non dovrebbe impedirne l'uso a meno che non siano state rispettate le necessarie precauzioni per una corretta conservazione. Nei casi che il grasso dovesse presentare dei problemi di lubrificazione dovuti ad un eventuale essiccazione, si può ricorrere al lavaggio del cuscinetto e rilubrificarlo con la stessa quantità di grasso impiegata all'origine od al primo montaggio. Per effettuare una corretta rilubrificazione, occorre che il cuscinetto sia in temperatura di funzionamento ed in rotazione, possibilmente prima dell'arresto della macchina. Si consiglia di utilizzare una quantità di grasso dal 20% all'80% di quella iniziale.

Grease used as lubricant, besides having less waste, brings different advantages such as a bigger endurance against oxidation and rust.

Grease lubrication requires lower speed and temperature.

For different operating speeds, check bearings tables.

The following factors have to be studied before choosing the correct type of grease:

- **Operating temperature** (the field of a grease temperature has to be higher than the bearing ones; it is important to avoid reaching maximum and minimum operating temperature)

- **Kind of grease** (see table below)

- **General grease characteristics** (i.g. waterproofs, preservation, miscibility)

Concerning grease preservation, it is important to follow manufacturers indications: in fact where particular conditions are present, longest life is 3 years, unless following conditions are respected:

- **kind of surrounding** (must be closed)
- **humidity** (not more than 70% in the air)
- **lowest temperature 0°- highest 40°**
- **packing of bearing**
- **external factors contamination** (dust, gas, steam...)

If the bearing doesn't work for a longer period, a greater friction could be present at the time of using, this shouldn't prevent its use unless the conditions for a correct preservation haven't been respected.

The grease can sometimes suffer problems caused by drying: we suggest to wash the bearing and re-lubricate it with the same original quantity of lubricant.

To carry out a correct re-lubrication, the bearing has to be in movement and in temperature: possibly before stopping the machinery.

Quantity of grease suggested is from 20% to 80% of the initial one.

Marca e tipo Brand and type	Grasso base Basic type grease	Temperatura d'esercizio Operating temp C	Caratteristiche Uses
Exxon Beacon 325	Grasso sintetico Synthetic grease	- 55 to +120	Grasso generico General purpose grease
Exxon Andok B (Mil-G-18709A)	Grasso da petrolio Channeling petroleum grease	- 30 to +100	Eccellente alle alte velocità e bassi carichi Excellent high speeds low torque qualities
Exxon Andok C	Grasso da petrolio Channeling petroleum grease	- 30 to +120	Alta scorrevolezza, lunga durata Smooth running, long life with minimum migration
Chevron SRI-2	Minerale Mineral grease	- 35 to +180	Per alte temperature buona resistenza all'acqua High temperature range with good water resistance
Shell Alvania 2	Minerale Mineral grease	- 35 to +120	Lunga durata Long life
KYODO SRL	Sintetico Synthetic grease	- 40 to +150	Bassa rumorosità e bassi carichi Low noise and low torque applications

9.2

LUBRIFICAZIONE AD OLIO

OIL LUBRICATION

La lubrificazione ad olio viene solitamente utilizzata quanto si è in presenza di applicazioni che necessitano di raggiungere alte velocità e carichi elevati richiedenti dispersione del calore dei cuscinetti, o quando le parti adiacenti sono già lubrificate con olio. In linea di massima si consiglia l'utilizzo di olii minerali raffinati senza additivi. Per applicazioni particolari si possono utilizzare olii con additivi ma anche olii di tipo sintetico, consigliati soprattutto per il raggiungimento di temperature elevate. In linea di massima sarebbe opportuno scegliere un olio lubrificante che presenti una viscosità che assicuri alla temperatura di funzionamento un valore che non scenda al di sotto dei 12mm²/s.

Se vengono effettuate applicazioni speciali, dove si raggiungono valori molto elevati in numero di giri è consigliabile utilizzare olii fluidi in grado di garantire la massima fluidità e quindi il minor attrito dei corpi volventi.

Oil lubrication is usually required in presence of special applications requiring high speeds and of loads requiring leak of heat, or when adjacent parts are already oil lubricated.

As a general rule we recommend to use mineral oils, purified without additives.

For special applications both oils with additive and synthetic oils can be used, these latter are particularly indicated to reach high temperatures.

However the best choice will be a lubricant with a viscosity able to ensure operating temperature with a value not lower than 12mm²/s.

In case of special applications where very high speeds are reached, light oils must be used: these are able to guarantee top fluidity and lowest friction, besides a lower development of heat.

9.3

TIPI DI LUBRIFICAZIONE AD OLIO

KINDS OF OIL LUBRICATION

La scelta del tipo di lubrificazione da utilizzare dipende soprattutto dall'applicazione che si deve effettuare e dalle velocità che il cuscinetto deve raggiungere. Andremo qui di seguito ad elencare quelle che sono le diverse tipologie di lubrificazione più utilizzate:

Applications and speeds influence the type of lubrication to choose, here the most important types of it:

9.3.1 Lubrificazione a goccia d'olio: viene utilizzata per i cuscinetti radiali, garantisce un elevato numero di giri, ma è utilizzabile solo nel caso in cui il cuscinetto sia fornito di foro di lubrificazione nell'anello esterno

9.3.1 Drip feed oil lubrication: for axial bearings, it guarantees high number of revolutions; bearings have to be supplied with lubrication hole on the outer ring.

9.3.2 Lubrificazione a bagno d'olio: viene anche definita con altri nomi (ad immersione o coppa d'olio), viene solitamente utilizzata per basse velocità, circa la metà dei giri che il cuscinetto può realmente raggiungere.

9.3.2 Oil bath lubrication: generally known as immersion or bowl oil. It's mostly used for low speeds, i.g. half revolutions of bearing ability.

E' adatta ai montaggi in asse orizzontale, il livello del bagno con cuscinetto fermo deve raggiungere il punto più basso della pista interna di rotolamento. La quantità d'olio non deve essere troppo scarsa, in quanto tale mancanza potrebbe creare degli intervalli di cambio d'olio troppo ridotti, inoltre si raccomanda un controllo costante del livello dell'olio attraverso apposito indicatore.

Suitable for horizontal axle mounting the level of oil must reach the lowest point of inner rolling grooves, bearing has to stand still.

Oil quantity doesn't have to be too poor to avoid reducing gaps during oil changes, besides a constant check of oil level by appropriate indicator is required.

9.3.3 Lubrificazione a circolazione d'olio: viene utilizzata quando si raggiungono velocità e temperature alte, questo dovrebbe garantire una minor usura del cuscinetto e un minor ricambio d'olio. Attraverso un filtraggio è possibile mantenere la temperatura di funzionamento bassa.

9.3.3 Recirculating oil lubrication: requested when very high speeds and revolutions must be reached: this method guarantees lower wear and infrequent substitution of oil. Thanks to a filtration it is possible to keep low temperatures.

9.3.4 Lubrificazione a nebbia d'olio: viene utilizzata quando si devono raggiungere alte velocità di rotazione, in quanto questo sistema di lubrificazione funziona attraverso l'iniezione di piccole quantità d'olio dosabili, polverizzato in una corrente d'aria. Si precisa che l'aria dovrà essere secca e priva di qualsiasi impurità. La sovrappressione che si viene a creare all'interno della macchina dovrebbe garantire l'esclusione di qualsiasi agente inquinante esterno, come polvere, detriti, vapori, umidità ecc.

9.3.4 Fog oil lubrication: required when high revolutions speeds must be reached.

This system works thanks to the injection of very small quantity of oil, which will be pulverised in a draught.

The air must be pure and free from any impurity.

The overpressure created in this way, should guarantee the exclusion of any external contaminating factors such as dust, humidity, steam, rubble

9.3.5 Lubrificazione ad olio centralizzata: viene utilizzata quando esiste la necessità di dover lubrificare delle attrezzature in diversi punti, solitamente quest'operazione avviene attraverso una pompa centralizzata che provvede alla distribuzione dell'olio nei vari reparti interessati. Ha sicuramente il vantaggio di offrire un maggior controllo della dose del liquido di lubrificazione ed il filtraggio.

9.3.5 Centralised oil lubrication: necessary when there is a need of lubricating the equipment in different points, usually it's a centralised pump that distributes oil among different interested parts.

It offers a control about the level of liquid used for lubrication by a filtration.

10

TABELLE DELLE TOLLERANZE

TOLERANCES TABLES

Le tolleranze dei cuscinetti sono state normalizzate a livello sia nazionale che internazionale ai sensi delle norme ISO. I cuscinetti vengono in genere costruiti in classe di tolleranza P0. Su richiesta, possono inoltre essere costruiti in classi di tolleranza P6, P5, P4 e P2. Questi ultimi cuscinetti vengono impiegati per applicazioni speciali, quali guida di alta precisione di alberi o altissime velocità di rotolamento.

In accordance with ISO rules bearing tolerances have been nationally and internationally standardized. Bearings are usually manufactured to the tolerance class P0.

Under request, they can be supplied with P6, P5, P4 and P2 tolerance classes.

These latter bearings are used for special applications, such as very high speeds or very accurate shaft guidance.

Classe di tolleranza normale P0 P0 normal tolerance class

Anello interno (valori tolleranza in μm) - Inner ring (tolerance values in μm)

d mm		Δd_{mp} scostamento / deviation		V_{Dp} serie diametrali / diameter series			V_{dpm}	ΔB_S scostamento / deviation		V_{BS}	K_{ia}
oltre over	fino a up to	max	min	8,9 max	0 max	2,3 max	max			max	max
2,5	10	0	-8	10	8	6	6	0	-120	15	10
10	18	0	-8	10	8	6	6	0	-120	20	10
18	30	0	-10	13	10	8	8	0	-120	20	13
30	50	0	-12	15	12	9	9	0	-120	20	15
50	80	0	-15	19	19	11	11	0	-150	25	20
80	120	0	-20	25	25	15	15	0	-200	25	25
120	180	0	-25	31	31	19	19	0	-250	30	30
180	250	0	-30	38	38	23	23	0	-300	30	40
250	315	0	-35	44	44	26	26	0	-350	35	50
315	400	0	-40	50	50	30	30	0	-400	40	60
400	500	0	-45	56	56	34	34	0	-450	50	65
500	630	0	-50	63	63	38	38	0	-500	60	70
630	800	0	-75	-	-	-	-	0	-750	70	80
800	1 000	0	-100	-	-	-	-	0	-1 000	80	90
1 000	1 200	0	-125	-	-	-	-	0	-1 250	100	100

Anello esterno (valori tolleranza in μm) - Outer ring (tolerance values in μm)

D mm		ΔD_{mp} scostamento / deviation		V_{Dp} serie diametrali / diameter series			V_{Dpm}^*	K_{ea}	ΔC_S	V_{CS}
oltre over	fino a up to	max	min	8,9 max	0 max	2,3 max	max	max		
6	18	0	-8	10	8	6	6	15	Uguale a ΔB_S e V_{BS} per anello interno dello stesso cuscinetto. <i>Identical to ΔB_S and V_{BS} of the inner ring of the relevant bearing.</i>	
18	30	0	-9	12	9	7	7	15		
30	50	0	-11	14	11	8	8	20		
50	80	0	-13	16	13	10	10	25		
80	120	0	-15	19	19	11	11	35		
120	150	0	-18	23	23	14	14	40		
150	180	0	-25	31	31	19	19	45		
180	250	0	-30	38	38	23	23	50		
250	315	0	-35	44	44	26	26	60		
315	400	0	-40	50	50	30	30	70		
400	500	0	-45	56	56	34	34	80		
500	630	0	-50	63	63	38	38	100		
630	800	0	-75	94	94	55	55	120		
800	1 000	0	-100	125	125	75	75	140		
1 000	1 250	0	-125	-	-	-	-	160		
1 250	1 600	0	-160	-	-	-	-	190		

* Valido prima dell'assemblaggio del cuscinetto e solo dopo aver smontato gli anelli elastici interni ed esterni
Applies before assembly of the bearing and after removed of internal and external snap rings

Classe di tolleranza P5 P5 tolerance class

Anello interno (valori tolleranza in μm) - Inner ring (tolerance values in μm)

d mm		Δd_{mp} scostamento / deviation		V_{dp} serie diametrali / diameter series		V_{dpm}	K_{ia}	ΔB_S scostamento / deviation		V_{BS}
oltre over	fino a up to	max	min	8,9 max	0, 2, 3 max	max	max	superiore hupper	inferiore lower	max
2,5	10	0	-5	5	4	3	4	0	-40	5
10	18	0	-5	5	4	3	4	0	-80	5
18	30	0	-6	6	5	3	4	0	-120	5
30	50	0	-8	8	6	4	5	0	-120	5
50	80	0	-9	9	7	5	5	0	-150	6
80	120	0	-10	10	8	5	6	0	-200	7
120	180	0	-13	13	10	7	8	0	-250	8
180	250	0	-15	15	12	8	10	0	-300	10
250	315	0	-18	18	14	9	13	0	-350	13
315	400	0	-23	23	18	12	15	0	-400	16

Anello esterno (valori tolleranza in μm) - Outer ring (tolerance values in μm)

D mm		ΔD_{mp} scostamento / deviation		V_{Dp} serie diametrali / diameter series		V_{Dpm}^*	K_{ea}	S_D	ΔC_S	V_{CS}
oltre over	fino a up to	max	min	8,9 max	0, 2, 3 max	max	max	max		
6	18	0	-5	5	4	3	5	8	Ugual a ΔB_S e V_{BS} per anello interno dello stesso cuscinetto. <i>Identical to ΔB_S and V_{BS} of the inner ring of the relevant bearing.</i>	5
18	30	0	-6	6	5	3	6	8		5
30	50	0	-7	7	5	4	7	8		5
50	80	0	-9	9	7	5	8	8		6
80	120	0	-10	10	8	5	10	9		8
120	150	0	-11	11	8	6	11	10	8	
150	180	0	-13	13	10	7	13	10	8	
180	250	0	-15	15	11	8	15	11	10	
250	315	0	-18	18	14	9	18	13	11	
315	400	0	-20	20	15	10	20	13	13	
400	500	0	-23	23	17	12	23	15	15	
500	630	0	-28	28	21	14	25	18	18	
630	800	0	-35	35	26	18	30	20	20	

* Valido prima dell'assemblaggio del cuscinetto e solo dopo aver smontato gli anelli elastici interni ed esterni
Applies before assembly of the bearing and after removed of internal and external snap rings

Classe di tolleranza P6 - P6 tolerance class

Anello interno (valori tolleranza in μm) - Inner ring (tolerance values in μm)

d mm		Δd_{mp} scostamento / deviation		V_{Dp} serie diametrali / diameter series			V_{dpm}	K_{ia}	ΔB_S scostamento / deviation		V_{BS}
oltre over	fino a up to	max	min	8,9 max	0 max	2, 3 max	max	max	superiore upper	inferiore lower	max
2,5	10	0	-7	9	7	5	5	6	0	-120	15
10	18	0	-7	9	7	5	5	7	0	-120	20
18	30	0	-8	10	8	6	6	8	0	-120	20
30	50	0	-10	13	10	8	8	10	0	-120	20
50	80	0	-12	15	15	9	9	10	0	-150	25
80	120	0	-15	19	19	11	11	13	0	-200	25
120	180	0	-18	23	23	14	14	18	0	-250	30
180	250	0	-22	28	28	17	17	20	0	-300	30
250	315	0	-25	31	31	19	19	25	0	-350	35
315	400	0	-30	38	38	23	23	30	0	-400	40
400	500	0	-35	44	44	26	26	35	0	-450	45
500	630	0	-40	50	50	30	30	40	0	-500	50

Anello esterno (valori tolleranza in μm) - Outer ring (tolerance values in μm)

D mm		ΔD_{mp} scostamento / deviation		V_{Dp} serie diametrali / diameter series			V_{Dpm}^*	K_{ea}	ΔC_S	V_{CS}
oltre over	fino a up to	max	min	8,9 max	0 max	2, 3 max	max	max		
6	18	0	-7	9	7	5	5	8		
18	30	0	-8	10	8	6	6	9		
30	50	0	-9	11	9	7	7	10		
50	80	0	-11	14	11	8	8	13		
80	120	0	-13	16	16	10	10	18		
120	150	0	-15	19	19	11	11	20		
150	180	0	-18	23	23	14	14	23		
180	250	0	-20	25	25	15	15	25		
250	315	0	-25	31	31	19	19	30		
315	400	0	-28	35	35	21	21	35		
400	500	0	-33	41	41	25	25	40		
500	630	0	-38	48	48	29	29	50		
630	800	0	-45	56	56	34	34	60		
800	1 000	0	-60	75	75	45	45	75		

Uguale a ΔB_S e V_{BS} per anello interno dello stesso cuscinetto.
Identical to ΔB_S and V_{BS} of the inner ring of the relevant bearing.

* Valido prima dell'assemblaggio del cuscinetto e solo dopo aver smontato gli anelli elastici interni ed esterni
Applies before assembly of the bearing and after removed of internal and external snap rings

Tolleranze dei cuscinetti assiali - Axial bearings tolerances

Tolleranze del diametro foro delle ralle per albero (valori tolleranze in μm) Tolerances for bore diameter of shaft locating washer (tolerance values in μm)

d mm		Δd_{mp} scostamento / deviation		V_{dpm}
oltre over	fino a up to	max	min	max
-	18	0	-8	6
18	30	0	-10	8
30	50	0	-12	9
50	80	0	-15	11
80	120	0	-20	15
120	180	0	-25	19
180	250	0	-30	23
250	315	0	-35	26
315	400	0	-40	30
400	500	0	-45	34
500	630	0	-50	38
630	800	0	-75	-
800	1 000	0	-100	-
1 000	1 250	0	-125	-

Variazione dello spessore delle ralle per albero e per alloggiamento (valori tolleranze in μm) Thickness variation in shaft and housing washers (tolerance values in μm)

d mm		S_i Classe di tolleranza / Tolerance class			S_e Classe di tolleranza / Tolerance class
oltre over	fino a up to	P0 (tolleranze normali) P0 (normal tolerance) max	P6 max	P5 max	P0 (tolleranze normali) P6, P5 P0 (normal tolerance) P6, P5
-	18	10	5	3	
18	30	10	5	3	
30	50	10	6	3	
50	80	10	7	4	
80	120	15	8	4	
120	180	15	9	5	
180	250	20	10	5	
250	315	25	13	7	
315	400	30	15	7	
400	500	30	18	9	
500	630	35	21	11	
630	800	40	25	13	
800	1 000	45	30	15	
1 000	1 250	50	35	18	

Identico a S_i per la ralla per albero dello stesso cuscinetto.
Identical to S_i for the shaft washer of the relevant bearing.

Tolleranze del diametro esterno delle ralle per alloggiamento (valori tolleranze in μm) Tolerances for outside diameter of housing locatin washers (tolerance values in μm)

D mm		ΔD_{mp} scostamento / deviation		V_{Dp}
oltre over	fino a up to	max	min	max
10	18	0	-11	8
18	30	0	-13	10
30	50	0	-16	12
50	80	0	-19	14
80	120	0	-22	17
120	180	0	-25	19
180	250	0	-30	23
250	315	0	-35	26
315	400	0	-40	30
400	500	0	-45	34
500	630	0	-50	38
630	800	0	-75	55
800	1 000	0	-100	75
1 000	1 250	0	-125	-
1 250	1 600	0	-160	-

Tolleranze dell'altezza dei cuscinetti (valori tolleranze in μm) Tolerances of bearing height (tolerance values in μm)

d mm		T scostamento / deviation	
oltre over	fino a up to	max	min
-	30	+20	-250
30	50	+20	-250
50	80	+20	-300
80	120	+25	-300
120	180	+25	-400
180	250	+30	-400
250	315	+40	-400
315	400	+40	500
400	500	+50	-500
500	630	+60	-600
630	800	+70	-750
800	1 000	+80	-1 000
1 000	1 250	+100	-1 400



Tolleranze ISO per alberi (DIN ISO 286-2) - Shafts ISO clearance

Sigla Designation	Scostamento teorico Theoric Deviation	Campo dimensionale teorico in mm / Dimensional range mm																					
		plus de 3 plus de 6	6 10	10 18	18 30	30 40	40 50	50 65	65 80	80 100	100 120	120 140	140 160	160 180	180 200	200 225	225 250	250 280	280 315	315 355	355 400	400 450	450 500
		Scostamenti in µm / Deviation µm																					
a 12	sup. inf.	-270 -380	-280 -430	-290 -470	-300 -510	-310 -560	-320 -570	-340 -640	-360 -660	-380 -730	-410 -760	-460 -860	-520 -920	-580 -980	-660 -1120	-740 -1200	-820 -1280	-920 -1440	-1050 -1570	-1200 -1770	-1350 -1920	-1500 -2130	-1650 -2280
a 13	sup. inf.	-270 -450	-280 -500	-290 -560	-300 -630	-310 -700	-320 -710	-340 -800	-360 -820	-380 -920	-410 -950	-460 -1090	-520 -1150	-580 -1210	-660 -1380	-740 -1460	-820 -1540	-920 -1730	-1050 -1860	-1200 -2090	-1350 -2240	-1500 -2470	-1650 -2620
c 13	sup. inf.	-70 -250	-80 -300	-95 -365	-110 -440	-120 -510	-130 -520	-140 -600	-150 -610	-170 -710	-180 -720	-200 -830	-210 -840	-230 -860	-240 -960	-260 -980	-280 -1000	-300 -1110	-330 -1140	-360 -1250	-400 -1290	-440 -1410	-480 -1450
d 6	sup. inf.	-30 -38	-40 -49	-50 -61	-65 -78	-80 -96	-100 -119	-120 -142	-145 -170	-170 -199	-190 -222	-210 -246	-230 -270										
e 6	sup. inf.	-20 -28	-25 -34	-32 -43	-40 -53	-50 -66	-60 -79	-72 -94	-85 -110	-100 -129	-110 -142	-125 -161	-135 -175										
e 13	sup. inf.	-20 -200	-25 -245	-32 -302	-40 -370	-50 -440	-60 -520	-72 -612	-85 -715	-100 -820	-110 -920	-125 -1015	-135 -1105										
f 5	sup. inf.	-10 -15	-13 -19	-16 -24	-20 -29	-25 -36	-30 -43	-36 -51	-43 -61	-50 -70	-56 -79	-62 -87	-68 -95										
f 6	sup. inf.	-10 -18	-13 -22	-16 -27	-20 -33	-25 -41	-30 -49	-36 -58	-43 -68	-50 -79	-56 -88	-62 -98	-68 -108										
f 7	sup. inf.	-10 -22	-13 -28	-16 -34	-20 -41	-25 -50	-30 -60	-36 -71	-43 -83	-50 -96	-56 -108	-62 -119	-68 -131										
g 5	sup. inf.	-4 -9	-5 -11	-6 -14	-7 -16	-9 -20	-10 -23	-12 -27	-14 -32	-15 -35	-17 -40	-18 -43	-20 -47										
g 6	sup. inf.	-4 -12	-5 -14	-6 -17	-7 -20	-9 -25	-10 -29	-12 -34	-14 -39	-15 -44	-17 -49	-18 -54	-20 -60										
g 7	sup. inf.	-4 -16	-5 -20	-6 -24	-7 -28	-9 -34	-10 -40	-12 -47	-14 -54	-15 -61	-17 -69	-18 -75	-20 -83										
h 4	sup. inf.	0 -4	0 -4	0 -5	0 -6	0 -7	0 -8	0 -10	0 -12	0 -14	0 -16	0 -18	0 -20										
h 5	sup. inf.	0 -5	0 -6	0 -8	0 -9	0 -11	0 -13	0 -15	0 -18	0 -20	0 -23	0 -25	0 -27										
h 6	sup. inf.	0 -8	0 -9	0 -11	0 -13	0 -16	0 -19	0 -22	0 -25	0 -29	0 -32	0 -36	0 -40										
h 7	sup. inf.	0 -12	0 -15	0 -18	0 -21	0 -25	0 -30	0 -35	0 -40	0 -46	0 -52	0 -57	0 -63										
h 8	sup. inf.	0 -18	0 -22	0 -27	0 -33	0 -39	0 -46	0 -54	0 -63	0 -72	0 -81	0 -89	0 -97										
h 10	sup. inf.	0 -48	0 -58	0 -70	0 -84	0 -100	0 -120	0 -140	0 -160	0 -185	0 -210	0 -230	0 -250										
h 11	sup. inf.	0 -75	0 -90	0 -110	0 -130	0 -160	0 -190	0 -220	0 -250	0 -290	0 -320	0 -360	0 -400										
h 12	sup. inf.	0 -120	0 -150	0 -180	0 -210	0 -250	0 -300	0 -350	0 -400	0 -460	0 -520	0 -570	0 -630										
j 5	sup. inf.	+3 -2	+4 -2	+5 -3	+5 -4	+6 -5	+6 -7	+6 -9	+7 -11	+7 -13	+7 -16	+7 -18	+7 -20										
j 6	sup. inf.	+6 -2	+7 -2	+8 -3	+9 -4	+11 -5	+12 -7	+13 -9	+14 -11	+16 -13	+16 -16	+18 -18	+20 -20										
j 7	sup. inf.	+8 -4	+10 -5	+12 -6	+13 -8	+15 -10	+18 -12	+20 -15	+22 -18	+25 -21	+26 -26	+29 -28	+31 -32										
js 5	sup. inf.	+2,5 -2,5	+3 -3	+4 -4	+4,5 -4,5	+5,5 -5,5	+6,5 -6,5	+7,5 -7,5	+9 -9	+10 -10	+11,5 -11,5	+12,5 -12,5	+13,5 -13,5										
js 6	sup. inf.	+4 -4	+4,5 -4,5	+5,5 -5,5	+6,5 -6,5	+8 -8	+9,5 -9,5	+11 -11	+12,5 -12,5	+14,5 -14,5	+16 -16	+18 -18	+20 -20										
js 7	sup. inf.	+6 -6	+7,5 -7,5	+9 -9	+10,5 -10,5	+12,5 -12,5	+15 -15	+17,5 -17,5	+20 -20	+23 -23	+26 -26	+28,5 -28,5	+31,5 -31,5										
k 5	sup. inf.	+6 +1	+7 +1	+9 +1	+11 +2	+13 +2	+15 +2	+18 +3	+21 +3	+24 +4	+27 +4	+29 +4	+32 +5										
k 6	sup. inf.	+9 +1	+10 +1	+12 +1	+15 +2	+18 +2	+21 +2	+25 +3	+28 +3	+33 +4	+36 +4	+40 +4	+45 +5										
k 7	sup. inf.	+13 +1	+16 +1	+19 +1	+23 +2	+27 +2	+32 +2	+38 +3	+43 +3	+50 +4	+56 +4	+61 +4	+68 +5										
m 5	sup. inf.	+9 +4	+12 +6	+15 +7	+17 +8	+20 +9	+24 +11	+28 +13	+33 +15	+37 +17	+43 +20	+46 +21	+50 +23										
m 6	sup. inf.	+12 +4	+15 +6	+18 +7	+21 +8	+25 +9	+30 +11	+35 +13	+40 +15	+46 +17	+52 +20	+57 +21	+63 +23										
m 7	sup. inf.	+16 +4	+21 +6	+25 +7	+29 +8	+34 +9	+41 +11	+48 +13	+55 +15	+63 +17	+72 +20	+78 +21	+86 +23										
n 5	sup. inf.	+13 +8	+16 +10	+20 +12	+24 +15	+28 +17	+33 +20	+38 +23	+45 +27	+51 +31	+57 +34	+62 +37	+67 +40										
n 6	sup. inf.	+16 +8	+19 +10	+23 +12	+28 +15	+33 +17	+39 +20	+45 +23	+52 +27	+60 +31	+66 +34	+73 +37	+80 +40										
n 7	sup. inf.	+20 +8	+25 +10	+30 +12	+36 +15	+42 +17	+50 +20	+58 +23	+67 +27	+77 +31	+86 +34	+94 +37	+103 +40										
p 5	sup. inf.	+17 +12	+21 +15	+26 +18	+31 +22	+37 +26	+45 +32	+52 +37	+61 +43	+70 +50	+79 +56	+87 +62	+95 +68										
p 6	sup. inf.	+20 +12	+24 +15	+29 +18	+35 +22	+42 +26	+51 +32	+59 +37	+68 +43	+79 +50	+88 +56	+98 +62	+108 +68										
r 6	sup. inf.	+23 +15	+28 +19	+34 +23	+41 +28	+50 +34	+60 +41	+62 +43	+57 +51	+76 +54	+88 +63	+90 +65	+93 +68	+106 +77	+109 +80	+113 +84	+126 +94	+130 +98	+144 +108	+150 +114	+166 +126	+172 +132	

11

GIUOCO RADIALE DEI CUSCINETTI A RULLINI

RADIAL CLEARANCE OF NEEDLE ROLLER BEARINGS

Uno dei principali fattori di influenza sulla durata dei cuscinetti a rullini è il giuoco radiale, determinato come il valore medio di varie misure dello spostamento totale sul piano perpendicolare all'asse del cuscinetto. Tale spostamento è tipico di uno degli anelli del cuscinetto (l'altro è stazionario) durante il rotolamento in varie direzioni angolari, sia rispetto all'anello rotante che a quello stazionario e a diverse posizioni angolari della serie di sfere o rulli rispetto agli anelli stessi.

Visti i diversi coefficienti di giuoco richiesti alla consegna, i cuscinetti radiali vengono costruiti secondo vari gruppi di giuoco iniziale. Di norma, i cuscinetti radiali a rullini vengono costruiti secondo il gruppo a giuoco radiale normale CN, che, ad impieghi comuni alla maggior parte dei casi, forniscono parametri soddisfacenti di funzionamento. Il giuoco radiale viene evidenziato con l'aggiunta alla sigla del cuscinetto della designazione della classe di precisione (C2, C3, C4, C5), mentre ai cuscinetti costruiti con un giuoco radiale corrispondente al gruppo normale non vengono assegnate ulteriori designazioni convenzionali. Le tabelle seguenti forniscono i valori di giuoco radiale.

One of the most important factor influencing the life of a needle roller bearing, is the radial clearance.

This is determined by a mean of several measurements of total displacement in the plane perpendicular to the bearing axle.

This displacement is typical for one of the bearing ring (the other is stationary) during its rotation in different angular directions, both with respect to the rotatable ring and the stationary one, and a different angular position of the set of balls or rollers, with respect to the bearing races.

Because of the different requirements concerning the radial clearance, bearings are manufactured with several initial clearance groups, such as additional groups.

Radial bearings are usually manufactured in accordance with the normal clearance group CN: this enables a satisfactory functioning of the bearing, in the majority of cases.

Radial clearance is pointed out by adding the precision class (C2, C3, C4, C5) to bearing group.

No further conventional designation are assigned to normal clearance bearings.

Values of radial clearances are given below, see tables.

Tipologia di giuoco radiale dei cuscinetti

Types of radial clearance

GIUOCO CLEARANCE	SIGNIFICATO MEANING
C2	Giuoco radiale dei cuscinetti inferiore a CN Radial clearance of bearings lower than CN
CN	Giuoco radiale dei cuscinetti normale Normal radial clearance of bearings
C3	Giuoco radiale dei cuscinetti superiore a CN Radial clearance of bearings higher than CN
C4	Giuoco radiale dei cuscinetti superiore a C3 Radial clearance of bearings higher than C3

Giuoco radiale dei cuscinetti a rullini ed a rulli cilindrici

Radial clearance of needle roller and cylindrical roller bearings

Diametro fori (mm) Bore diameter (mm)		Giuoco radiale (µm) - Radial clearance (µm)							
		C2		CN		C3		C4	
da from	a to	min.	max.	min.	max.	min.	max.	min.	max.
-	24	0	25	20	45	35	60	50	75
24	30	0	25	20	45	35	60	50	75
30	40	5	30	25	50	45	70	60	85
40	50	5	35	30	60	50	80	70	100
50	65	10	40	40	70	60	90	80	110
65	80	10	45	40	75	65	100	90	125
80	100	15	50	50	85	75	110	105	140
100	120	15	55	50	90	85	125	125	165
120	140	15	60	60	105	100	145	145	190
140	160	20	70	70	120	115	165	165	215
160	180	25	75	75	125	120	170	170	220
180	200	35	90	90	145	140	195	195	250
200	225	45	105	105	165	160	220	220	280
225	250	45	110	110	175	170	235	235	300
250	280	55	125	125	195	190	260	260	330
280	315	55	130	130	205	200	275	275	350
315	355	65	145	145	225	225	305	305	385
355	400	100	190	190	280	280	370	370	460
400	450	110	210	210	310	310	410	410	510
450	500	100	220	220	330	330	440	440	550

12

MONTAGGIO E SMONTAGGIO

MOUNTING AND DISMOUNTING

Le sedi di montaggio dei cuscinetti devono sempre essere perfettamente pulite, in quanto le impurità possono essere causa di mal funzionamento del cuscinetto. Al momento del montaggio devono essere controllate le tolleranze dimensionali, per ciò che riguarda il foro dell'alloggiamento e la sede dell'albero. Per un corretto montaggio è opportuno utilizzare apposita attrezzatura, ma si può procedere anche senza, purchè non si comprometta il buon funzionamento del pezzo. Il montaggio può essere agevolato attraverso l'utilizzo di una buona lubrificazione sia degli anelli interni che esterni e delle sedi di alloggiamento.

Si raccomanda inoltre di eseguire il montaggio sempre dopo aver portato il cuscinetto a temperatura di circa 80°, in forno od a bagno d'olio ed effettuare una prova di funzionamento del cuscinetto.

Per ciò che riguarda lo smontaggio del cuscinetto dovrebbe essere prevista già in fase di progettazione la possibilità di utilizzare un estrattore. Dopo lo smontaggio è necessario ripulire il cuscinetto con detergenti organici (petrolio privo di acidi ed acqua, oppure benzina) per poterlo riutilizzare.

The installation tool must always be clean, as impurity can compromise the good functioning of the bearing.

Before mounting, dimensional tolerances of housing bore and shaft have to be checked up.

To realise a good mounting, an appropriate equipment must be used, in some cases it is possible to proceed without it on condition that good working won't be compromised.

A good lubrication of inner and outer rings as long as housing, can facilitate mounting operations; we recommend to carry out assembling operations only after bringing the bearing to an 80° temperature, in a kiln or with a bath oil, and only after making a trial working test of the bearing.

Concerning dismounting, the possibility of using a puller should have already been studied during the design.

After dismounting it is necessary to wash the bearing with organic cleaners (oil without acids and water, or petrol), before using it again.

13

NOTE GENERALI

GENERAL NOTES

Si raccomanda di conservare i cuscinetti a rullini ISB in ambienti asciutti, con temperature possibilmente costanti ed un grado di umidità massima del 65/70%.

We recommend to store ISB needle bearings in a dry place, possibly with constant temperatures and with a maximum humidity of 65/70%.

14

CONFEZIONI ED IMBALLI

PACKINGS

Tutti i cuscinetti a rullini ISB potranno essere forniti in confezioni di diversa tipologia; singolarmente oppure in confezioni ad uso industriale cioè sciolti e protetti da fogli di nylon o tubetti in plastica. La scatole esterne sono di robusto cartone e vengono solitamente accatastate su pallets regettati, o inserite in grosse casse di legno, o robusto cartone fissato su pallets.

All ISB needle roller bearings can be supplied with different kind of boxes: single or industrial packed, these latter can be rolled in cellophane or contained in plastic tubes.

Boxes are made of strong cardboard piled up on bound pallets or included in wooden cases to get transport operations easier.













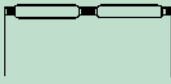



15







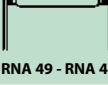
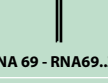



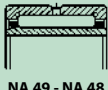



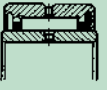



SIMBOLI ED UNITÀ DI MISURA



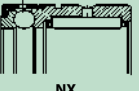
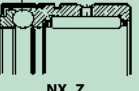



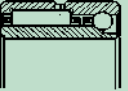
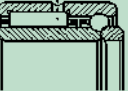

















TOLERANCE SYMBOLS AND DEFINITIONS







d	diametro nominale del foro
V_{dp}	variazione del diametro del foro
V_{dmp}	variazione del diametro medio del foro
Δ_{dmp}	scostamento del diametro medio del foro dal valore nominale
D	diametro nominale esterno
V_{Dp}	variazione del diametro esterno
V_{Dmp}	variazione del diametro esterno medio
Δ_{Dmp}	scostamento del diametro esterno medio dal valore nominale
K_{ia} - K_{ea}	concentricità di rotazione dell'anello interno (K _{ia}) o esterno (K _{ea}) nel cuscinetto assemblato
B	larghezza del cuscinetto
Δ_{Bs} - Δ_{Cs}	scostamento di una singola misura della larghezza dell'anello interno (Δ _{Bs}) o esterno (Δ _{Cs}) rispetto alla dimensione nominale
V_{Bs} - V_{Cs}	variazione della larghezza dell'anello interno (V _{Bs}) ed esterno (V _{Cs})
S_d	difetto di quadratura delle facciate rispetto al foro (planarità)
S_D	variazione dell'inclinazione della superficie cilindrica esterna rispetto alla superficie laterale
S_i	variazione dello spessore di una ralla per albero
S_e	variazione dello spessore di una ralla per alloggiamento
T	valore nominale dell'altezza di un cuscinetto assiale a semplice effetto

d	<i>nominal bore diameter</i>
V_{dp}	<i>bore diameter variation</i>
V_{dmp}	<i>mean bore diameter variation</i>
Δ_{dmp}	<i>deviation of the mean inner diameter from nominal value</i>
D	<i>nominal outer diameter</i>
V_{Dp}	<i>outer diameter variation</i>
V_{Dmp}	<i>mean outer diameter variation</i>
Δ_{Dmp}	<i>deviation of the mean outer diameter from nominal value</i>
K_{ia} - K_{ea}	<i>concentricity radial run out of inner (K_{ia}) and outer (K_{ea}) ring of assembled bearing</i>
B	<i>bearing width</i>
Δ_{Bs} - Δ_{Cs}	<i>inner (Δ_{Bs}) and outer ring (Δ_{Cs}) single width deviation as regards to nominal dimension</i>
V_{Bs} - V_{Cs}	<i>width variation of inner (V_{Bs}) and outer (V_{Cs}) ring</i>
S_d	<i>side face run out with reference to bore of the inner ring (run out)</i>
S_D	<i>variation in inclination of outside cylindrical surface to outer ring side face</i>
S_i	<i>thickness variation of shaft locating washer</i>
S_e	<i>thickness variation of housing locating washer</i>
T	<i>nominal bearing width of a single direction axial bearing</i>

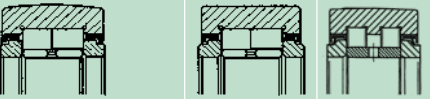
Disegno Drawing		Sigla Designation	Dimensioni Dimensions	Pagina Page
		Gabbie a rullini singola e doppia corona (serie K - K..ZW) <i>Needle roller and cage assemblies single/double crown (K - K..ZW series)</i>	3-265	28-36
		Gabbie a rullini per imbiellaggi, supporto bottone di manovella (serie KZK) <i>Needle roller and cage assemblies for crank pin of connecting rod (KZK series)</i>	8-40	40-41
		Gabbie a rullini per imbiellaggi, per supporto spinotto (serie KBK) <i>Needle roller and cage assemblies for piston pin of connecting rod (KBK series)</i>	8-20	42-43
		Gabbie lineari piane a rullini (serie GLP) <i>Needle roller flat cage (GLP series)</i>	20-40	48
		Astucci a rullini aperti (serie HK) <i>Drawn cup needle roller bearings open end (HK series)</i>	3-60	52-53
		Astucci a rullini con fondello (serie BK) <i>Drawn cup needle roller bearings closed end (BK series)</i>	3-60	52-53
		Astucci a rullini con anelli di tenuta (serie HK..RS..2RS) <i>Sealed drawn cup needle roller bearings (HK..RS..2RS series)</i>	8-50	54
		Astucci a rullini con fondello ed anelli di tenuta (serie BK..RS) <i>Sealed drawn cup needle roller bearings closed end (BK..RS series)</i>	14-25	54
		Astucci a rullini a pieno riempimento (serie HN) <i>Drawn cup needle roller bearings full complement (HN series)</i>	10-50	55
		Cuscinetti a rullini senza anello interno (serie leggera NK) <i>Needle roller bearings without inner ring (NK light series)</i>	5-155	60-64
		Cuscinetti a rullini senza anello interno (serie pesante NKS) <i>Needle roller bearings without inner ring (NKS heavy series)</i>	8-115	60-64
		Cuscinetti a rullini senza anello interno (serie RNA 49-RNA 48) <i>Needle roller bearings without inner ring (RNA 49 - RNA 48 series)</i>	14-415	60-64
		Cuscinetti a rullini senza anello interno - a una o due corone (serie RNA 69 - RNA 69..ZW) <i>Needle roller bearings without inner ring - double row (RNA 69 series)</i>	14-110	60-64
		Cuscinetti a rullini con anello interno (serie leggera NKI) <i>Needle roller bearings with inner ring (NKI light series)</i>	5-100	65-68

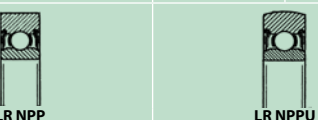
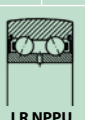
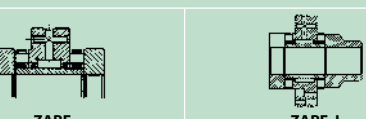
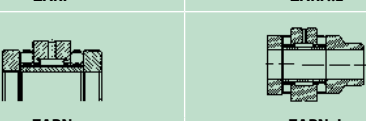
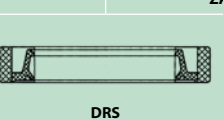
Disegno Drawing	Sigla Designation	Dimensioni Dimensions	Pagina Page
 NKIS	Cuscinetti a rullini con anello interno (serie pesante NKIS) <i>Needle roller bearings with inner ring (NKIS heavy series)</i>	8-100	65-68
 NA 49 - NA 48	Cuscinetti a rullini con anello interno (serie NA 49 - NA 48) <i>Needle roller bearings with inner ring (NA 49 - NA 48 series)</i>	10-380	65-68
 NA 69 - NA 69..ZW	Cuscinetti a rullini con anello interno - a una o a due corone (serie NA 69 - NA69.ZW) <i>Needle roller bearings with inner ring - double row (NA 69 series)</i>	10-95	65-68
 RNA 49 RS	Cuscinetti a rullini con anelli di tenuta senza anello interno (serie RNA 49 RS - RNA 49 2RS) <i>Sealed needle roller bearings without inner ring (RNA 49 RS - RNA 49 2RS series)</i>	14-58	69
 RNA 49 2RS			
 NA 49 RS	Cuscinetti a rullini con anelli di tenuta ed anello interno (serie NA 49 RS - NA 49 2RS) <i>Sealed needle roller bearings with inner ring (NA 49 RS - NA 49 2RS series)</i>	10-50	69
 NA 49 2RS			
 RNAO	Cuscinetti a rullini senza bordi e senza anello interno - singola e doppia corona (serie RNAO) <i>Needle roller bearings without ribs and inner ring - single/double row (RNAO series)</i>	5-100	74-75
 RNAO..ZW			
 NAO	Cuscinetti a rullini senza bordi con anello interno - singola e doppia corona (serie NAO) <i>Needle roller bearings without ribs and with inner ring - single/double row (NAO series)</i>	6-90	76
 NAO..ZW			
 RPNA	Cuscinetti orientabili a rullini senza e con anello interno (serie RPNA-PNA) <i>Aligning needle roller bearings with/without inner ring (RPNA-PNA series)</i>	15-45 12-40	80
 PNA			
 NX	Cuscinetti combinati radiali a rullini ed assiali a sfere a pieno riempimento di sfere (serie NX - NX..Z) <i>Combined needle roller axial ball bearings full complement (NX - NX..Z series)</i>	7-35	84
 NX..Z			
 NKX	Cuscinetti combinati radiali a rullini ed assiali a sfere (serie NKX - NKX..Z) <i>Needle roller axial ball bearings (NKX - NKX..Z series)</i>	10-70	85
 NKX..Z			
 NKXR	Cuscinetti combinati a rullini ed assiali a rulli cilindrici (serie NKXR - NKXR..Z) <i>Needle roller axial cylindrical roller bearings (NKXR - NKXR..Z series)</i>	15-50	86
 NKXR..Z			
 NKIA	Cuscinetti combinati a rullini ed obliqui a sfera monodirezionale (serie NKIA) <i>Needle roller angular contact ball bearings single direction (NKIA series)</i>	12-70	87
 NKIB	Cuscinetti combinati a rullini ed obliqui a sfera bidirezionali (serie NKIB) <i>Needle roller angular contact ball bearings double direction (NKIB series)</i>	12-70	87
 IR - LR	Anelli interni (serie IR - LR) <i>Inner rings (IR - LR series)</i>	5-380	92-94

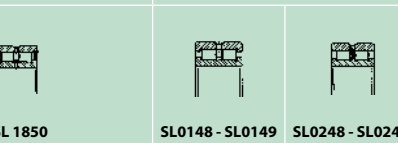
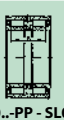
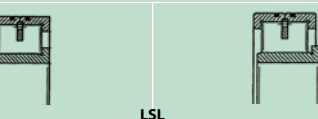
Disegno Drawing		Sigla Designation	Dimensioni Dimensions	Pagina Page
 HF - HF..KF - HF..R - HF..KFR		Ruote libere ad astuccio (serie HF) <i>Drawn cup roller clutches (HF series)</i>	3-35	98
 HFL - HFL..KF - HFL..R - HFL..KFR		Ruote libere ad astuccio con supporti (serie HFL) <i>Drawn cup roller clutches with bearings assemblies (HFL series)</i>	3-35	99
 811-812	 893	Cuscinetti assiali a rulli cilindrici (serie 811 - 812 - 893 - 894) <i>Axial cylindrical roller bearings (811 - 812 - 893 - 874 - 894 series)</i>	15-360	106-113
 894			30-360 30-150 60-320	
 K 811-812	 K 893	Gabbie assiali a rulli cilindrici (serie K 811 - K 812 - K 893 - K 894) <i>Axial cylindrical roller and cage assembly (K 811 - K 812 - K 893 - K 894 series)</i>	15-360	106-113
 K 894			30-360 30-150 60-320	
 GS 811 - 812 - 893 - 894		Ralle per alloggiamento (serie GS 811 - GS 812 - GS 893 - GS 894) <i>Housing locating washers (GS 811 - GS 812 - GS 893 - GS 894 series)</i>	15-360 30-360 30-150 60-320	106-113
 WS 811 - 812 - 893 - 894		Ralle per albero (serie WS 811 - WS 812 - WS 893 - WS 894) <i>Shaft locating washers (WS 811 - WS 812 - WS 893 - WS 894 series)</i>	15-360 30-360 30-150 60-320	106-113
 LS		Ralle di rotolamento (serie LS) <i>Bearing washers (LS series)</i>	15-160	106-113
 AXK	 AS	Gabbie assiali a rullini (serie AXK) e ralle (serie AS) <i>Axial needle roller and cage assemblies (AXK series) and washers (AS serie)</i>	4-160	114
 AXW		Cuscinetti assiali a rullini con bordo di centraggio nella ralla assiale (serie AXW) <i>Axial needle roller bearings with centring spigot on the bearing washer (AXW series)</i>	10-50	115
 ZSI - ZSE		Ralle intermedie con centraggio interno ed esterno (serie ZSI - ZSE) <i>Intermediate washers with inner/outer centering (ZSI - ZSE series)</i>	15-160	116-117
 RSTO	 RSTO..X	Rotelle a rulli senza guida assiale senza e con anello interno (serie RSTO - RSTO..X - STO - STO..X) <i>Yoke type track rollers without axial guidance with/without inner ring (RSTO - RSTO..X - STO - STO..X series)</i>	16-90	122
 STO	 STO..X			
 RNA22..2RS	 RNA22..2RSX	Rotelle a rulli senza guida assiale con tenute (serie RNA22..2RS - RNA22..2RSX - NA22..2RS - NA22..2RSX) <i>Sealed yoke type track rollers without axial guidance (RNA22..2RS - RNA22..2RSX - NA22..2RS - NA22..2RSX series)</i>	19-90	123
 NA22..2RS	 NA22..2RSX			
 NATR		Rotelle a rulli con guida assiale (serie NATR - NATR..PP) <i>Yoke type track rollers with axial guidance (NATR - NATR..PP series)</i>	16-90	124
 NATV		Rotelle a rulli con guida assiale - pieno riempimento di rullini (serie NATV - NATV..PP) <i>Yoke type track roller with axial guidance - full complement of needle rollers (NATV - NATV..PP series)</i>	16-90	124

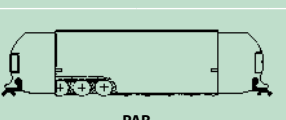
Disegno Drawing	Sigla Designation	Dimensioni Dimensions	Pagina Page
 <p style="text-align: center;">NNTR</p>	Rotelle a rulli con guida assiale a pieno riempimento di rulli schermati (serie NNTR) <i>Yoke type track rollers with axial guidance, full complement cylindrical roller set, sealed on both sides (NNTR series)</i>	130-310	125
 <p style="text-align: center;">NUTR NUTR..X PWTR..2RS</p>	Rotelle a rulli con guida assiale, anello interno, pieno riempimento di rulli e tenute (serie NUTR - NUTR..X - PWTR..2RS) <i>Yoke type track rollers with axial guidance, inner ring, full complement of rollers and seals (NUTR - NUTR..X - PWTR..2RS series)</i>	35-110	126
 <p style="text-align: center;">KR - KR..PP NUKR PWKR..2RS</p>	Perni folli (serie KR - KR..PP - KRV - KRV..PP - NUKR - PWKR - KRE - KRE..PP - KRVE - KRVE..PP - NUKRE - PWKRE) <i>Stud type track roller (KR - KR..PP - KRV - KRV..PP - NUKR - PWKR - KRE - KRE..PP - KRVE - KRVE..PP - NUKRE - PWKRE series)</i>	16-90	130-135
 <p style="text-align: center;">LR NPP LR NPPU</p>	Rotelle ad una corona di sfere (serie LR NPP- LR NPPU) <i>Wheels with single row balls (LR NPP - LR NPPU series)</i>	10-45 4-20	140
 <p style="text-align: center;">LR NPPU</p>	Rotelle a due corone di sfere <i>Wheels with double rows balls</i>	5-40	141-142
 <p style="text-align: center;">ZARF ZARF..L</p>	Cuscinetti combinati, a rullini ed assiali a rulli cilindrici (serie ZARF - ZARF..L) <i>Needle roller axial cylindrical roller bearings (ZARF - ZARF..L series)</i>	15-50	146-147
 <p style="text-align: center;">ZARN ZARN..L</p>	Cuscinetti combinati, a rullini ed assiali a rulli cilindrici (serie ZARN - ZARN..L) <i>Needle roller axial cylindrical roller bearings (ZARN - ZARN..L series)</i>	15-50	148-149
 <p style="text-align: center;">DRS</p>	Porta tenute (serie DRS) <i>Seal carrier assembly DRS series (DRS series)</i>	15-90	150
 <p style="text-align: center;">SL 1818 - SL1829 - SL 1830 - SL 1822 SL 1923</p>	Cuscinetti radiali a rulli cilindrici a pieno riempimento, ad una corona. Cuscinetti di appoggio <i>Cylindrical roller bearings, full complement roller set, single row. Semi-locating bearings</i>	200-500 60-500 20-400 20-200 25-120	154-157
 <p style="text-align: center;">SL 1850 SL0148 - SL0149 SL0248 - SL0249</p>	Cuscinetti radiali a rulli cilindrici a pieno riempimento, a due corone. Cuscinetti di appoggio, cuscinetti bloccati, cuscinetti liberi <i>Cylindrical roller bearings, full complement roller set, double row. Semi-locating bearings, non locating bearings</i>	20-150 150-400 60-400 150-400 60-400	158-161
 <p style="text-align: center;">SL04050..PP - SL04..PP</p>	Cuscinetti a rulli cilindrici con gole per anelli elastici a pieno riempimento, schermati, cuscinetti bloccati <i>Cylindrical roller bearings with snap ring grooves full complement roller set, locating bearings</i>	20-300 130-300	162-165
 <p style="text-align: center;">LSL</p>	Cuscinetti radiali a rulli cilindrici con gabbia a disco ²⁾, cuscinetti di appoggio <i>Cylindrical roller bearings with disc cage ²⁾, semi-locating bearings</i>	80-300	166
 <p style="text-align: center;">ZLS</p>	Cuscinetti radiali a rulli cilindrici con distanziali ²⁾, cuscinetti di appoggio <i>Cylindrical roller bearings with spacers ²⁾, semi-locating bearings</i>	25-120	167
 <p style="text-align: center;">PAR</p>	Pattini a rulli (serie PAR) <i>Recirculating linear roller bearings (PAR series)</i>	19-85	172

Disegno Drawing	Sigla Designation	Dimensioni Dimensions	Pagina Page
NR FORMA A - A FORM FORMA B - B FORM	Rullini (serie NR) <i>Needle rollers (NR series)</i>	1-6	176
 VB	Anelli di tenuta per bussole di scorrimento (serie VB) <i>Seals for sliding ball bushing (VB series)</i>	4-136,50	180-181
 VC	Anelli di tenuta per bussole di scorrimento (serie VC) <i>Seals for sliding ball bushing (VC series)</i>	3,18-96	182-183
 VCW	Anelli di tenuta per bussole di scorrimento (serie VCW) <i>Seals for sliding ball bushing (VCW series)</i>	7-70	184
 SD	Anelli di tenuta a due labbri (serie SD) <i>Bearings rings double lip (SD series)</i>	8-50	185
 AF	Anelli elastici per fori (serie AF) <i>Elastic rings for bores (AF series)</i>	7-440	192-193
 AE	Anelli elastici per alberi esecuzione normale (serie AE) <i>Elastic rings for shafts normal execution (AE series)</i>	4-460	194-195
 AES	Anelli elastici per alberi esecuzione rinforzata (serie AES) <i>Elastic rings for shafts reinforced execution (AES series)</i>	42-460	196
 Manicotti a sfere <i>Slide bushes</i>			208-221
 Supporti in lega di alluminio <i>Aluminium linear case units</i>			223-227

Prodotti customizzati Customized products

Perni folli <i>Stud type track rollers</i>	tipo FR 22 EI	
	tipo FRR 22 EI	
	tipo FR 32 EI	
	tipo FRR 32 EI	
	tipo FR 40 EI	
	tipo FRR 40 EI	
	tipo FRN 32 EI	
	tipo FRN 40 EI	
	tipo FRNR 40 EI	
Cuscinetti combinati a rullini <i>Combined needle roller bearings</i>	tipo RAX 435	
	tipo RAX 445	
	tipo RAX 730	
	tipo RAX 740	



GABBIE A RULLINI

NEEDLE ROLLER AND CAGE ASSEMBLIES





Le gabbie a rullini ISB costituiscono una parte dei cuscinetti volventi. Sono principalmente formate da due elementi, una gabbia e vari rullini. La caratteristica principale delle gabbie a rullini è di poter realizzare delle applicazioni con elevata capacità di carico ed un ingombro minimo, in quanto ogni singolo rullino viene guidato singolarmente all'interno della gabbia, ottenendo così una maggiore precisione e di conseguenza la possibilità di numeri di giri maggiori, a differenza dei cuscinetti. La gabbia può essere in acciaio, in plastica (sigla TN) solitamente per piccoli diametri, mentre per diametri maggiori è in ottone. La gabbia a rullini K può essere semplice ed a doppia corona, in tal caso sarà denominata K..ZW.

Precisione

Le gabbie a rullini K dispongono di rullini della classe di qualità G2 secondo DIN, ogni gabbia viene dotata di rullini della stessa classe. La classe dei rullini viene indicata sulla confezione. Quando si utilizzano gabbie a rullini con classe standard, solitamente si soddisfano esigenze per applicazioni normali, per casi particolari dove si vuole ottenere un giuoco d'esercizio diverso occorrerà scegliere la classe dei rullini più adatta per quell'applicazione.

Montaggio accoppiato

Quando sia ha la necessità di montare più gabbie a rullini ISB affiancate tra di loro, occorrerà tenere presente che se si vuole distribuire il carico in maniera equa ed uniforme sarà indispensabile montare gabbie a rullini che presentano le medesime caratteristiche sia dimensionali sia per ciò che riguarda la selezione dei rullini, onde evitare il sovraccarico su un elemento piuttosto che su un'altro.

Giuoco radiale

Il giuoco radiale viene determinato dalle tolleranze delle piste di rotolamento che sono ricavate sugli alberi e negli alloggiamenti oltre al gruppo di selezione d'appartenenza dei rullini. Le piste ricavate sugli alberi e negli alloggiamenti devono avere una durezza espressa in HRC da 58 a 64, in quanto una durezza inferiore potrebbe ridurre la capacità di carico.

Lubrificazione

Le gabbie a rullini possono essere lubrificate sia con grasso che con olio, naturalmente occorrerà tenere presente sempre le diverse condizioni d'utilizzo. La lubrificazione a grasso offre il vantaggio di un trattenimento maggiore del lubrificante stesso, oltre che a proteggere la gabbia dall'umidità ma sicuramente non permette di raggiungere le velocità che al contrario si possono ottenere con una lubrificazione ad olio. Di contro lubrificando una gabbia a rullini con olio di possono ottenere sicuramente velocità d'esercizio maggiori, ma sicuramente ci sarà una maggiore dispersione del lubrificante ed una minore protezione da eventuali fattori esterni (polvere, umidità, freddo ecc).

ISB needle roller and cage assemblies belong to roller bearings; they are formed by two elements: a cage and several rollers. Their most important characteristic is a great ability to stand very heavy loads and a reduced dimension, as every single roller is guided on its cage pocket. In this way a greater precision and a greater number of revolutions is obtained: this is the first difference from roller bearings.

For small diameters needle roller and cage assemblies are usually made of steel or plastic (TN ref.), whereas for bigger diameters brass is normally used.

K needle roller and cage assemblies can be single or double row, formally known as K..ZW.

Precision

K needle roller and cage assemblies are supplied with G2 quality class rollers according to DIN, and every cage is filled with the same class of rollers.

Class of quality is marked on every box.

When needle roller and cage assemblies belong to a standard class, their applications are normal; for special cases when clearance has to be different, a more favorable class of rollers must be chosen.

Mounting in sets

ISB needle roller and cage assemblies can be mounted side by side: to ensure an uniform load distribution is indispensable to have needle rollers of identical group, concerning both dimensions and selection of rollers.

Radial clearance

The radial clearance is determined by belonging roller selected group and by tolerances of raceways which are obtained on shafts or on housings.

Shaft raceways and housing raceways hardness must be in HRC from 58 to 64, seen that a lower hardness can reduce load ability.

Lubrication

ISB needle roller and cage assemblies can be oil or grease lubricated, this depends on the conditions of utilization.

A grease lubrication protects the cage from humidity and has a greater ability to keep the heat; furthermore it avoids leak of lubricant.

On the other hand it prevents from reaching high speeds that can be obtained from oil lubrication.

With an oil lubrication higher speeds can be reached but greater leak of lubricant and smaller protection from external factors such as dust, cool, humidity ... are present.

Tipologie delle gabbie a rullini - Needle roller and cage assembly types

Tipologia	Caratteristiche-Characteristics
K	Singola corona - Single row
K..ZW	Doppia corona - Double row

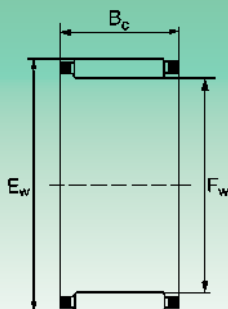
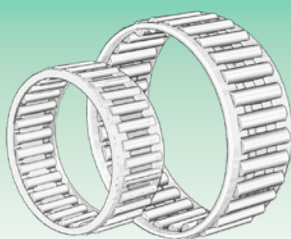

K
(singola corona - single row)

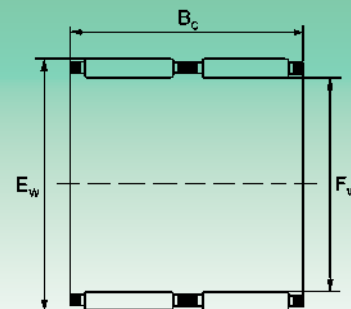
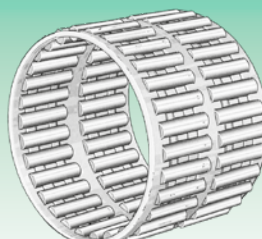

K..ZW
(doppia corona - double row)

Diametro albero (mm) Shaft diameter (mm)	Sigla Designation	Peso (g) Weight (g)	Dimensioni (mm) Dimensions (mm)			Coefficienti di carico (N) Basic load rating (N)		Velocità limite Limiting Speed
			F _w	E _w	B _c	Dinamico C Dynamic C	Statico C ₀ Static C ₀	Olio (N. giri max) Oil (max rpm)
3	K 3x5x7 TN	0.3	3	5	7	1 500	1 200	47 500
	K 3x5x9 TN	0.4	3	5	9	1 680	1 400	45 000
	• K 3x6x7 TN	0.4	3	6	7	1 400	920	44 650
4	K 4x7x7 TN	0.5	4	7	7	1 700	1 200	40 850
	• K 4x7x10 TN	0.7	4	7	10	2 280	1 850	40 850
5	K 5x8x8 TN	0.7	5	8	8	2 300	1 880	37 000
	K 5x8x10 TN	0.9	5	8	10	2 850	2 500	37 000
6	K 6x9x8 TN	0.8	6	9	8	2 560	2 240	35 150
	K 6x9x10 TN	1	6	9	10	3 300	3 100	35 150
	K 6x10x13 TN	1.3	6	10	13	3 800	2 900	33 250
7	K 7x9x7 TN	0.6	7	9	7	1 750	1 850	33 250
	K 7x10x8 TN	0.9	7	10	8	2 750	2 550	32 300
	K 7x10x10 TN	1.1	7	10	10	3 450	3 400	32 300
8	K 8x11x8 TN	1.1	8	11	8	3 000	2 900	30 400
	K 8x11x10 TN	1.7	8	11	10	3 830	3 950	30 400
	K 8x11x13 TN	1.8	8	11	13	5 000	5 700	30 400
	K 8x12x10 TN	2	8	12	10	4 900	4 600	30 400
9	K 9x12x10 TN	1.5	9	12	10	4 200	4 700	29 450
	K 9x12x13 TN	1.9	9	12	13	5 500	6 700	29 450
10	K 10x13x10 TN	1.6	10	13	10	4 500	5 250	27 550
	K 10x13x13 TN	2.1	10	13	13	6 000	7 600	27 550
	K 10x13x16 TN	2.2	10	13	16	6 750	8 800	27 550
	K 10x14x10 TN	2.9	10	14	10	7 000	7 900	27 550
	K 10x14x13 TN	4.3	10	14	13	7 500	8 400	27 550
	K 10x16x12 TN	5.5	10	16	12	8 100	7 200	26 600
12	• K 12x15x9 TN	2.7	12	15	9	4 120	5 210	26 000
	K 12x15x10 TN	1.9	12	15	10	4 650	5 800	25 650
	K 12x15x13 TN	2.4	12	15	13	6 000	8 100	25 650
	K 12x15x20 - ZW	5	12	15	20	8 200	12 000	24 700
	K 12x16x8 TN	2.9	12	16	8	6 000	6 900	25 650
	K 12x16x10 TN	3.8	12	16	10	7 900	9 200	25 650
	K 12x16x13 TN	5.5	12	16	13	9 300	10 000	24 700
	K 12x17x13 TN	4.4	12	17	13	9 800	9 405	24 700
14	K 12x18x12 TN	5	12	18	12	4 200	4 700	25 650
	K 14x17x10	4	14	17	10	5 100	6 800	23 750
	K 14x17x17 TN	6.8	14	17	17	9 300	14 000	23 750
	K 14x18x10	4.8	14	18	10	6 800	8 300	23 750
	K 14x18x13	6.3	14	18	13	8 100	9 800	23 750
	K 14x18x14	6.8	14	18	14	9 200	12 000	23 750
	K 14x18x15	7.3	14	18	15	10 000	13 000	23 750

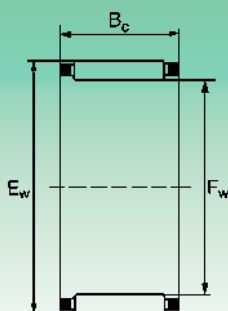
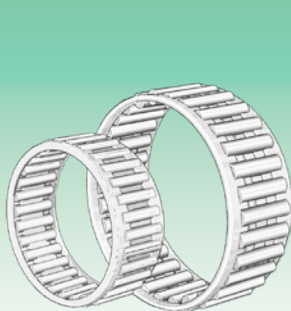
Gabbie a rullini singola e doppia corona (serie K • K..ZW)
Needle roller and cage assemblies single/double row (K • K..ZW series)

K
(singola corona - single row)

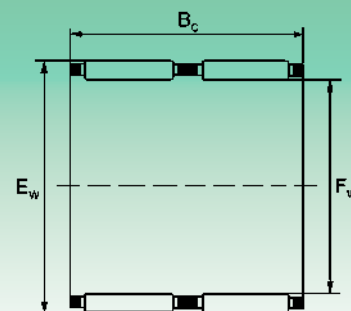
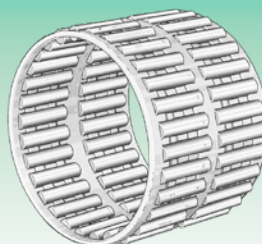

K..ZW
(doppia corona - double row)

Diametro albero (mm) Shaft diameter (mm)	Sigla Designation	Peso (g) Weight (g)	Dimensioni (mm) Dimensions (mm)			Coefficienti di carico (N) Basic load rating (N)		Velocità limite Limiting Speed
			F _w	E _w	B _c	Dinamico C Dynamic C	Statico C _s Static C _s	Olio (N. giri max) Oil (max rpm)
14	K 14x18x17	8.1	14	18	17	10 500	13 900	23 750
	K 14x20x12	8.6	14	20	12	9 900	10 500	22 800
15	K 15x18x14	5.3	15	18	14	7 500	11 000	22 800
	K 15x18x17	6.4	15	18	17	9 600	15 900	23 750
	K 15x19x10	5.1	15	19	10	7 200	9 000	22 800
	K 15x19x13	7	15	19	13	8 300	9 800	22 800
	K 15x19x17	8.8	15	19	17	10 300	15 000	22 800
	K 15x19x24	10.5	15	19	24	12 800	20 100	22 800
	K 15x20x13	8.9	15	20	13	9 700	11 000	22 800
	K 15x21x12	10	15	21	12	10 000	13 000	22 800
	K 15x21x15	13	15	21	15	13 800	16 000	22 800
	K 15x21x21	18.2	15	21	21	18 000	24 000	22 800
16	K 16x20x10	5.7	16	20	10	7 600	9 700	22 800
	K 16x20x13	7.1	16	20	13	8 700	11 300	22 800
	K 16x20x17	9.2	16	20	17	11 200	16 300	22 800
	K 16x21x10	6.7	16	21	10	9 000	12 000	22 800
	K 16x22x12	10.4	16	22	12	11 000	12 000	21 850
	K 16x22x13	11.9	16	22	13	12 000	13 400	21 850
	K 16x22x16	13.7	16	22	16	14 300	17 000	21 850
	K 16x22x20	16.7	16	22	20	18 000	22 300	21 850
	K 16x23x14	20	16	23	14	19 000	21 000	20 000
K 16x24x20	24.9	16	24	20	21 100	23 000	20 900	
17	K 17x21x10	5.6	17	21	10	7 900	10 100	21 850
	K 17x21x13	7.5	17	21	13	10 000	14 100	21 850
	K 17x21x17	9.5	17	21	17	12 000	17 400	21 850
	K 17x23x14	11.5	17	23	14	11 000	15 000	21 850
18	K 18x22x10	6.1	18	22	10	8 200	9 900	20 900
	K 18x22x13	7.7	18	22	13	9 000	12 100	20 900
	K 18x22x17	10.8	18	22	17	11 900	17 600	20 900
	K 18x24x12	11.6	18	24	12	12 150	14 150	20 900
	K 18x24x13	12.6	18	24	13	12 900	14 900	20 900
	K 18x24x13.5	13	18	24	13.5	12 900	14 900	20 900
	K 18x24x20	19	18	24	20	20 000	26 500	20 900
	K 18x25x14	14.9	18	25	14	16 500	18 800	20 900
	K 18x25x22	24.3	18	25	22	22 900	28 400	20 900
	K 18x26x14	19	18	26	14	18 000	20 000	20 900
K 18x28x16	24	18	28	16	19 000	18 400	20 900	
19	K 19x23x13	8.2	19	23	13	9 300	13 000	20 900
	K 19x23x17	11.1	19	23	17	12 000	18 600	20 900

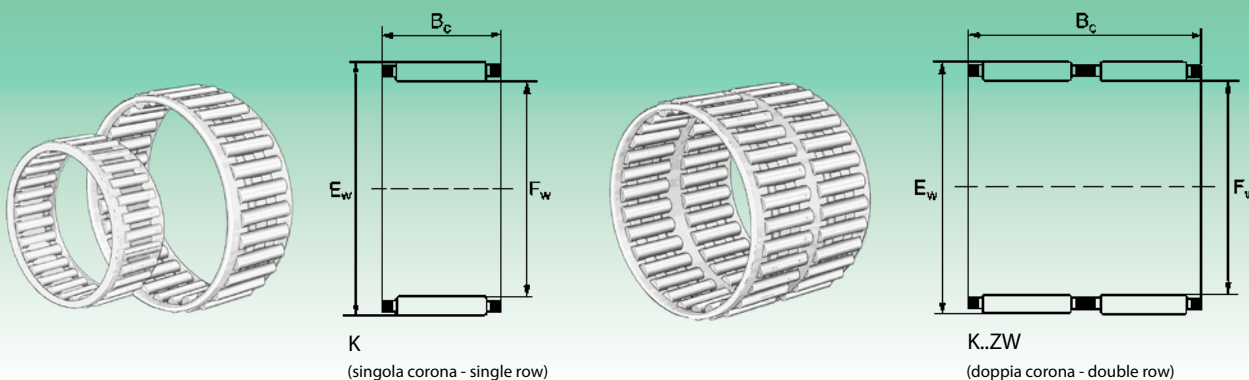

Diametro albero (mm) Shaft diameter (mm)	Sigla Designation	Peso (g) Weight (g)	Dimensioni (mm) Dimensions (mm)			Coefficienti di carico (N) Basic load rating (N)		Velocità limite Limiting Speed Olio (N. giri max) Oil (max rpm)
			F _w	E _w	B _c	Dinamico C Dynamic C	Statico C ₀ Static C ₀	
20	K 20x24x10	6.5	20	24	10	8 700	12 100	19 950
	K 20x24x12	8	20	24	12	9 600	13 800	19 950
	K 20x24x13	8.9	20	24	13	9 600	13 800	19 950
	K 20x24x17	11.2	20	24	17	12 400	20 000	19 950
	K 20x26x12	13.2	20	26	12	13 100	15 700	19 950
	K 20x26x13	14.3	20	26	13	14 100	17 400	19 950
	K 20x26x14	15	20	26	14	15 000	18 000	19 950
	K 20x26x16	17.5	20	26	16	18 000	25 000	19 950
	K 20x26x17	18.2	20	26	17	18 700	25 500	19 950
	K 20x26x20	22	20	26	20	20 600	28 500	19 950
	K 20x28x16	20	20	28	16	19 000	20 000	19 000
	K 20x28x20	26.8	20	28	20	23 400	28 000	19 000
K 20x28x25	36.2	20	28	25	30 000	38 500	19 000	
K 20x30x30	56	20	30	30	35 000	41 000	19 000	
21	K 21x25x13	9	21	25	13	9 600	14 500	19 950
	K 21x25x17	12	21	25	17	12 800	21 000	19 950
22	K 22x26x10	7.1	22	26	10	8 700	12 900	19 000
	K 22x26x13	9.4	22	26	13	10 000	15 400	19 000
	K 22x26x17	12.1	22	26	17	13 100	22 100	19 000
	K 22x27x13	10.8	22	27	13	14 000	23 000	19 000
	K 22x28x17	19.7	22	28	17	19 000	26 500	19 000
	K 22x28x23	26	22	28	23	20 000	27 000	19 000
	K 22x29x16	22.2	22	29	16	19 500	25 000	18 000
	K 22x30x15 TN	18	22	30	15	19 600	22 900	18 000
	K 22x30x20	28	22	30	20	21 000	23 500	18 000
K 22x32x24	43.4	22	32	24	33 500	39 500	17 000	
23	K 23x35x16 TN	30	23	35	16	24 000	23 400	16 150
24	K 24x28x10	8.1	24	28	10	9 400	14 300	18 000
	K 24x28x13	10.1	24	28	13	10 500	17 000	18 000
	K 24x28x17	13.2	24	28	17	14 000	24 500	18 000
	K 24x29x13	13.5	24	29	13	13 100	19 100	17 000
	K 24x30x17	21.5	24	30	17	19 000	27 000	17 000
	K 24x30x31 - ZW	39.1	24	30	31	27 000	43 000	17 000
25	K 25x29x10	8.3	25	29	10	9 700	14 900	17 000
	K 25x29x13	10.4	25	29	13	10 800	17 900	17 000
	K 25x29x17	13.7	25	29	17	14 500	25 500	17 000
	K 25x30x13	12.9	25	30	13	14 100	21 300	17 000
	K 25x30x17	16	25	30	17	17 800	28 500	17 000
	K 25x30x20	20.5	25	30	20	21 100	34 675	17 000
K 25x30x25	21	25	30	25	21 700	40 400	17 000	

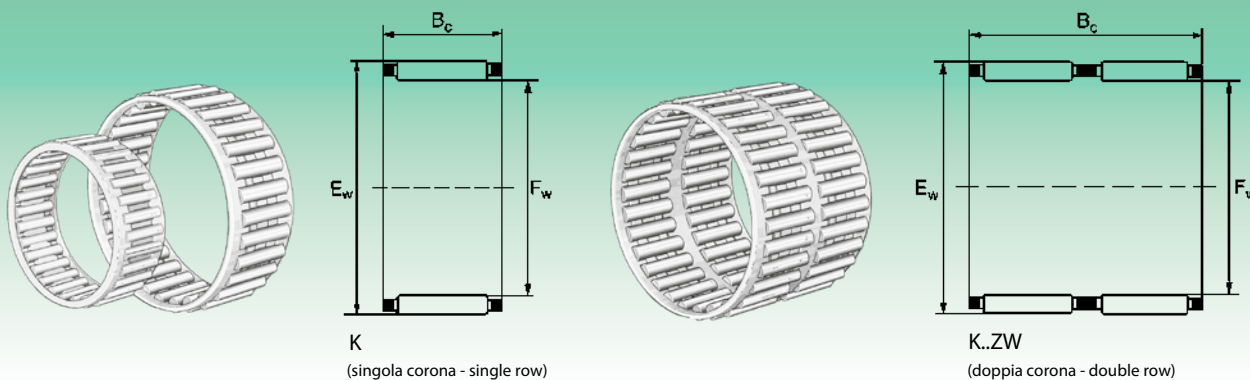
Gabbie a rullini singola e doppia corona (serie K • K..ZW)
Needle roller and cage assemblies single/double row (K • K..ZW series)

Diametro albero (mm) Shaft diameter (mm)	Sigla Designation	Peso (g) Weight (g)	Dimensioni (mm) Dimensions (mm)			Coefficienti di carico (N) Basic load rating (N)		Velocità limite Limiting Speed Olio (N. giri max) Oil (max rpm)
			F _w	E _w	B _c	Dinamico C Dynamic C	Statico C ₀ Static C ₀	
25	K 25x30x26	21.6	25	30	26	20 100	26 500	17 000
	K 25x30x26 - ZW	27	25	30	26	21 000	35 000	15 000
	K 25x31x17	21.8	25	31	17	19 000	28 000	17 000
	K 25x31x21	26.2	25	31	21	24 100	37 500	17 000
	K 25x32x16	24.5	25	32	16	20 500	27 500	16 150
	K 25x33x20	32	25	33	20	28 000	37 500	16 150
	K 25x33x24	38.7	25	33	24	33 900	46 500	16 150
	K 25x34x18	32	25	34	18	48 000	67 000	16 150
	K 25x35x30	65.5	25	35	30	46 500	61 500	15 200
26	K 26x30x10	9	26	30	10	9 500	15 500	17 000
	K 26x30x13	11.4	26	30	13	11 100	18 700	17 000
	K 26x30x17	15	26	30	17	14 700	27 000	17 000
	K 26x30x22 - ZW	12.3	26	30	22	15 200	28 000	17 000
	K 26x31x13	9.9	26	31	13	12 400	18 400	17 000
27	K 27x32x27	29	27	32	27	16 000	34 000	17 000
28	K 28x32x16.5	18	28	32	16.5	15 000	32 400	15 200
	K 28x32x17	18.2	28	32	17	15 000	32 400	15 200
	K 28x33x13	15.2	28	33	13	14 800	23 600	15 200
	K 28x33x17	19.5	28	33	17	19 100	33 000	15 200
	K 28x33x27 TN	19	28	33	27	22 800	40 500	15 200
	K 28x34x17	24.2	28	34	17	21 300	35 000	15 200
	K 28x35x16	29	28	35	16	21 000	29 000	15 200
	K 28x35x18	31	28	35	18	23 500	33 500	15 200
	K 28x35x20	35	28	35	20	24 000	34 000	15 200
	K 28x35x27	47	28	35	27	34 500	54 500	15 200
	K 28x36x16	40	28	36	16	31 000	47 000	15 200
	K 28x40x18	50	28	40	18	33 000	36 500	13 300
	K 28x40x25	71	28	40	25	45 000	54 500	13 300
30	K 30x34x13	14.6	30	34	13	11 800	21 200	14 250
	K 30x35x13	16.3	30	35	13	15 100	25 000	14 250
	K 30x35x17	21.3	30	35	17	19 100	33 500	14 250
	K 30x35x26 - ZW	32	30	35	26	23 500	43 500	13 000
	K 30x35x27	33.3	30	35	27	30 000	58 500	14 250
	K 30x37x16	26.4	30	37	16	22 500	33 000	14 250
	K 30x37x18	34	30	37	18	25 500	38 000	14 250
	K 30x38x25	43	30	38	25	26 000	39 000	14 250
	K 30x40x18	44	30	40	18	31 500	39 500	13 300
	K 30x40x30	78	30	40	30	48 500	68 500	14 250

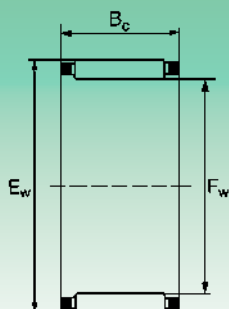
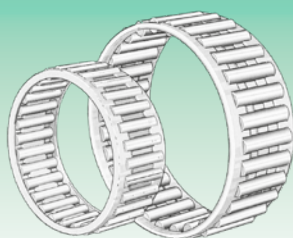
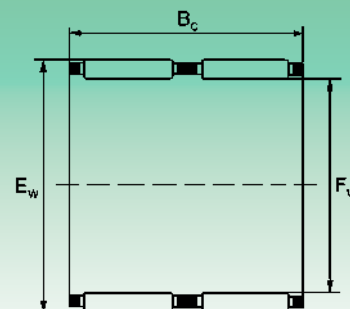
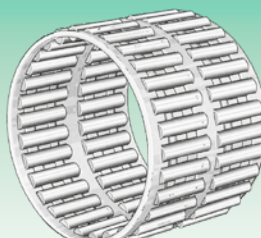
K
(singola corona - single row)

K..ZW
(doppia corona - double row)

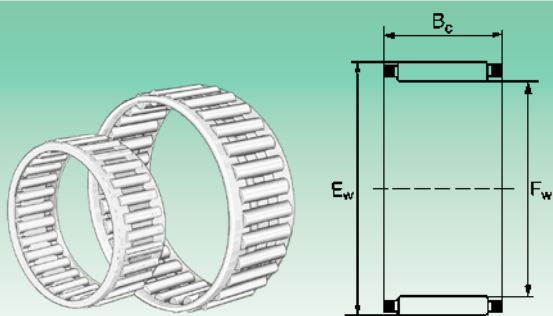
Diametro albero (mm) Shaft diameter (mm)	Sigla Designation	Peso (g) Weight (g)	Dimensioni (mm) Dimensions (mm)			Coefficienti di carico (N) Basic load rating (N)		Velocità limite Limiting Speed
			F _w	E _w	B _c	Dinamico C Dynamic C	Statico C ₀ Static C ₀	Olio (N. giri max) Oil (max rpm)
32	K 32x37x13	18.3	32	37	13	15 000	25 000	13 300
	K 32x37x17	22.4	32	37	17	19 400	35 000	13 300
	K 32x37x27	36.7	32	37	27	29 500	59 500	13 300
	K 32x37x28 TN	22.3	32	37	28	23 100	43 000	13 300
	K 32x38x16	25	32	38	16	21 000	34 000	13 300
	K 32x38x20	31	32	38	20	26 000	44 500	13 300
	K 32x38x26 TN	25.2	32	38	26	27 000	46 500	13 300
	K 32x39x16	36.7	32	39	16	23 500	35 000	13 300
	K 32x39x18	37.2	32	39	18	26 000	40 500	13 300
	K 32x40x20	48	32	40	20	37 000	40 500	13 300
	K 32x40x25	54	32	40	25	37 000	57 500	13 300
	K 32x40x36	73	32	40	36	53 500	91 500	13 300
35	K 32x40x42 TN - ZW	77.1	32	40	42	49 500	83 500	12 350
	K 32x46x32	119	32	46	32	65 500	82 500	12 350
	K 35x40x13	18.8	35	40	13	15 800	27 500	12 350
	K 35x40x17	25.3	35	40	17	20 300	38 000	12 350
	K 35x40x25	31	35	40	25	29 000	59 500	12 350
	K 35x40x27 TN	23.4	35	40	27	24 500	48 000	12 350
	K 35x40x30 - ZW	48	35	40	30	25 500	50 500	11 000
	K 35x40x32 - ZW	50	35	40	32	30 500	64 500	11 000
	K 35x42x16	34	35	42	16	23 900	37 000	12 350
	K 35x42x18	39.2	35	42	18	27 000	42 500	12 350
	K 35x42x20	41	35	42	20	29 500	48 500	11 000
	K 35x42x30	62.4	35	42	30	38 500	67 500	12 350
36	K 35x43x18	38	35	43	18	28 000	41 500	12 350
	K 35x45x20	55.5	35	45	20	36 500	49 500	11 400
	K 35x45x30	80	35	45	30	52 500	78 500	11 400
	K 35x45x49	138	35	45	49	81 500	13 400	11 400
	K 36x41x30	52	36	41	30	23 000	43 000	11 400
	K 36x42x16	50	36	42	16	24 000	42 000	11 400
37	K 37x42x17	25.8	37	42	17	21 900	42 500	11 400
	K 37x42x27	40.7	37	42	27	31 500	67 500	11 400
	K 37x45x26	60.5	37	45	26	43 500	73 500	11 400
38	K 38x43x17	26.1	38	43	17	20 000	38 000	11 400
	K 38x43x27	43.2	38	43	27	31 000	67 500	11 400
	K 38x46x20	46	38	46	20	35 000	56 500	11 400
	K 38x46x32	72.7	38	46	32	54 500	98 500	11 400
39	K 39x44x24	38	39	44	24	28 000	58 500	11 400
	K 39x44x26 - ZW	29.5	39	44	26	27 000	55 500	11 400

Gabbie a rullini singola e doppia corona (serie K • K..ZW)
Needle roller and cage assemblies single/double row (K • K..ZW series)

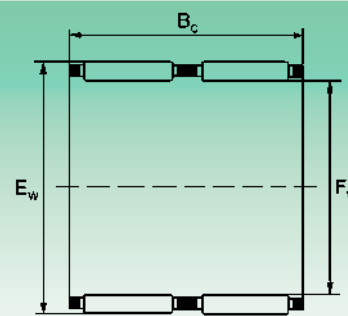
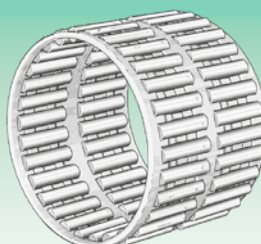
K
(singola corona - single row)



K..ZW
(doppia corona - double row)

Diametro albero (mm) Shaft diameter (mm)	Sigla Designation	Peso (g) Weight (g)	Dimensioni (mm) Dimensions (mm)			Coefficienti di carico (N) Basic load rating (N)		Velocità limite Limiting Speed Olio (N. giri max) Oil (max rpm)
			F _w	E _w	B _c	Dinamico C Dynamic C	Statico C _s Static C _s	
40	K 40x44x13	20	40	44	13	13 500	28 000	11 400
	K 40x45x13	21.5	40	45	13	17 100	32 000	11 400
	K 40x45x17	27.4	40	45	17	20 900	41 000	11 400
	K 40x45x21	36.5	40	45	21	24 400	49 500	11 400
	K 40x45x27	46	40	45	27	32 500	72 500	11 400
	K 40x45x30	48	40	45	30	26 000	53 500	10 000
	K 40x46x17	45.2	40	46	17	29 000	49 500	10 450
	K 40x47x18	42	40	47	18	32 000	56 500	10 450
42	K 40x47x20	57.7	40	47	20	35 500	58 500	10 450
	K 40x48x20	30	40	48	20	24 500	44 500	10 450
	K 42x47x13	22.5	42	47	13	17 300	33 000	10 450
	K 42x47x17	31.1	42	47	17	21 100	42 500	10 450
	K 42x47x25 TN	25.7	42	47	25	27 000	57 500	10 450
	K 42x47x27	46.6	42	47	27	33 000	74 500	10 450
	K 42x47x30 - ZW	54	42	47	30	31 000	75 500	10 450
43	K 42x48x35	53	42	48	35	31 000	49 500	10 450
	K 42x50x18	54	42	50	18	34 500	56 500	10 450
	K 42x50x20	60	42	50	20	35 000	76 000	10 450
43	K 43x48x17	29.3	43	48	17	21 000	42 500	10 450
	K 43x48x27	45.7	43	48	27	33 000	74 500	10 450
	K 43x50x18	48.5	43	50	18	30 500	53 500	10 450
45	K 45x49x19	27	45	49	19	17 500	40 000	9 500
	K 45x50x17	25.5	45	50	17	22 000	45 500	9 500
	K 45x50x27	50	45	50	27	34 000	79 500	9 500
	K 45x50x32 TN	45	45	50	32	38 000	90 500	9 500
	K 45x51x36	85	45	51	36	44 500	98 500	9 500
	K 45x52x18	32.9	45	52	18	39 500	57 500	9 500
	K 45x52x21 TN	62.2	45	52	21	38 500	66 500	9 500
	K 45x53x20	65	45	53	20	38 000	66 500	9 500
	K 45x53x21	68.4	45	53	21	42 000	72 200	9 500
	K 45x53x22	78	45	53	22	51 500	97 500	9 500
	K 45x53x28	60.5	45	53	28	43 500	53 500	9 000
	K 45x59x18 TN	145.5	45	59	18	72 500	101 500	9 000
47	K 45x59x32	159	45	59	32	75 500	108 500	9 000
	K 45x59x36	51	45	59	36	31 000	56 500	9 500
	K 47x52x17	32	47	52	17	22 800	48 500	9 500
	K 47x52x27	50.7	47	52	27	34 500	82 500	9 500
	K 47x53x25	53	47	53	25	38 000	81 500	9 500
	K 47x55x28	80	47	55	28	52 500	99 500	9 500

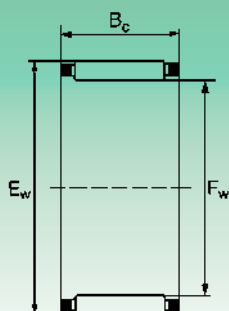
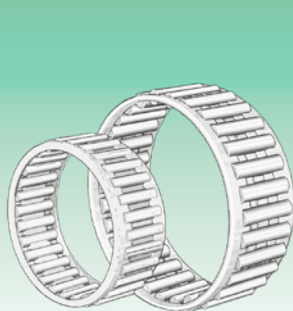

K
(singola corona - single row)

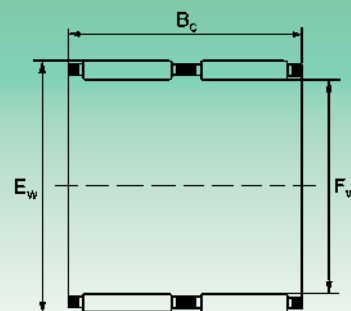
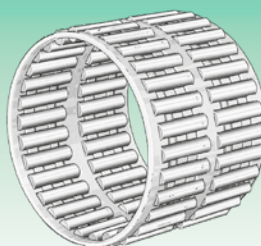

K..ZW
(doppia corona - double row)

Diametro albero (mm) Shaft diameter (mm)	Sigla Designation	Peso (g) Weight (g)	Dimensioni (mm) Dimensions (mm)			Coefficienti di carico (N) Basic load rating (N)		Velocità limite Limiting Speed	
			F _w	E _w	B _c	Dinamico C Dynamic C	Statico C ₀ Static C ₀	Olio (N. giri max) Oil (max rpm)	
48	K 48x54x19	44	48	54	19	30 000	60 500	9 500	
	K 48x54x25	55	48	54	25	31 000	61 000	9 500	
50	K 50x55x13.5	31	50	55	13.5	17 500	36 000	9 000	
	K 50x55x17	35	50	55	17	21 400	46 500	9 000	
	K 50x55x20	39.4	50	55	20	26 000	59 500	9 000	
	K 50x55x30	59.4	50	55	30	38 500	96 500	9 000	
	K 50x57x18	53.4	50	57	18	33 000	62 500	8 500	
	K 50x58x20	75	50	58	20	35 000	61 500	8 500	
52	K 50x58x25	81	50	58	25	43 500	80 500	8 500	
55	K 52x57x12	24	52	57	12	17 500	36 000	8 500	
	K 55x60x20	43.4	55	60	20	28 000	65 500	8 000	
	K 55x60x27	60.5	55	60	27	37 500	96 500	8 000	
	K 55x60x30	68.6	55	60	30	40 500	103 000	8 000	
	K 55x60x40 - ZW	96.5	55	60	40	48 000	132 000	8 000	
	K 55x61x20	58.4	55	61	20	35 000	69 500	8 000	
	K 55x62x18	53	55	62	18	24 500	40 500	8 000	
	K 55x63x15	73.3	55	63	15	39 500	73 500	8 000	
	K 55x63x20	88	55	63	20	49 500	99 500	8 000	
56	K 55x63x25	117	55	63	25	61 500	129 500	8 000	
	K 55x63x32	56	55	63	32	41 000	110 000	8 000	
	K 56x61x20	45	56	61	20	27 000	64 500	8 000	
	58	K 58x63x17	42	58	63	17	25 650	63 500	8 000
		K 58x64x19	53	58	64	19	33 250	77 500	7 600
		K 58x65x18	52	58	65	18	34 500	69 500	7 600
		K 58x65x36 - ZW	106	58	65	36	48 500	106 500	7 600
	60	K 60x65x20	50.5	60	65	20	29 000	71 500	7 600
		K 60x65x30	71.2	60	65	30	42 000	115 500	7 600
K 60x66x33 - ZW		104	60	66	33	45 500	111 500	7 600	
K 60x66x40 - ZW		116	60	66	40	57 500	150 500	7 600	
K 60x68x20		79	60	68	20	43 000	84 500	7 100	
K 60x68x23		94	60	68	23	49 000	100 500	7 100	
K 60x68x25		97	60	68	25	52 500	110 500	7 100	
K 60x68x27		98	60	68	27	49 500	100 000	7 100	
K 60x68x30 - ZW		136	60	68	30	44 000	87 500	7 100	
62	K 60x68x34 - ZW	140	60	68	34	47 500	95 500	7 100	
	K 60x75x42	240	60	75	42	113 000	192 000	7 100	
63	K 62x70x40 - ZW	174	62	70	40	65 500	145 500	7 100	
64	K 63x70x21	75	63	70	21	45 000	100 500	7 100	
64	K 64x70x16	53	64	70	16	27 500	59 500	7 100	

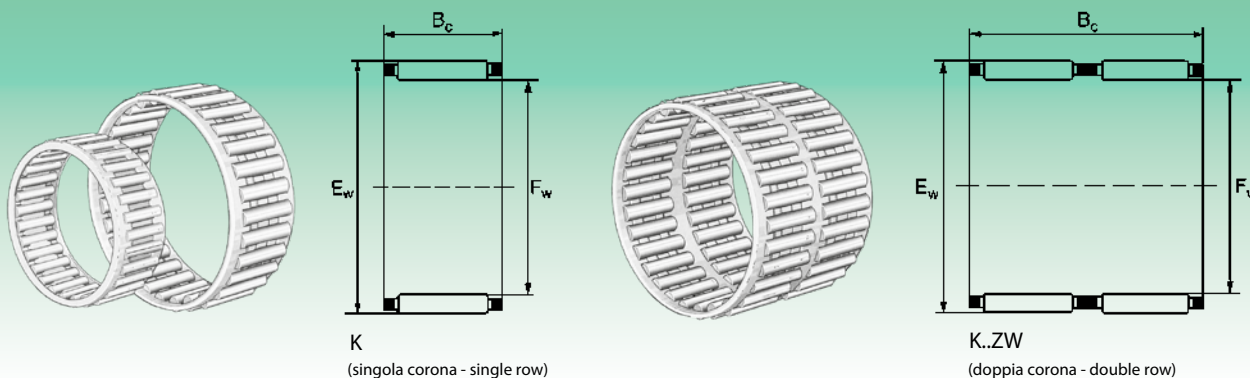
Gabbie a rullini singola e doppia corona (serie K • K..ZW)
Needle roller and cage assemblies single/double row (K • K..ZW series)

Diametro albero (mm) Shaft diameter (mm)	Sigla Designation	Peso (g) Weight (g)	Dimensioni (mm) Dimensions (mm)			Coefficienti di carico (N) Basic load rating (N)		Velocità limite Limiting Speed
			F _w	E _w	B _c	Dinamico C Dynamic C	Statico C _s Static C _s	Olio (N. giri max) Oil (max rpm)
65	K 65x70x20	49	65	70	20	30 000	76 500	7 100
	K 65x70x30	83	65	70	30	43 500	123 500	7 100
	K 65x73x23	100	65	73	23	45 500	93 500	6 650
	K 65x73x30	141	65	73	30	56 500	122 500	6 650
68	K 68x74x20	65	68	74	20	35 000	83 500	6 650
	K 68x74x30	97	68	74	30	46 000	117 500	6 650
	K 68x74x35 - ZW	116	68	74	35	48 000	124 500	6 650
70	K 70x76x20	70	70	76	20	35 500	85 500	6 200
	K 70x76x30	100	70	76	30	51 500	138 500	6 200
	K 70x78x25	115	70	78	25	51 500	111 500	6 200
	K 70x78x30	136	70	78	30	59 500	134 500	6 200
	K 70x78x46 - ZW	230	70	78	46	77 500	179 550	6 200
	K 70x80x30	150	70	80	30	60 000	135 000	6 200
72	K 72x80x20	94	72	80	20	41 000	84 500	6 200
73	K 73x79x20	69	73	79	20	36 500	85 500	6 200
75	K 75x81x20	72	75	81	20	37 000	93 500	6 200
	K 75x81x30	106	75	81	30	51 500	142 000	6 200
	K 75x83x23	113	75	83	23	49 500	108 000	5 700
	K 75x83x30	147	75	83	30	61 500	142 000	5 700
	K 75x83x35 - ZW	182	75	83	35	62 500	146 500	5 700
	K 75x83x40 - ZW	211	75	83	40	72 500	176 500	5 700
80	K 80x86x20	76	80	86	20	38 000	97 500	5 700
	K 80x86x30	114	80	86	30	55 500	158 500	5 700
	K 80x88x30	141	80	88	30	71 500	178 500	5 700
	K 80x88x40 - ZW	227	80	88	40	75 500	191 500	5 700
	K 80x88x46 - ZW	260	80	88	46	87 500	219 450	5 700
85	K 85x92x20	96	85	92	20	44 000	107 500	5 200
90	K 90x97x20	103	90	97	20	44 500	112 500	4 750
	K 90x98x27	150	90	98	27	60 500	149 500	4 750
	K 90x98x30	172	90	98	30	67 500	171 500	4 750
95	K 95x102x20	110	95	102	20	45 500	122 500	4 500
	K 95x103x30	177	95	103	30	68 500	179 500	4 500
	K 95x103x40 - ZW	260	95	103	40	82 500	227 500	4 500
100	K 100x107x21	120	100	107	21	47 500	126 500	4 300
	K 100x108x27	176	100	108	27	56 500	142 500	4 300
	K 100x108x30	190	100	108	30	70 500	187 500	4 300
105	K 105x112x21	123	105	112	21	47 000	126 500	4 200
	K 105x113x30	216	105	113	30	71 500	196 500	4 200
110	K 110x117x24	172	110	117	24	55 500	157 500	4 100
	K 110x118x30	217	110	118	30	77 500	218 500	4 100

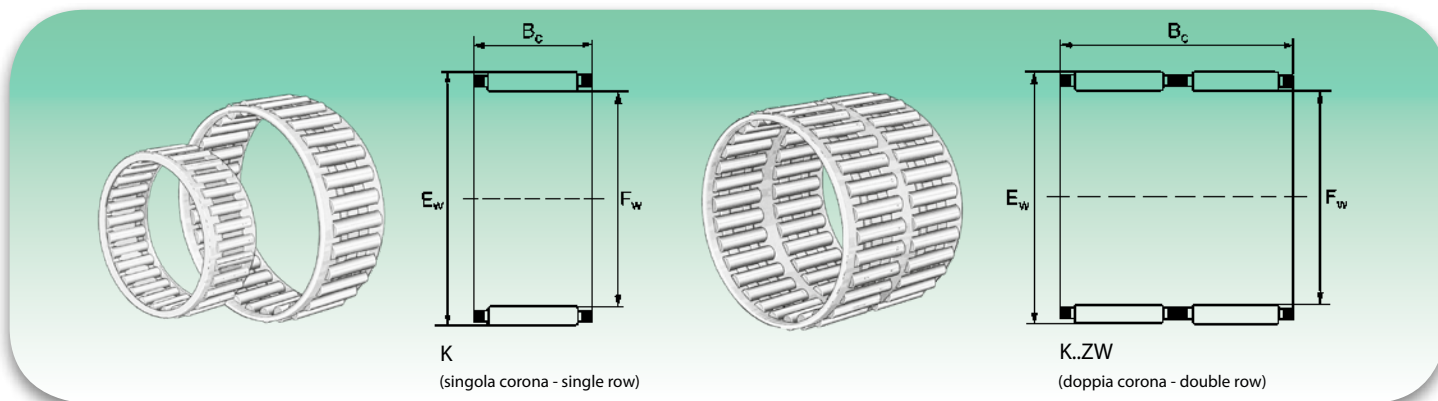

Diametro albero (mm) Shaft diameter (mm)	Sigla Designation	Peso (g) Weight (g)	Dimensioni (mm) Dimensions (mm)			Coefficienti di carico (N) Basic load rating (N)		Velocità limite Limiting Speed Olio (N. giri max) Oil (max rpm)
			F _w	E _w	B _c	Dinamico C Dynamic C	Statico C _s Static C _s	
115	K 115x123x27	200	115	123	27	59 850	161 500	4 000
120	K 120x127x24	165	120	127	24	56 050	165 300	3 900
	K 120x127x34	222	120	127	34	76 950	247 000	3 900
125	K 125x133x35	275	125	133	35	81 700	247 000	3 700
130	K 130x137x24	170	130	137	24	57 950	176 700	3 600
135	K 135x143x35	300	135	143	35	86 450	275 500	3 400
145	K 145x153x26	262	145	153	26	70 300	213 750	3 200
	K 145x153x36	300	145	153	36	93 100	308 750	3 200
150	K 150x160x46	570	150	160	46	139 650	446 500	3 100
155	K 155x163x26	265	155	163	26	71 250	224 200	3 000
	K 155x163x36	356	155	163	36	95 000	323 000	3 000
160	K 160x170x46	550	160	170	46	144 400	484 500	2 900
165	K 165x173x26	320	165	173	26	76 950	251 750	2 800
170	K 170x180x46	600	170	180	46	150 100	513 000	2 700
175	K 175x183x32	400	175	183	32	94 050	332 500	2 600
185	K 185x195x37	607	185	195	37	121 600	403 750	2 500
195	K 195x205x37	620	195	205	37	126 350	427 500	2 400
210	K 210x220x42	740	210	220	42	146 300	532 000	2 200
220	K 220x230x42	790	220	230	42	150 100	560 500	2 100
240	K 240x250x42	850	240	250	42	155 800	598 500	1 900
265	K 265x280x50	1 810	265	280	50	242 250	817 000	1 700

TN= Gabbia in plastica, temperatura d'esercizio ammissibile: 80°C (per funzionamento continuo).

TN= Plastic cage; temperature allowed: 80°C (continuous working).

In caso di lubrificazione a grasso, è ammesso un n° di giri pari al 60% dei valori riportati in tabella.

For grease lubrication number of allowed revolution is 60% of value expressed in table (see specifications for different grease).

- = Su richiesta.
- = Under request.



GABBIE A RULLINI PER IMBIELLAGGI

*NEEDLE ROLLER AND CAGE ASSEMBLIES FOR
CONNECTING ROD BEARINGS ARRANGEMENTS*





Gabbie a rullini per imbiellaggi**Needle roller and cage assemblies for connecting rod bearings arrangements**

Le gabbie a rullini per imbiellaggi vengono solitamente utilizzate nei manovellismi dei motori a combustione interna. Sono state appositamente progettate per esigenze specifiche, come ad esempio forze centrifughe e numero di giri elevati. Esistono due diversi tipi di gabbie a rullini per imbiellaggi, una viene montata sull'albero a motore e prende il nome di KZK, mentre l'altra viene montata sulla testa di biella e prende il nome di KBK.

Gabbie a rullini (serie KZK)

Sono utilizzate principalmente quando si è in presenza di forze centrifughe molto elevate. La gabbia viene guidata sul foro di biella per limitarne il giuoco ed il movimento. Le gabbie a rullini per imbiellaggi sono trattate in modo particolare per avere un'alta resistenza ed una minima usura, hanno dimensioni ridotte perciò riescono a raggiungere notevoli velocità.

Gabbie a rullini (serie KBK)

Sono utilizzate principalmente quando si è in presenza di carichi oscillanti, vengono guidate sullo spinotto con un giuoco radiale molto limitato. Hanno in linea di massima le medesime caratteristiche delle KZK.

The needle roller and cage assemblies for connecting rod, are particularly studied and employed in case of high number of revolutions or centrifugal forces: they are mounted in cranks of internal combustion engines.

They are subdivided in two series: KZK for big end of the connecting rod, and KBK for connecting rod small ends.

Needle roller and cage assemblies (KZK series)

Utilised when very high centrifugal forces are present, cage is guided on crank pin's bore of connecting rod in order to avoid clearance and movement.

These cages are treated in a particular way to obtain highest resistance and lowest wear; thanks to their small dimensions are able to reach high speeds.

Needle roller and cages assemblies (KBK series)

Mainly requested in presence of oscillating loads and guided on piston pin, that have a very small radial clearance.

For other characteristics, see KZK cages.

Esempio di montaggio
Mounting example

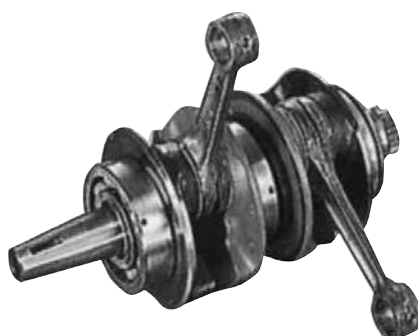

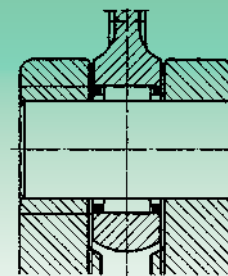
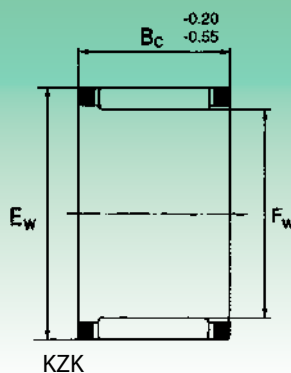

Diametro albero (mm) Shaft diameter (mm)	Sigla Designation	Peso (g) Weight (g)	Dimensioni (mm) Dimensions (mm)			Coefficienti di carico (N) Basic load ratings (N)	
			F _w	E _w	B _c	Dinamico C Dynamic C	Statico C ₀ Static C ₀
8	KZK 8x12x8	1.9	8	12	8	4 700	4 580
10	KZK 10x14x10	3.3	10	14	10	5 000	5 160
12	KZK 12x15x13	3.6	12	15	13	5 300	7 400
	KZK 12x16x10	3.5	12	16	10	6 100	6 900
	KZK 12x16x11	3.7	12	16	11	6 200	7 100
	KZK 12x17x10	5	12	17	10	7 020	7 020
	KZK 12x18x10	7.8	12	18	10	7 400	7 200
14	KZK 14x18x10	4	14	18	10	7 100	8 500
	KZK 14x19x10	5.5	14	19	10	7 300	7 600
	KZK 14x19x12	7.5	14	19	12	7 460	7 950
	KZK 14.4x20.4x10	6.5	14.4	20.4	10	8 100	7 800
15	KZK 15x19x9	5	15	19	9	6 800	7 100
	KZK 15x19x10	6	15	19	10	7 200	8 400
	KZK 15x20x10	7.5	15	20	10	7 800	9 100
	KZK 15x21x10	8.5	15	21	10	8 400	10 500
	KZK 15x21x11	9.5	15	21	11	8 500	10 700
	KZK 15.2x22.2x12	11.5	15.2	22.2	12	8 600	11 100
16	KZK 16x20x10	5.8	16	20	10	8 200	9 200
	KZK 16x20x24	6.3	16	20	24	8 700	9 400
	KZK 16x21x10	5.8	16	21	10	8 800	9 800
	KZK 16x22x12	9.5	16	22	12	11 000	11 900
	KZK 16x22x14	11	16	22	14	13 200	13 930
17	KZK 17x21x10	6.7	17	21	10	7 600	9 000
	KZK 17x23x11	9.5	17	23	11	8 100	11 300
18	KZK 18x22x10	6.9	18	22	10	7 600	9 800
	KZK 18x22x24	7.2	18	22	24	10 100	17 200
	KZK 18x24x11.6	10	18	24	11.6	11 600	13 100
	KZK 18x24x12	10	18	24	12	11 600	13 100
	KZK 18x24x13.3	12.4	18	24	13.3	9 000	10 700
	KZK 18x24x13.5	12.4	18	24	13.5	9 000	10 700
	KZK 18x24x15	14	18	24	15	13 200	15 500
19	KZK 19x25x16	13.9	19	25	16	12 100	15 500
	KZK 19x28x14	20	19	28	14	12 100	15 000
20	KZK 20x25x16	12	20	25	16	9 900	12 300
	KZK 20x26x12	9.6	20	26	12	10 100	12 500
	KZK 20x26x14	12	20	26	14	12 600	16 700
	KZK 20x26x17	17	20	26	17	14 535	18 145
22	KZK 22x28x13	15	22	28	13	13 205	16 500
	KZK 22x28x14	16	22	28	14	12 600	16 800
	KZK 22x28x15	16.7	22	28	15	13 500	18 500

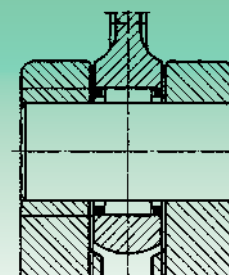
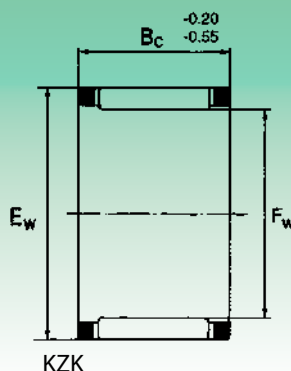
Gabbie a rullini per imbiellaggi, supporto bottone di manovella (serie KZK)
Needle roller and cage assemblies for crank pin of connecting rod (KZK series)

Diametro albero (mm) Shaft diameter (mm)	Sigla Designation	Peso (g) Weight (g)	Dimensioni (mm) Dimensions (mm)			Coefficienti di carico (N) Basic load ratings (N)	
			F _w	E _w	B _c	Dinamico C Dynamic C	Statico C ₀ Static C ₀
22	KZK 22x28x13	15	22	28	13	13 205	16 625
	KZK 22x28x16	18	22	28	16	14 400	20 100
	KZK 22x29x15	15.2	22	29	15	17 800	21 800
	KZK 22x29x16	19	22	29	16	17 800	21 800
	KZK 22x30x16	25.7	22	30	16	18 700	22 300
23	KZK 23x29x13	12	23	29	13	10 000	11 300
	KZK 23x30x14	19.4	23	30	14	9 350	10 100
	KZK 23x30x16	22	23	30	16	9 780	11 800
23.1	KZK 23.1x28.1x14	12.9	23.1	28.1	14	10 600	15 800
24	KZK 24x30x15	17	24	30	15	11 200	13 700
	KZK 24x30x16	18	24	30	16	11 200	13 700
25	KZK 25x30x28	24	25	30	28	13 300	15 200
	KZK 25x31x12	16	25	31	12	8 700	8 800
	KZK 25x31x17	23	25	31	17	9 200	9 750
	KZK 25x31x20	26	25	31	20	9 700	10 600
	KZK 25x32x16	22.7	25	32	16	18 200	23 100
25.1	KZK 25.1x30.1x14	14.1	25.1	30.1	14	13 700	19 000
26	KZK 26x34x16	25	26	34	16	11 700	17 500
28	KZK 28x33x14	15.7	28	33	14	13 200	21 900
	KZK 28x34x14	20	28	34	14	16 500	20 700
	KZK 28x35x15	25	28	35	15	18 000	22 000
	KZK 28x35x16	27	28	35	16	18 900	23 000
	KZK 28x36x16	29.1	28	36	16	19 500	27 000
	KZK 28x38x13.6	40	28	38	13.6	17 300	20 300
30	KZK 30x36x16	28.5	30	36	16	18 900	22 800
	KZK 30x37x16	29	30	37	16	21 500	30 500
	KZK 30x38x16	34.4	30	38	16	22 700	32 600
	KZK 30x38x18	38.8	30	38	18	26 200	39 600
32	KZK 32x40x22	50	32	40	22	27 800	39 300
	KZK 32x42x20	54	32	42	20	29 000	41 000
35	KZK 35x42x20	40	35	42	20	26 000	40 500
38	KZK 38x46x20	50	38	46	20	31 100	43 000
40	KZK 40x48x17	50	40	48	17	29 000	39 000
	KZK 40x48x20	54	40	48	20	32 500	51 000

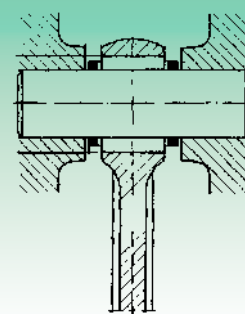
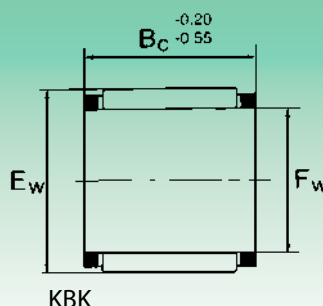
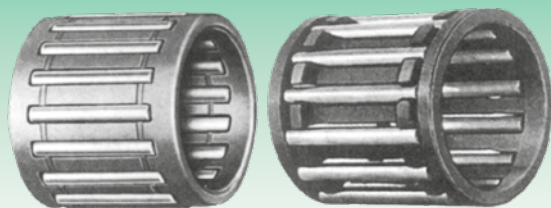

Diametro albero (mm) Shaft diameter (mm)	Sigla Designation	Peso (g) Weight (g)	Dimensioni (mm) Dimensions (mm)			Coefficienti di carico (N) Basic load ratings (N)	
			F _w	E _w	B _c	Dinamico C Dynamic C	Statico C ₀ Static C ₀
8	KBK 8x11x10	1.85	8	11	10	3 500	4 000
	KBK 8x12x10	2	8	12	10	3 700	4 100
9	KBK 9x12x11.5	2.4	9	12	11.5	4 200	4 800
	KBK 9x12x13	2.75	9	12	13	4 600	5 800
	KBK 9x12x14	3.5	9	12	14	4 700	5 900
	KBK 9x13x12	4.1	9	13	12	5 300	5 700
	KBK 9x13x12.5	4.9	9	13	12.5	5 300	5 700
	KBK 9x13x13	5.1	9	13	13	5 350	5 600
10	KBK 10x13x8	2	10	13	8	4 000	5 000
	KBK 10x13x10	2.4	10	13	10	4 200	5 200
	KBK 10x13x14.5	5.1	10	13	14.5	5 400	6 600
	KBK 10x13x16	5.7	10	13	16	6 800	7 700
	KBK 10x14x10	3.4	10	14	10	4 400	4 600
	KBK 10x14x11	4	10	14	11	5 200	5 700
	KBK 10x14x12	4.5	10	14	12	5 400	6 000
	KBK 10x14x12.5	4.85	10	14	12.5	5 600	6 200
11	KBK 10x14x13	5.4	10	14	13	5 600	6 200
	KBK 11x15x17	5	11	15	17	5 200	7 000
12	KBK 12x15x13	4.6	12	15	13	5 500	7 300
	KBK 12x15x14.3	5.4	12	15	14.3	5 800	7 700
	KBK 12x15x15	5.6	12	15	15	5 900	7 800
	KBK 12x15x16.6	6.2	12	15	16.6	6 800	9 900
	KBK 12x15x17	6.3	12	15	17	7 000	10 000
	KBK 12x15x17.5	6.5	12	15	17.5	7 000	10 000
	KBK 12x16x13	6.7	12	16	13	6 300	7 600
	KBK 12x16x15	7.9	12	16	15	7 500	9 000
	KBK 12x16x15.5	8.3	12	16	15.5	7 600	10 000
	KBK 12x16x16	8.5	12	16	16	7 800	9 300
	KBK 12x16x17	9.2	12	16	17	7 900	9 400
	KBK 12x17x14	8	12	17	14	8 000	9 500
	KBK 12x17x14.3	8.4	12	17	14.3	8 000	9 500
	KBK 12x17x14.8	8.8	12	17	14.8	8 300	9 800
13	KBK 13x17x14.5	7.1	13	17	14.5	8 300	10 200
	KBK 13x17x17.5	8.6	13	17	17.5	9 500	12 100
14	KBK 14x18x10	4.6	14	18	10	6 260	7 400
	KBK 14x18x12	6.6	14	18	12	6 380	7 570
	KBK 14x18x13	7.6	14	18	13	7 300	8 700
	KBK 14x18x14	6.33	14	18	14	7 400	8 800
	KBK 14x18x14.5	8	14	18	14.5	7 400	8 800
	KBK 14x18x15	8.3	14	18	15	7 600	8 990

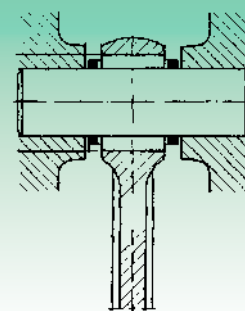
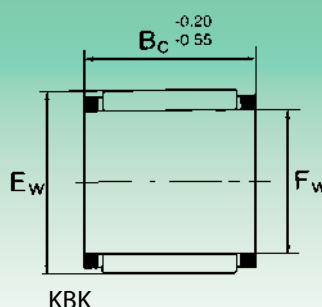
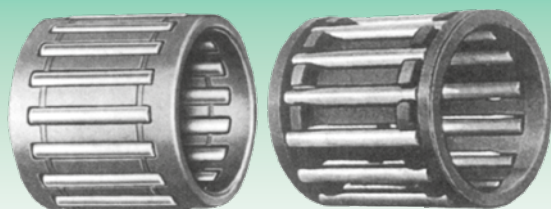
Gabbie a rullini per imbiellaggi, per supporto spinotto (serie KBK)
Needle roller and cage assemblies for piston pin of connecting rod (KBK series)

Diametro albero (mm) Shaft diameter (mm)	Sigla Designation	Peso (g) Weight (g)	Dimensioni (mm) Dimensions (mm)			Coefficienti di carico (N) Basic load ratings (N)	
			F _w	E _w	B _c	Dinamico C Dynamic C	Statico C ₀ Static C ₀
14	KBK 14x18x16.5	9.6	14	18	16.5	8 800	9 700
	KBK 14x18x17	10.1	14	18	17	9 120	11 780
	KBK 14x18x20	12	14	18	20	9 000	10 100
	KBK 14x18x21	13	14	18	21	11 875	16 530
	KBK 14x18x22	14	14	18	22	11 100	13 100
	KBK 14x19x17	10.3	14	19	17	11 100	13 100
15	KBK 15x19x10	5	15	19	10	6 500	8 600
	KBK 15x19x18	11	15	19	18	9 900	11 300
	KBK 15x19x19	12	15	19	19	10 100	12 800
	KBK 15x19x20	12.9	15	19	20	11 300	15 500
	KBK 15x20x24	18.6	15	20	24	14 100	20 000
16	KBK 16x20x19	12	16	20	19	11 700	16 800
	KBK 16x20x20	13.4	16	20	20	12 900	17 600
	KBK 16x20x21	14	16	20	21	12 900	17 600
	KBK 16x20x22	15	16	20	22	13 000	18 700
	KBK 16x21x19	16	16	21	19	13 000	18 700
17.5	KBK 17.5x22x16	9.3	17.5	22	16	11 000	16 300
18	KBK 18x22x22	16.9	18	22	22	12 825	19 665
	KBK 18x22x23.5	18	18	22	23.5	11 900	19 000
	KBK 18x22x24	18.4	18	22	24	13 395	20 900
	KBK 18x22x25	19.1	18	22	25	12 700	20 100
	KBK 18x23x21	18	18	23	21	9 900	10 100
	KBK 18x23x23	20	18	23	23	10 500	12 000
	KBK 18x24x20	20	18	24	20	20 000	25 000
20	KBK 20x24x30	22.1	20	24	30	14 900	25 500
	KBK 20x25x22	19.5	20	25	22	15 200	22 300
	KBK 20x25x25	23	20	25	25	17 100	24 000





GABBIE LINEARI PIANE A RULLINI

NEEDLE ROLLER FLAT CAGES

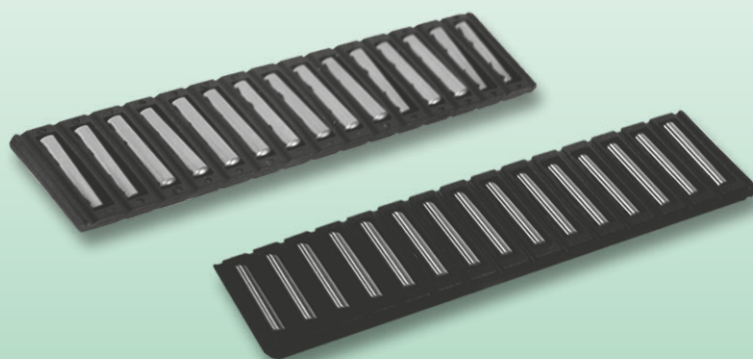



**Gabbie lineari piane a rullini****Needle roller flat cages**

Le gabbie lineari piane a rullini hanno come caratteristica principale di essere composte da numerosi corpi volventi, assicurando così il raggiungimento di altissime capacità di carico ed una notevole precisione, nonché un minimo ingombro.

Questo tipo particolare di sistema trova la sua migliore applicazione soprattutto nella costruzione di macchine che necessitano di alta precisione.

Le gabbie lineari piane a rullini, sono costituite da guide di diversa dimensione, combinate con gabbie piane. Le piste di rotolamento al fine di ottenere le prestazioni più elevate possibili, devono avere necessariamente una durezza compresa tra i 58 ed i 64 HRC. Per ciò che riguarda la precisione occorre puntualizzare che viene definita soprattutto in virtù dell'allineamento delle guide, perché se vengono perfettamente allineate e tutte costruite con la stessa lunghezza in caso di più accoppiamenti possono raggiungere ottimi risultati sia per ciò che riguarda la precisione di scorrimento che per la silenziosità, nonché sopportare dei carichi elevati grazie all'alto numero di corpi volventi.

Le gabbie lineari piane hanno un attrito uniforme e basso. Tale caratteristica permette di non incorrere nell'effetto "stick slip". Occorre ricordare comunque che il coefficiente d'attrito dipende moltissimo dalla precisione di montaggio e dalla lubrificazione.

La lubrificazione può essere eseguita sia con grasso che con olio, si consiglia di utilizzare lubrificanti con additivi.

Si può utilizzare la lubrificazione a goccia d'olio od a nebbia d'olio, particolarmente adatta in caso di ambienti polverosi; le gabbie lineari piane sono fornite già con un velo di lubrificante e non necessitano di quantità elevate di lubrificante.

Possono essere applicate delle protezioni (raschiatori) che garantiscono una buona tenuta contro eventuali agenti impuri esterni, in caso di applicazione prestare molta attenzione che i raschiatori aderiscano bene sulle piste di rotolamento per l'intera lunghezza della corsa.

Needle roller flat cages thanks to the needle rollers that form them, are able to stand very heavy loads and pressure, furthermore their dimension is really small.

Their application is particularly required for machinery requiring very high precision; needle roller flat cages are formed by guidances which are different for their dimensions, that are combined with linear cages.

Rolling grooves in order to obtain highest performances, should have an hardness included between 58 and 64 HRC.

Concerning precision, we have to point out the fact that it is determined by guides alignment: if they are perfectly lined up and have the same length, in case of multiple coupling they can reach best performances concerning precision in sliding and noise; besides thanks to their many needle roller bearings are able to stand very heavy loads.

Needle roller flat cages have an uniform and low friction, this avoids "stick slip" effect anyway we have to say that friction coefficient depends on mounting precision and lubrication.

Lubrication can be effected with oil or grease, further additives can successfully be used; "drip feed lubrication" system or "fog oil" system is particularly suitable for dusty places.

Needle roller flat cages are already prelubricated and do not need high quantity of lubricant.

Protections against external factors can be applied (oil seals): in this case the oil seals have to perfectly adhered on rolling grooves for the all length.



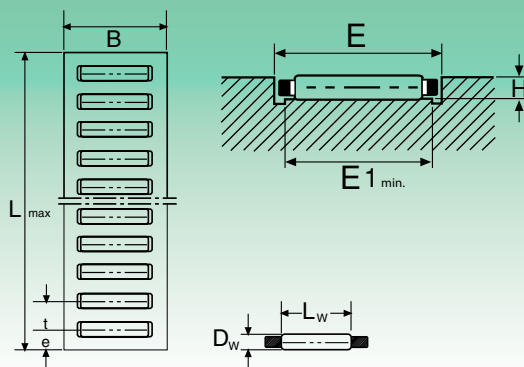
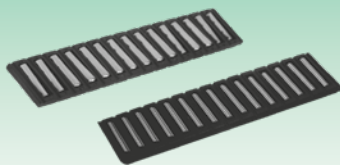

Sigla Designation	Dimensioni (mm) Dimensions (mm)							*Coefficients di carico (N) Basic Load Ratings (N)		Dimensioni di montaggio (mm) Mounting dimensions (mm)		
	B	L _{max}	D _w	t	e	L _w	Peso (g) ¹⁾ Weight (g) ¹⁾	Dinamico C _o Dynamic C _o	Statico C _o Static C _o	E	E1 _{min}	H
GLP 3020	20	2000	3	6	4.5	15.8	684	39 500	102 000	20.4 ^{+0.2}	16	2.7
GLP 5015	15	2000	5	8	5.5	11.8	750	60 000	123 000	15.3 ^{+0.2}	12	4.6
GLP 5023	23	2000	5	8	5.5	19.8	1 060	91 000	211 000	23.4 ^{+0.2}	20	4.6
GLP 5032	32	2000	5	8	5.5	27.8	1 444	119 000	300 000	32.5 ^{+0.3}	28	4.6
GLP 7028	28	2000	7	11	7.5	24	1 750	165 000	365 000	28.4 ^{+0.2}	24	6.5
GLP 7035	35	2000	7	11	7.5	30	2 160	197 000	455 000	35.6 ^{+0.3}	30	6.5
GLP 12022	22	2000	12	16	10	18	2 440	260 000	460 000	22.4 ^{+0.2}	18	11
GLP 12040	40	2000	12	16	10	36	3 940	455 000	930 000	40.5 ^{+0.2}	36	11

* I carichi si riferiscono ad una lunghezza di gabbia relativa a 10 corpi volventi.
 Loads refer to the cage length of ten rolling elements

1) Peso per L_{max} = 2000 mm
 1) Weight for L_{max} = 2000 mm



ASTUCCI A RULLINI APERTI

DRAWN CUP NEEDLE ROLLER BEARINGS OPEN END

ASTUCCI A RULLINI CON FONDELLO

DRAWN CUP NEEDLE ROLLER BEARINGS CLOSED END

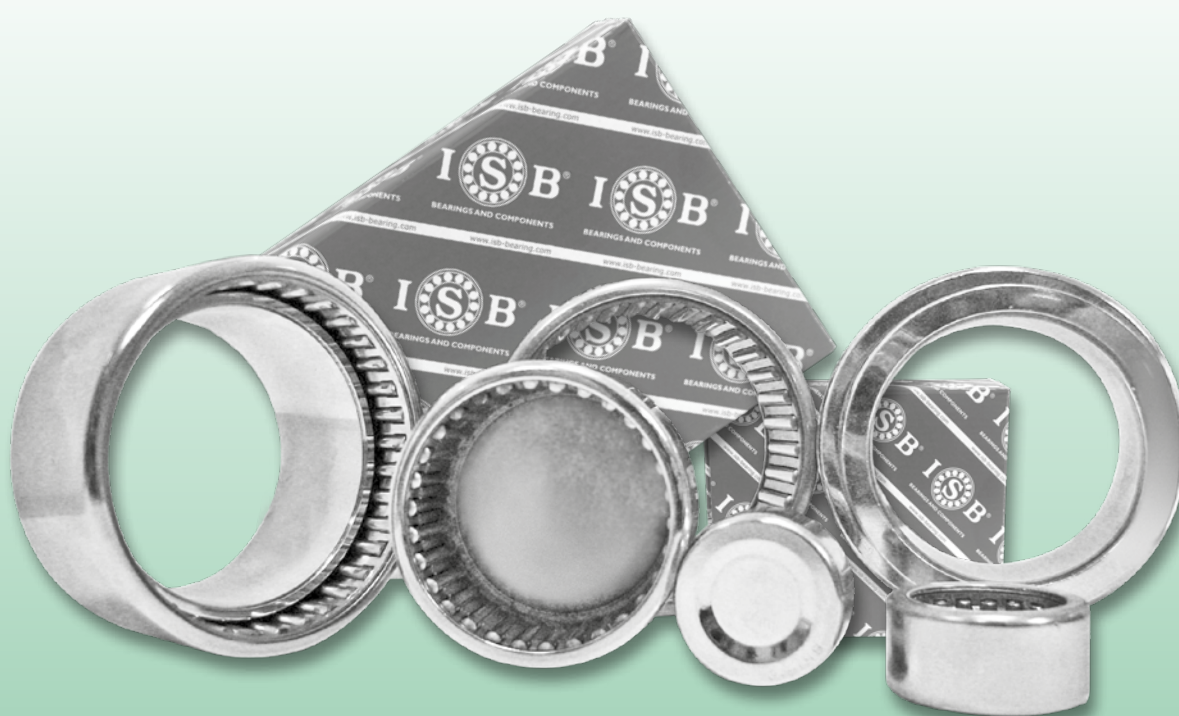



Astucci a rullini aperti - Drawn cup needle roller bearings open end

Astucci a rullini con fondello - Drawn cup needle roller bearings closed end



Gli astucci a rullini ISB senza e con fondello sono costituiti da un anello esterno molto sottile ed hanno come caratteristica principale quella di avere un ingombro molto limitato, creando così il presupposto di un conveniente montaggio ogni qualvolta si hanno spazi limitati. Gli astucci a rullini possono sopportare alti carichi ed arrivare a velocità di rotazione molto elevate, vengono montati forzandoli nel foro di alloggiamento, senza ulteriore fissaggio assiale e grazie alla gabbia i rullini vengono guidati con estrema precisione. Gli astucci a rullini possono essere montati privi di anello interno IR quindi l'albero funge da pista di rotolamento, mantenendo come presupposto che l'albero abbia una durezza compresa tra i 64 HRC e 58 HRC minimo, ottenendo così la massima capacità di carico, nel caso che si necessiti di un'applicazione con anello interno IR dovrà essere fatta precisa richiesta. Gli astucci a rullini possono essere forniti con o senza fondello, privi di lubrificante in quanto si utilizza prima del montaggio solo un conservante: generalmente si utilizzano con fondello quando si vuole chiudere l'albero da una estremità. Gli astucci a rullini su richiesta sono disponibili anche con tenute, presentano il vantaggio di una maggior protezione da agenti esterni e mantengono un potere lubrificante più elevato, anche se occorre ricordare di utilizzarli con temperature comprese tra i -30° C. e +80° C.

Tolleranze

Controllare le tolleranze degli astucci a rullini prima del loro montaggio è un'operazione abbastanza complicata, visto che per ragioni costruttive l'anello esterno può presentare leggere variazioni sulle dimensioni.

Si consiglia quindi di utilizzare degli anelli di controllo dove forzare gli astucci a rullini oppure un calibro a tampone. I valori ammessi sono specificati nella tabella seguente.

Drawn cup needle roller bearings consist of a very thin outer ring and have as a peculiar characteristic a small dimension, this enables an easy fitting up everywhere is required. HK and BK are suitable for standing heavy loads and reaching very high rotation speeds, they are forced into the housing bore and do not have to be axially fixed.

Thanks to the cage, rollers are driven with maximum precision.

Drawn cup needle roller bearings can be assembled without IR inner ring therefore the shaft works as a raceway, in this case the shaft must keep an hardness included between 64 HRC and 58 HRC maximum load ability is assured.

Under request, HK and BK can be supplied with IR inner ring. ISB needle roller bearings can be open ends or closed end, and without lubricant, in fact they are fitted with a conservative product before assembly.

BK needle roller bearings are closed at one end, they are used for shaft-end mounting.

Drawn cup needle roller bearings are also available with seals: this protects them from external factors and let them have an higher lubricating power (temperature has to be included within -30°C and +80°C).

Tolerances

Before mounting, it results a bit difficult to check drawn cup needle roller bearings tolerances, as caused by constructive reasons, outer ring can have small differences from original dimensions.

Rollers can be forced on "retaining rings" or a plug gauge can be used. For admissible value, please check the following tables.

Tipologie degli astucci a rullini - Drawn cup needle roller bearings types

Tipo-Type	Caratteristiche-Characteristics
HK, HN	Con gabbia a rullini (aperto) o a pieno riempimento di rullini <i>With needle roller and cage assembly (open end) or full complement</i>
HK..RS	Con gabbia a rullini, con tenuta ad un lato <i>With needle roller and cage assembly, sealed on one side</i>
HK..2RS	Con gabbia a rullini, con tenuta su entrambi i lati <i>With needle roller and cage assembly, sealed on both sides</i>
BK	Con gabbia a rullini, con fondello <i>With needle roller and cage assembly (closed end)</i>
BK..RS	Con gabbia a rullini, con fondello, con tenuta <i>With needle roller and cage assembly, sealed</i>
TN	Gabbia in plastica, temperatura d'esercizio ammissibile 80°C (funzionamento continuo) <i>Plastic cage, temperature allowed 80°C (continuous working)</i>

Dimensioni degli astucci a rullini Dimensions for drawn cup needle roller bearings		Anello di controllo Diametro foro Master ring Bore master	Tolleranza nominale Inscribed circle tolerance	
Diametro interno Inner diameter F _w	Diametro esterno Outer diameter D		max	min.
mm		mm		
	Cuscinetto			
3	6,5	6,484	+24	+6
4	8	7,984	+28	+10
5	9	8,984	+28	+10
6	10	9,984	+28	+10
7	11	10,980	+31	+13
8	12	11,980	+31	+13
9	13	12,980	+31	+13
10	14	13,980	+31	+13
12	16	15,980	+34	+16
12	18	17,980	+34	+16
13	19	18,976	+34	+16
14	20	19,976	+34	+16
15	21	20,976	+34	+16
16	22	21,976	+34	+16
17	23	22,976	+34	+16
18	24	23,976	+34	+16
20	26	25,976	+41	+20
22	28	27,976	+41	+20
25	32	31,972	+41	+20
28	35	34,972	+41	+20
30	37	36,972	+41	+20
35	42	41,972	+50	+25
40	47	46,972	+50	+25
45	52	51,967	+50	+25
50	58	57,967	+50	+25
55	63	62,967	+60	+30
60	68	67,967	+60	+30

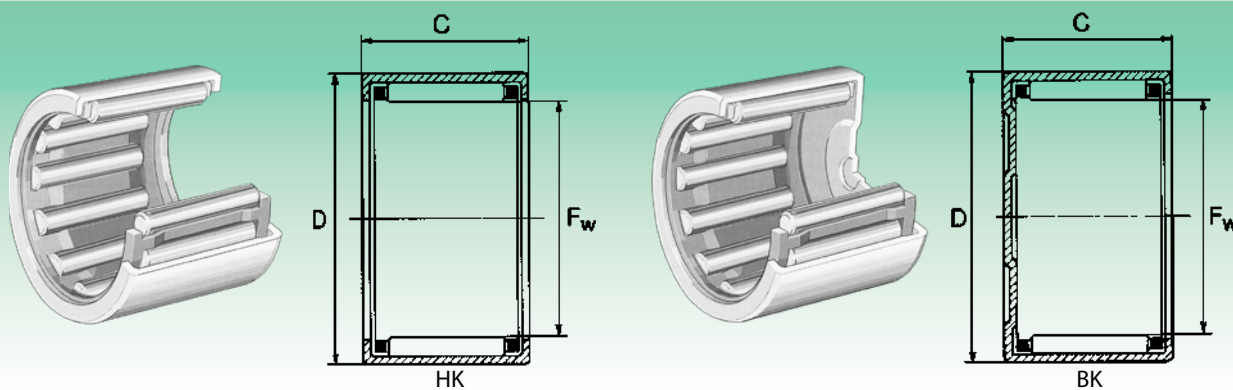

Diametro albero (mm) Shaft diameter (mm)	Sigla Designation				Dimensioni (mm) Dimensions (mm)			Coefficienti di carico (N) Basic Load Ratings (N)		Velocità limite Limiting Speed
	Astucci a rullini aperti Open end	Peso (g) Weight (g)	Astucci a rullini con fondello Closed end	Peso (g) Weight (g)	F _w	D	C	Dinamico C Dynamic C	Statico C ₀ Static C ₀	Olio (N. giri max) Oil (max rpm)
3	HK 0306 TN	1	BK 0306 TN	1	3	6.5	6	1 170	800	43 700
4	HK 0408 TN	1.6	BK 0408TN	1.8	4	8	8	1 690	1 240	39 000
5	HK 0509	2	BK 0509	2.1	5	9	9	2 280	1 890	36 000
6	HK 0606	1.8	-	-	6	10	6	2 100	1 700	34 500
	HK 0608	2.1	BK 0608	2.2	6	10	8	1 900	1 570	33 200
	HK 0609	2.2	BK 0609	2.6	6	10	9	2 700	2 470	33 200
7	HK 0709	2.3	BK 0709	2.9	7	11	9	2 950	2 800	29 400
8	HK 0808	2.7	BK 0808	3	8	12	8	2 600	2 470	26 600
	HK 0810	3	BK 0810	3.4	8	12	10	3 600	3 750	26 600
9	HK 0908	3	BK 0908	3.4	9	13	8	3 370	3 560	23 700
	HK 0910	4	BK 0910	4.3	9	13	10	4 050	4 400	23 700
	HK 0912	4.6	BK 0912	4.9	9	13	12	5 040	6 000	23 700
10	HK 1010	4.1	BK 1010	4.3	10	14	10	4 180	4 850	21 850
	HK 1012	4.8	BK 1012	5	10	14	12	5 200	6 450	21 850
	HK 1015	6	BK 1015	6.2	10	14	15	6 450	8 350	21 850
12	HK 1210	4.6	BK 1210	5.2	12	16	10	4 700	5 900	19 000
	HK 1212	9	BK 1212	10	12	18	12	6 150	6 900	18 000
13	HK 1311	8.5	-	-	13	19	11	6 300	6 300	14 000
	HK 1312	8.9	BK 1312	11.2	13	19	12	6 450	7 500	17 000
14	HK 1412	10.5	BK 1412	12	14	20	12	6 800	8 000	15 200
15	HK 1512	11.1	BK 1512	12.7	15	21	12	7 500	8 950	15 200
	HK 1516	15	BK 1516	16.5	15	21	16	9 950	13 700	15 200
	HK 1522 - ZW	20.4	BK 1522	22	15	21	22	12 700	18 500	15 200
16	HK 1612	11.7	BK 1612	13.8	16	22	12	7 200	9 200	14 200
	HK 1616	15.8	BK 1616	17.6	16	22	16	10 300	14 500	14 200
	HK 1622 - ZW	21.7	BK 1622	23.4	16	22	22	12 450	18 400	14 200
17	HK 1712	12.2	BK 1712	14.5	17	23	12	7 500	9 750	13 300
	HK 1718	19	-	-	17	23	18	9 500	10 600	10 000
18	HK 1812	13.1	BK 1812	14.9	18	24	12	7 700	10 350	12 350
	HK 1816	17.5	BK 1816	19.9	18	24	16	11 000	16 400	12 350
20	HK 2010	11.8	BK 2010	14	20	26	10	6 100	7 800	11 400
	HK 2012	14.1	BK 2012	16.7	20	26	12	8 200	11 500	11 400
	HK 2016	19.3	BK 2016	22.3	20	26	16	12 000	19 100	11 400
	HK 2020	24.1	BK 2020	27.1	20	26	20	14 900	24 700	11 400
	HK 2030 - ZW	34.7	BK 2030	37.4	20	26	30	20 700	38 000	11 400

Astucci a rullini aperti (serie HK) - Drawn cup needle roller bearings open end (HK series)

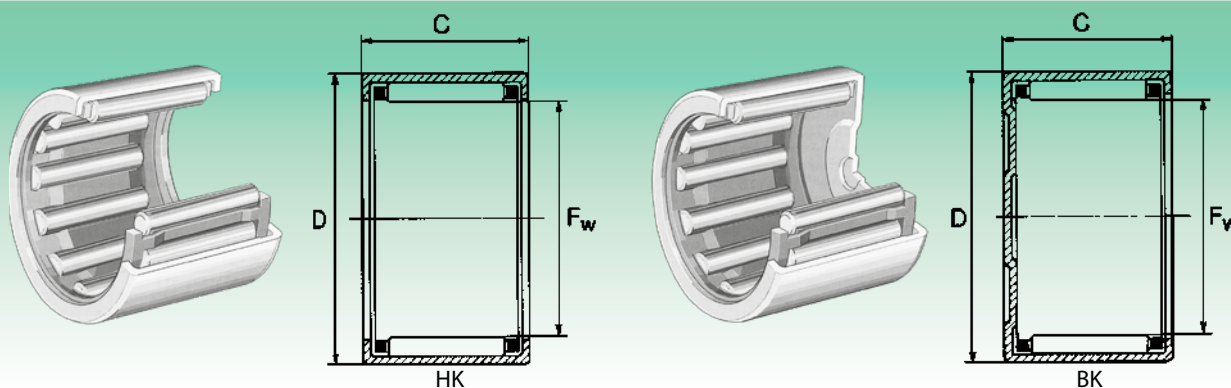
Cages à aiguilles avec fond (série BK) - Drawn cup needle roller bearings closed end (BK series)

Diametro albero (mm) Shaft diameter (mm)	Sigla Designation				Dimensioni (mm) Dimensions (mm)			Coefficienti di carico (N) Basic Load Ratings (N)		Velocità limite Limiting Speed
	Astucci a rullini aperti Open end	Peso (g) Weight (g)	Astucci a rullini con fondello Closed end	Peso (g) Weight (g)	Fw	D	C	Dinamico C Dynamic C	Statico Co Static Co	Olio (N. giri max) Oil (max rpm)
22	HK 2210	12.3	-	-	22	28	10	7 100	9 950	10 450
	HK 2212	15	BK 2212	18.1	22	28	12	8 650	12 700	10 450
	HK 2216	20.9	BK 2216	24.3	22	28	16	12 700	21 000	10 450
	HK 2220	26.2	BK 2220	29.9	22	28	20	15 650	27 550	10 450
	HK 223218	21.9	-	-	22	32	18	19 800	34 000	9 000
25	HK 2512	20	BK 2512	23.2	25	32	12	10 450	14 450	9 500
	HK 2516	27.3	BK 2516	31	25	32	16	14 800	22 800	9 500
	HK 2520	34.1	BK 2520	38.7	25	32	20	18 900	31 350	9 500
	HK 2524	-	-	-	25	32	24	-	-	-
	HK 2526	44.8	BK 2526	49	25	32	26	24 200	42 750	9 500
	HK 2538 - ZW	64.7	BK 2538	69	25	32	38	32 300	62 700	9 500
28	HK 2816	30.1	BK 2816	34.1	28	35	16	15 600	25 200	8 550
	HK 2820	37.6	BK 2820	43	28	35	20	19 850	34 200	8 550
30	HK 3012	24	BK 3012	27.9	30	37	12	11 500	17 300	8 100
	HK 3016	32	BK 3016	37.1	30	37	16	16 350	27 550	8 100
	HK 3020	40.1	BK 3020	46.5	30	37	20	20 900	37 500	8 100
	HK 3022	42	-	-	30	37	22	24 500	45 000	8 100
	HK 3026	52.9	BK 3026	59.4	30	37	26	26 600	51 300	8 100
	HK 3038 - ZW	76.1	BK 3038	82.5	30	37	38	35 600	75 000	8 100
32	HK 3220	40.6	-	-	32	39	20	22 500	42 000	7 300
	HK 3224	50.7	-	-	32	39	24	25 500	52 000	7 300
35	HK 3512	27.7	BK 3512	32.9	35	42	12	12 450	20 250	7 150
	HK 3516	36.9	BK 3516	43.8	35	42	16	17 750	31 850	6 200
	HK 3520	46.1	BK 3520	54.8	35	42	20	22 600	43 700	6 150
40	HK 4012	31.1	BK 4012	38.2	40	47	12	13 300	23 100	6 200
	HK 4016	41.4	BK 4016	51	40	47	16	19 000	36 600	6 200
	HK 4020	51.8	BK 4020	62	40	47	20	24 250	49 400	6 200
45	HK 4512	34.8	BK 4512	45	45	52	12	14 150	26 150	5 700
	HK 4516	46.2	BK 4516	56	45	52	16	20 250	40 850	5 700
	HK 4520	56	BK 4520	72	45	52	20	25 650	56 050	5 700
	HK 4538	135	-	-	45	55	38	27 600	61 000	5 300
50	HK 5012	44.2	-	-	50	58	12	23 600	57 200	5 300
	HK 5020	72	BK 5020	87.3	50	58	20	29 450	59 850	4 750
	HK 5025	90.1	BK 5025	109	50	58	25	36 550	79 800	4 750
	HK 5038	140	-	-	50	60	38	27 770	63 100	4 600
55	HK 5520	78	BK 5520	93.8	55	63	20	29 950	63 650	4 450
	HK 5528	111	BK 5528	132	55	63	28	41 800	97 850	4 080
60	HK 6012	49.2	BK 6012	77	60	68	12	16 550	30 400	4 180
	HK 6020	86	BK 6020	105	60	68	20	31 800	71 250	4 180
	HK 6032	136	BK 6032	164	60	68	32	50 350	128 250	4 180

ZW = A due corone, con foro di lubrificazione. / Double rows, with lubrication hole.

In caso di lubrificazione a grasso, è ammesso un n° di giri pari al 60% dei valori riportati in tabella.

For grease lubrication number of allowed revolution is 60% of value expressed in table (see specifications for different grease)

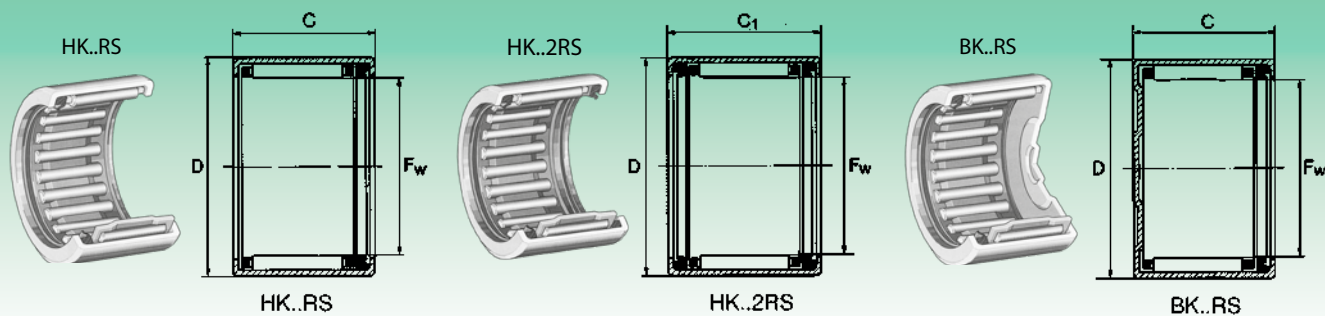

Diametro albero (mm) Shaft Diameter (mm)	Sigla Designation						Dimensioni (mm) Dimensions (mm)				Coefficienti di carico (N) Basic load ratings (N)		Velocità limite Limiting speed
	Astucci a rullini con tenuta ad un lato Open end sealed on one side	Peso Weight (g)	Astucci a rullini con tenuta da entrambi i lati Open end sealed on both side	Peso Weight (g)	Astucci a rullini con fondello e con tenute Closed end sealed on one side	Peso Weight (g)	Fw	D	C	C ₁	Dinamico C Dynamic C	Statico C ₀ Static C ₀	Grasso (N. giri max) Grease (max rpm)
8	-	-	HK 0810 2RS	-	-	-	8	12	-	10	-	-	-
	HK 0810 RS	2.9	HK 0812 2RS	3.5	-	-	8	12	10	12	2 600	2 470	19 000
	HK 0812 RS	3.1	-	-	-	-	8	12	12	-	3 500	3 400	19 000
10	-	-	HK 1012 2RS	4.3	-	-	10	14	-	12	-	-	-
	HK 1012 RS	4.2	HK 1014 2RS	5.2	-	-	10	14	12	14	4 180	4 850	16 150
12	-	-	HK1214 2RS	8	-	-	12	16	-	14	-	-	-
	HK 1214 RS	10.7	HK 1216 2RS	11.5	-	-	12	18	14	16	6 150	6 900	13 300
14	HK 1414 RS	12	HK 1416 2RS	14	BK 1414 RS	14.1	14	20	14	16	6 750	8 050	11 400
	HK 1514 RS	12.6	HK 1516 2RS	14.3	BK 1514 RS	14.4	15	21	14	16	7 400	9 300	10 450
15	HK 1518 RS	16	HK 1520 2RS	18	-	-	15	21	18	20	9 950	13 680	10 450
	HK 1614 RS	-	HK 1614 2RS	-	-	-	16	22	14	-	-	-	-
16	-	15.1	HK 1616 2RS	15.1	BK 1614 RS	15.3	16	22	14	16	7 200	9 200	10 450
	-	-	HK 1620 2RS	16.8	-	-	16	22	-	20	10 355	14 500	10 450
18	HK 1814 RS	15.1	HK 1816 2RS	17	-	-	18	24	14	16	7 700	10 350	9 000
	-	-	HK 2016 2RS	18.8	-	-	20	26	-	16	8 150	11 500	8 100
20	HK 2018 RS	21.4	HK 2020 2RS	23.5	BK 2018 RS	24.4	20	26	18	20	12 050	19 050	8 100
	HK 2214 RS	18.3	HK 2216 2RS	20.3	-	-	22	28	14	16	8 650	12 750	7 600
22	HK 2218 RS	23.5	HK 2220 2RS	25.5	-	-	22	28	18	20	12 750	21 000	7 600
	-	-	HK 2516 2RS	27.3	-	-	25	32	-	16	10 450	14 450	6 650
25	HK 2518 RS	31	HK 2520 2RS	33.1	BK 2518 RS	35.3	25	32	18	20	14 800	22 800	6 650
	-	-	HK 2524 2RS	39.7	-	-	25	32	-	24	18 900	31 350	6 650
	-	-	HK 2530 2RS	47.3	-	-	25	32	-	30	24 200	42 750	6 650
28	HK 2818 RS	-	HK 2820 2RS	36.9	-	-	28	35	18	20	15 580	25 150	5 700
	HK 3012 RS	-	HK 3016 2RS	28.5	-	-	30	37	12	16	11 500	17 300	5 700
30	HK 3018 RS	36.6	HK 3020 2RS	39.1	-	-	30	37	18	20	16 350	27 550	5 700
	-	-	HK 3024 2RS	49.7	-	-	30	37	-	24	20 900	37 500	5 700
	-	-	HK 3516 2RS	36.4	-	-	35	42	-	16	12 450	20 200	4 750
35	HK 3518 RS	37.4	HK 3520 2RS	41.1	-	-	35	42	18	20	17 750	31 800	4 750
	-	-	HK 4016 2RS	41.2	-	-	40	47	-	16	13 300	23 050	4 250
40	HK 4018 RS	47.3	HK 4020 2RS	50.2	-	-	40	47	18	20	19 000	36 550	4 250
45	HK 4518 RS	54.2	HK 4520 2RS	57.4	-	-	45	52	18	20	20 250	40 850	3 800
50	HK 5022 RS	77.2	HK 5024 2RS	84	-	-	50	58	22	24	29 450	59 850	3 450



Astucci a rullini a pieno riempimento (serie HN)

Drawn cup needle roller bearings full complement (HN series)

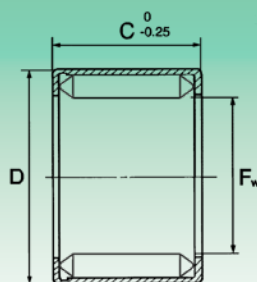

HN

Sigla Designation	Peso (g) Weight (g)	Dimensioni (mm) Dimensions (mm)				Coefficienti di carico N Basic load rating N		Carico limite di fatica Limiting fatigue load C_{ur} N	Velocità di rotazione limite Limiting rotation speed n_g grasso / n_g grease min ⁻¹	Velocità di rotazione di riferimento Reference rotation speed n_B min ⁻¹
		F_w	D	C	r min.	Dinamico Dynamic C_r	Statico Static C_{or}			
HN1010	4.6	10	14	10	0.4	7 200	11 100	1 540	10 000	13 300
HN1210	5.3	12	16	10	0.4	8 000	13 400	1 850	8 600	11 300
HN1212	10.5	12	18	12	0.8	10 200	15 200	1 950	8 000	10 800
HN1412	12	14	20	12	0.8	11 000	17 500	2 260	7 100	9 500
HN1516	14	15	21	16	0.8	15 400	27 500	3 600	6 700	8 700
HN1612	13	16	22	12	0.8	12 000	20 300	2 600	6 300	8 400
HN1816	20	18	24	16	0.8	17 000	32 500	4 250	5 700	7 500
HN2016	22	20	26	16	0.8	18 100	36 500	4 750	5 200	6 800
HN2020	29.5	20	26	20	0.8	22 400	48 000	6 600	5 200	6 700
HN2520	39.6	25	32	20	0.8	28 000	59 000	7 900	4 200	5 500
HN2820	44	28	35	20	0.8	30 000	67 000	9 000	3 800	4 950
HN3520	54	35	42	20	0.8	33 500	83 000	11 100	3 100	4 100
HN4020	60.5	40	47	20	0.8	36 000	95 000	12 700	2 750	3 650
HN4520	66	45	52	20	0.8	38 500	108 000	14 500	2 470	3 300
HN4525	85	45	52	25	0.8	47 000	139 000	19 500	2 470	3 250
HN5020	85.3	50	58	20	0.8	44 500	119 000	16 200	2 220	3 000
HN5025	107	50	58	25	0.8	54 000	152 000	21 700	2 220	2 950

Gli astucci a rullini a pieno riempimento possono essere disponibili anche in altre misure solo su richiesta specifica.
Drawn cup needle roller bearings full complement can be manufactured in other sizes, but only under specific request







CUSCINETTI A RULLINI

NEEDLE ROLLER BEARINGS





Cuscinetti a rullini Needle roller bearings



I cuscinetti a rullini ISB sono composti da corpi volventi di forma cilindrica, ed anello esterno e/o interno hanno elevata capacità di carico ed un ingombro molto limitato. I rullini vengono guidati da una gabbia rigida, che permette un controllo preciso del movimento dei rullini stessi. I rullini hanno delle tolleranze molto ridotte (2 µm.). Tutte le serie dei cuscinetti a rullini hanno un foro ed una gola di lubrificazione sull'anello esterno (i cuscinetti a rullini con grandi dimensioni possono avere più di un foro di lubrificazione).

Cuscinetti a rullini senza anello interno

I cuscinetti a rullini senza anello interno vengono impiegati direttamente sull'albero utilizzato come pista di rotolamento, chiaramente l'albero deve essere temprato e rettificato mantenendo una durezza il più possibile simile a quella dei rullini, in quanto questo permette di utilizzare al meglio il cuscinetto per ciò che riguarda il carico sopportabile, la durata nonché il numero di giri che può raggiungere.

Cuscinetti a rullini con anello interno

I cuscinetti a rullini con anello interno devono essere necessariamente utilizzati quando non è possibile sfruttare l'albero come pista di rotolamento. L'anello interno con la gabbia a rullini e l'anello esterno possono essere montati separatamente.

Cuscinetti a rullini con anelli di tenuta

I cuscinetti a rullini possono essere montati con delle tenute, che permettono una maggior protezione da agenti esterni impuri. Quando viene fornito con anelli di tenuta il cuscinetto a rullini è già ingrassato e quindi già applicabile, ma occorre non oltrepassare delle temperature che vanno da i -30°C a +80°C. Grazie alla prelubrificazione del cuscinetto si ha la possibilità di raggiungere tempi abbastanza lunghi prima di dover effettuare una nuova lubrificazione, comunque essendo il cuscinetto a rullini dotato di foro di lubrificazione non esiste alcun tipo di difficoltà per effettuare delle lubrificazioni a posteriori. I cuscinetti a rullini vengono forniti con tolleranze dimensionali di classe P0 e con giuoco normale, secondo le norme DIN. Dietro richiesta è possibile fornire cuscinetti a rullini ISB con classi di tolleranza P5 e P6 e con giuoco radiale C2 - C3 - C4.

Tipologie dei cuscinetti a rullini - Needle roller bearings types

Tipo-Type	Caratteristiche-Characteristics
NK	Senza anello interno (serie leggera) <i>Without inner ring (light series)</i>
NKS	Senza anello interno (serie pesante) <i>Without inner ring (heavy series)</i>
RNA 48/49	Senza anello interno <i>Without inner ring</i>
RNA 69 RNA 69..ZW	Ad una corona o a due corone, senza anello interno <i>With one or double row, without inner ring</i>
NKI	Con anello interno (serie leggera) <i>With inner ring (light series)</i>
NKIS	Con anello interno (serie pesante) <i>With inner ring (heavy series)</i>

ISB needle roller bearings consist of several cylindrical rollers, they have great load ability and small dimension.

Rollers are guided by a rigid cage, which enables a correct control of rollers movement: these latter have very reduced tolerances (2 µm.)

All needle roller bearings have a lubrication hole and a lubrication groove on the outer ring (bearings with big dimensions can have more than one lubrication hole)

Needle roller bearings without inner ring

Needle roller bearings without inner ring are directly mounted on the shaft using it as rolling groove, the shaft must be hardened and grinded and it has to keep the same hardness of needle rollers.

This enables to better utilise the bearings concerning load ability, number of revolutions reached and duration.

Needle roller bearings with inner ring

Needle roller bearings with inner ring are chosen when there is no possibility to use the shaft as and rolling groove. Inner ring with needle roller cage on the outer ring can be separately mounted.

Sealed needle roller bearings

Needle roller bearings can be filled with one or two seals, in order to protect them from impure external factors.

A sealed roller bearing is already prelubricated therefore ready to be assembled: temperature allowed from -30°C to +80°C.

Thanks to this prelubrication there is the possibility of reaching rather long time before repeating the operation again: anyway the roller bearing is fitted with a lubrication hole which doesn't create any difficulty to further lubrications.

Needle roller bearings have dimensional tolerances P0 and normal radial clearance, according to DIN rules.

Under request ISB needle roller bearings are supplied with P5 and P6 tolerance classes and with C2- C3-C4 radial clearance.

Tipo-Type	Caratteristiche-Characteristics
NA 48/49	Con anello interno <i>With inner ring</i>
NA 69 NA 69..ZW	Ad una corona o a due corone con anello interno <i>With one or double row, and inner ring</i>
RNA 49..RS	Con tenuta ad un lato, senza anello interno <i>With single seal, without inner ring</i>
RNA 49..2RS	Con tenute ad entrambi i lati, senza anello interno <i>Sealed on both side, without inner ring</i>
NA 49..RS	Con tenuta ad un lato, con anello interno <i>With single seal and inner ring</i>
NA 49..2RS	Con tenute ad entrambi i lati, con anello interno <i>Sealed on both side and inner ring</i>

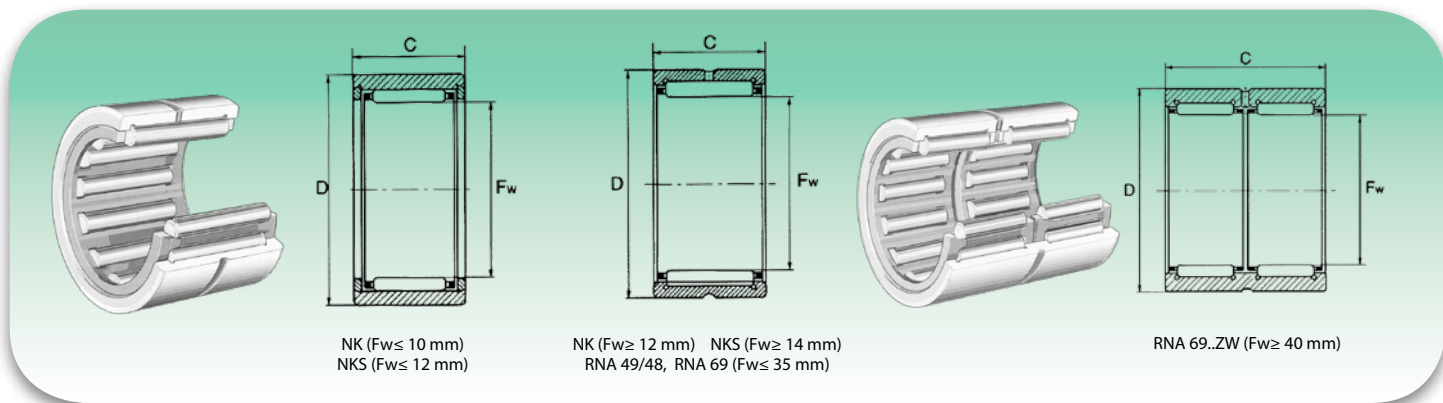

Diametro albero (mm) Shaft diameter (mm)	Sigla Designation				Peso (g) Weight (g)	Dimensioni (mm) Dimensions (mm)			Coefficienti di carico (N) Basic load ratings (N)		Velocità limite Limiting Speed Olio (N. giri max) Oil (max rpm)
	NK	NKS	RNA49/48	RNA69		Fw	D	C	Dinamico C Dynamic C	Statico C _s Static C _s	
5	• NK 5/10 TN	-	-	-	2.9	5	10	10	2 230	1 820	35 150
	• NK 5/12 TN	-	-	-	3.7	5	10	12	2 850	2 520	35 150
6	• NK 6/10 TN	-	-	-	4.7	6	12	10	2 470	2 170	31 350
	• NK 6/12 TN	-	-	-	5.7	6	12	12	3 180	2 990	31 350
7	• NK 7/10 TN	-	-	-	6.9	7	14	10	2 710	2 520	29 450
	• NK 7/12 TN	-	-	-	8.2	7	14	12	3 470	3 420	29 450
8	• NK 8/12 TN	-	-	-	8.3	8	15	12	3 750	3 900	27 550
	• NK 8/16 TN	-	-	-	12	8	15	16	4 850	5 500	27 550
	-	• NKS 8 TN	-	-	11	8	16	13	4 750	4 465	27 000
9	NK 9/12 TN	-	-	-	10.3	9	16	12	4 280	4 750	26 600
	NK 9/16 TN	-	-	-	12.8	9	16	16	5 600	6 750	26 600
10	NK 10/12 TN	-	-	-	10	10	17	12	4 550	5 230	25 650
	NK 10/16 TN	-	-	-	13.3	10	17	16	5 890	7 400	25 650
	-	• NKS 10 TN	-	-	15	10	19	13	5 500	5 700	24 000
12	NK 12/12	-	-	-	11.8	12	19	12	6 080	6 750	23 750
	NK 12/16	-	-	-	16.8	12	19	16	8 550	10 450	23 750
	-	• NKS 12 TN	-	-	23	12	22	16	9 100	9 850	22 000
14	NK 14/16	-	-	-	20.8	14	22	16	9 600	10 900	22 800
	NK 14/20	-	-	-	25.5	14	22	20	12 160	14 820	23 000
	-	NKS 14	-	-	27	14	25	16	13 600	13 000	21 850
	-	-	RNA 4900	-	24.4	14	22	13	8 060	9 000	23 750
	-	-	-	RNA 6900	29.1	14	22	22	8 281	11 612	18 322
15	NK 15/12	-	-	-	18.5	15	23	12	8 600	10 070	21 004
	NK 15/16	-	-	-	21.8	15	23	16	10 200	12 065	21 850
	NK 15/20	-	-	-	26.6	15	23	20	12 820	16 530	21 850
	-	NKS 15	-	-	30	15	26	16	13 800	13 400	21 000
16	NK 16/16	-	-	-	20.8	16	24	16	10 700	13 200	20 900
	NK 16/20	-	-	-	23.9	16	24	20	13 680	17 860	20 900
	-	-	RNA 4901	-	16.6	16	24	13	8 930	10 350	22 800
	-	-	-	RNA 6901	28.7	16	24	22	15 200	20 500	20 900
	-	NKS 16	-	-	30	16	28	16	14 900	15 000	20 000
17	NK 17/16	-	-	-	21.5	17	25	16	11 300	14 250	17 100
	NK 17/20	-	-	-	29.8	17	25	20	14 350	19 380	20 900
18	NK 18/16	-	-	-	24.9	18	26	16	11 850	15 390	19 950
	NK 18/20	-	-	-	30.5	18	26	20	15 000	20 900	19 950
	-	NKS 18	-	-	37.9	18	30	16	16 100	17 000	18 000
19	NK 19/16	-	-	-	26.1	19	27	16	12 350	16 530	19 950
	NK 19/20	-	-	-	32.2	19	27	20	15 700	22 400	19 950
20	NK 20/16	-	-	-	25.7	20	28	16	12 350	16 600	19 000
	NK 20/20	-	-	-	29.3	20	28	20	15 600	22 600	19 000
	-	NKS 20	-	-	46.8	20	32	20	21 850	23 750	18 000
	-	-	RNA 4902	-	20.5	20	28	13	10 800	12 800	20 900
-	-	-	RNA 6902	35.4	20	28	23	16 400	24 200	19 000	

• Con anelli di chiusura senza foro e gola di lubrificazione
 • Whit closing rings, without lubrication hole and groove

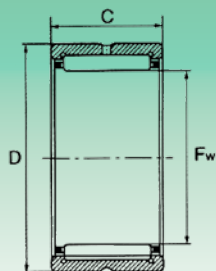
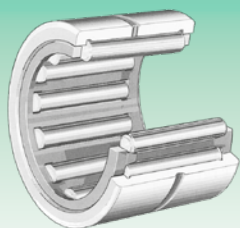
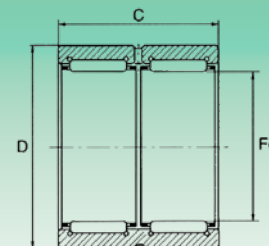
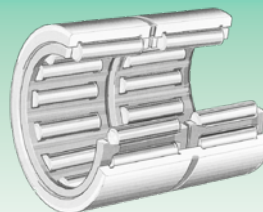
Cuscinetti a rullini senza anello interno (serie NK • NKS • RNA 49/48 • RNA 69)
Needle roller bearing without inner ring (NK • NKS • RNA 49/48 • RNA 69 series)

 NK - NKS
RNA 49/48, RNA 69

RNA 69.ZW

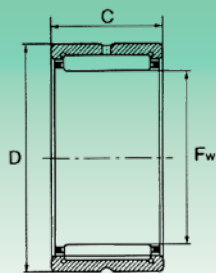
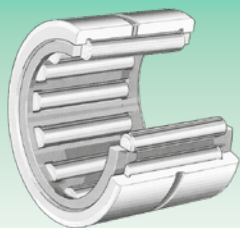
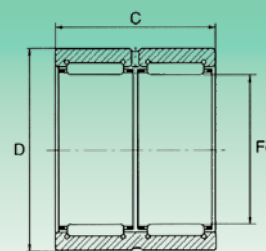
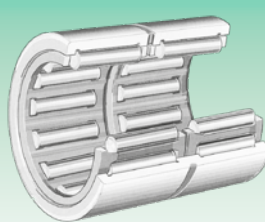
Diametro albero (mm) Shaft diameter (mm)	Sigla Designation				Peso (g) Weight (g)	Dimensioni (mm) Dimensions (mm)			Coefficienti di carico (N) Basic load ratings (N)		Velocità limite Limiting Speed Olio (N. giri max) Oil (max rpm)
	NK	NKS	RNA49/48	RNA69		Fw	D	C	Dinamico C Dynamic C	Statico C _s Static C _s	
21	NK 21/16	-	-	-	28.1	21	29	16	12 800	17 750	19 000
	NK 21/20	-	-	-	35.2	21	29	20	16 250	24 220	19 000
22	NK 22/16	-	-	-	29.2	22	30	16	13 300	18 900	18 000
	NK 22/20	-	-	-	37	22	30	20	16 800	25 650	18 000
	-	NKS 22	-	-	60.2	22	35	20	23 275	26 600	17 000
	-	-	RNA 4903	-	20.7	22	30	13	10 450	13 870	19 950
	-	-	-	RNA 6903	39.8	22	30	23	17 650	27 550	18 000
24	NK 24/16	-	-	-	31.9	24	32	16	14 250	21 200	17 000
	NK 24/20	-	-	-	40	24	32	20	18 050	29 000	17 000
	-	NKS 24	-	-	65.5	24	37	20	25 500	30 400	15 200
25	NK 25/16	-	-	-	30	25	33	16	14 150	21 280	16 150
	NK 25/20	-	-	-	38.4	25	33	20	17 860	29 000	16 150
	-	-	RNA 4904	-	50.8	25	37	17	19 950	24 200	16 150
	-	-	-	RNA 6904	97.7	25	37	30	34 200	48 450	15 200
	-	NKS 25	-	-	65	25	38	20	26 100	31 800	15 200
26	NK 26/16	-	-	-	30	26	34	16	14 550	22 400	15 200
	NK 26/20	-	-	-	40	26	34	20	18 450	30 400	15 200
28	NK 28/20	-	-	-	52.2	28	37	20	20 900	32 300	14 250
	NK 28/30	-	-	-	82	28	37	30	31 350	54 150	14 250
	-	NKS 28	-	-	80	28	42	20	27 100	34 650	13 300
	-	-	RNA 49/22	-	50.2	28	39	17	21 660	28 000	15 200
	-	-	-	RNA 69/22	98	28	39	30	37 000	54 500	13 000
29	NK 29/20	-	-	-	53.7	29	38	20	20 800	32 300	14 250
	NK 29/30	-	-	-	84.3	29	38	30	30 900	54 150	14 250
30	NK 30/20	-	-	-	57.9	30	40	20	21 470	34 200	13 300
	NK 30/30	-	-	-	95	30	40	30	31 800	57 000	13 300
	-	NKS 30	-	-	104	30	45	22	31 500	39 500	11 000
	-	-	RNA 4905	-	57	30	42	17	22 420	29 900	14 250
	-	-	-	RNA 6905	106.5	30	42	30	37 000	56 000	13 300
32	NK 32/20	-	-	-	75.4	32	42	20	21 950	35 600	12 350
	NK 32/30	-	-	-	102	32	42	30	34 000	62 500	12 350
	-	NKS 32	-	-	100	32	47	22	31 800	41 300	11 400
	-	-	RNA 49/28	-	80	32	45	17	23 180	31 800	12 350
	-	-	-	RNA 69/28	125	32	45	30	39 500	61 300	13 000
35	NK 35/20	-	-	-	70	35	45	20	23 000	39 400	11 400
	NK 35/30	-	-	-	112	35	45	30	36 000	68 500	11 400
	-	NKS 35	-	-	118	35	50	22	34 500	46 500	10 000
	-	-	RNA 4906	-	62.8	35	47	17	23 750	33 700	12 350
	-	-	-	RNA 6906	116	35	47	30	41 300	67 450	11 400
37	NK 37/20	-	-	-	77	37	47	20	24 300	43 000	11 400
	NK 37/30	-	-	-	113	37	47	30	36 300	72 500	11 400
	-	NKS 37	-	-	123	37	52	22	34 700	47 500	10 450

 NK - NKS
RNA 49/48, RNA 69

RNA 69..ZW

Diametro albero (mm) Shaft diameter (mm)	Sigla Designation				Peso (g) Weight (g)	Dimensioni (mm) Dimensions (mm)			Coefficienti di carico (N) Basic load ratings (N)		Velocità limite Limiting Speed Olio (N. giri max) Oil (max rpm)
	NK	NKS	RNA49/48	RNA69		Fw	D	C	Dinamico C Dynamic C	Statico C _s Static C _s	
38	NK 38/20	-	-	-	79.4	38	48	20	25 000	44 500	10 450
	NK 38/30	-	-	-	116	38	48	30	37 000	75 000	10 450
40	NK 40/20	-	-	-	78.9	40	50	20	24 700	44 650	10 450
	NK 40/30	-	-	-	120	40	50	30	37 000	75 000	10 450
	-	NKS 40	-	-	129	40	55	22	37 200	53 500	8 500
	-	-	RNA 49/32	-	89.1	40	52	20	30 000	46 800	10 500
	-	-	-	RNA 69/32 - ZW	147	40	52	36	44 650	77 900	10 450
42	NK 42/20	-	-	-	83	42	52	20	25 200	46 550	9 500
	NK 42/30	-	-	-	125	42	52	30	37 500	77 900	9 500
	-	-	RNA 4907	-	99.3	42	55	20	29 900	47 500	10 450
	-	-	-	RNA 6907 - ZW	193	42	55	36	45 600	81 700	9 500
43	NK 43/20	-	-	-	84	43	53	20	25 700	49 000	9 500
	NK 43/30	-	-	-	126	43	53	30	38 500	80 750	9 500
	-	NKS 43	-	-	139	43	58	22	37 000	54 150	9 000
45	NK 45/20	-	-	-	91	45	55	20	26 100	50 350	9 500
	NK 45/30	-	-	-	139	45	55	30	40 000	87 000	9 500
	-	NKS 45	-	-	145	45	60	22	38 500	57 000	9 000
47	NK 47/20	-	-	-	94.5	47	57	20	28 000	55 000	9 000
	NK 47/30	-	-	-	142	47	57	30	42 500	93 500	9 000
48	-	-	RNA 4908	-	132	48	62	22	40 850	63 650	9 000
	-	-	-	RNA 6908 - ZW	255	48	62	40	64 000	112 000	8 120
50	NK 50/25	-	-	-	167	50	62	25	36 100	70 300	8 550
	NK 50/35	-	-	-	236	50	62	35	47 500	100 700	8 550
	-	NKS 50	-	-	157	50	65	22	41 800	66 500	7 000
52	-	-	RNA 4909	-	182	52	68	22	42 750	69 350	8 100
	-	-	-	RNA 6909 - ZW	338	52	68	40	65 500	120 650	7 600
55	NK 55/25	-	-	-	167	55	68	25	38 000	77 900	7 600
	NK 55/35	-	-	-	250	55	68	35	52 500	117 000	7 600
	-	NKS 55	-	-	221	55	72	22	44 000	73 000	6 000
58	-	-	RNA 4910	-	161	58	72	22	44 650	76 000	7 600
	-	-	-	RNA 6910 - ZW	296	58	72	40	69 400	132 000	7 200
60	NK 60/25	-	-	-	185	60	72	25	39 900	85 500	7 100
	NK 60/35	-	-	-	258	60	72	35	55 000	130 000	7 100
	-	NKS 60	-	-	335	60	80	28	62 500	97 500	6 000
63	-	-	RNA 4911	-	241	63	80	25	55 100	95 000	7 100
	-	-	-	RNA 6911 - ZW	470	63	80	45	85 500	167 200	6 650
65	NK 65/25	-	-	-	221	65	78	25	43 500	97 000	6 650
	NK 65/35	-	-	-	310	65	78	35	58 200	141 300	6 650
	-	NKS 65	-	-	356	65	85	28	65 800	106 700	6 100
68	NK 68/25	-	-	-	241	68	82	25	43 000	88 000	6 100
	NK 68/35	-	-	-	338	68	82	35	61 000	138 000	6 100
	-	-	RNA 4912	-	275	68	85	25	57 000	102 600	6 600
	-	-	-	RNA 6912 - ZW	488	68	85	45	89 300	181 450	6 200
70	NK 70/25	-	-	-	260	70	85	25	44 000	91 000	6 100
	NK 70/35	-	-	-	370	70	85	35	62 000	143 000	6 100
	-	NKS 70	-	-	380	70	90	28	66 500	112 000	4 500

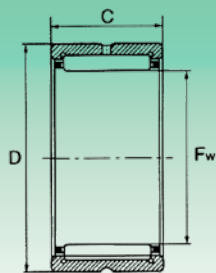
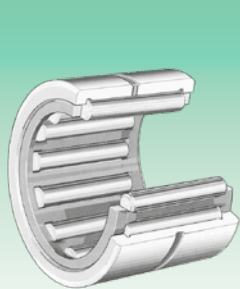
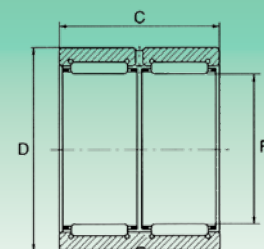
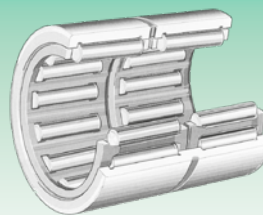
Cuscinetti a rullini senza anello interno (serie NK • NKS • RNA 49/48 • RNA 69)
Needle roller bearing without inner ring (NK • NKS • RNA 49/48 • RNA 69 series)

 NK - NKS
RNA 49/48

RNA 69.ZW

Diametro albero (mm) Shaft diameter (mm)	Sigla Designation				Peso (g) Weight (g)	Dimensioni (mm) Dimensions (mm)			Coefficienti di carico (N) Basic load ratings (N)		Velocità limite Limiting Speed Olio (N. giri max) Oil (max rpm)
	NK	NKS	RNA49/48	RNA69		Fw	D	C	Dinamico C Dynamic C	Statico C _s Static C _s	
72	-	-	RNA 4913	-	300	72	90	25	57 500	110 500	6 100
	-	-	-	RNA 6913 - ZW	571	72	90	45	90 250	188 100	6 000
73	NK 73/25	-	-	-	302	73	90	25	51 500	99 000	5 700
	NK 73/35	-	-	-	428	73	90	35	74 000	155 000	5 700
75	NK 75/25	-	-	-	315	75	92	25	53 500	103 000	5 700
	NK 75/35	-	-	-	445	75	92	35	76 000	161 000	5 700
	-	NKS 75	-	-	402	75	95	28	70 000	122 000	5 700
80	NK 80/25	-	-	-	301	80	95	25	55 500	118 000	5 200
	NK 80/35	-	-	-	425	80	95	35	77 000	183 000	5 200
	-	NKS 80	-	-	413	80	100	28	74 500	132 000	4 000
	-	-	RNA 4914	-	460	80	100	30	79 800	148 200	5 700
	-	-	-	RNA 6914 - ZW	857	80	100	54	121 000	263 000	5 130
85	NK 85/25	-	-	-	425	85	105	25	68 000	122 000	4 750
	NK 85/35	-	-	-	600	85	105	35	97 000	192 000	4 750
	-	-	RNA 4915	-	472	85	105	30	82 000	158 000	5 130
	-	-	-	RNA 6915 - ZW	923	85	105	54	128 000	272 000	5 130
90	NK 90/25	-	-	-	450	90	110	25	70 500	130 000	4 600
	NK 90/35	-	-	-	630	90	110	35	102 000	205 500	4 600
	-	-	RNA 4916	-	516	90	110	30	84 550	170 500	4 927
	-	-	-	RNA 6916 - ZW	978	90	110	54	128 250	285 000	4 650
95	NK 95/26	-	-	-	490	95	115	26	71 000	136 000	4 450
	NK 95/36	-	-	-	680	95	115	36	105 000	221 000	4 450
100	NK 100/26	-	-	-	515	100	120	26	75 000	145 000	4 200
	NK 100/36	-	-	-	715	100	120	36	110 000	236 000	4 200
	-	-	RNA 4917	-	657	100	120	35	105 450	225 150	4 600
	-	-	-	RNA 6917 - ZW	1 200	100	120	63	157 700	380 000	4 300
105	NK 105/26	-	-	-	540	105	125	26	76 500	153 000	4 085
	NK 105/36	-	-	-	713	105	125	36	112 000	248 000	4 085
	-	-	RNA 4918	-	745	105	125	35	108 300	237 500	4 370
	-	-	-	RNA 6918 - ZW	1 330	105	125	63	165 000	403 750	4 100
110	NK 110/30	-	-	-	650	110	130	30	96 000	209 000	3 900
	NK 110/40	-	-	-	830	110	130	40	125 000	287 000	3 900
	-	-	RNA 4919	-	719	110	130	35	112 000	245 000	4 180
	-	-	-	RNA 6919 - ZW	1 460	110	130	63	196 000	418 000	3 900
115	-	NKS 115	-	-	700	115	135	32	90 000	202 000	3 705
	-	-	RNA 4920	-	1 006	115	140	40	120 000	264 000	3 895
120	NK 120/40	-	-	-	910	120	140	40	112 000	274 000	3 600
	-	-	RNA 4822	-	670	120	140	30	93 000	215 000	3 600
125	-	-	RNA 4922	-	1 200	125	150	40	125 400	275 500	3 600
130	-	-	RNA 4824	-	730	130	150	30	91 600	234 000	3 325
135	-	-	RNA 4924	-	1 760	135	165	45	174 000	386 000	3 230
145	-	-	RNA 4826	-	990	145	165	35	117 000	300 000	3 040
150	-	-	RNA 4926	-	2 210	150	180	50	201 000	450 000	3 040
155	NK 155/32	-	-	-	1 200	155	180	32	112 000	250 000	2 755
	-	-	RNA 4828	-	988	155	175	35	119 000	321 000	2 850



Cuscinetti a rullini senza anello interno (serie NK • NKS • RNA 49/48 • RNA 69)

Needle roller bearing without inner ring (NK • NKS • RNA 49/48 • RNA 69 series)

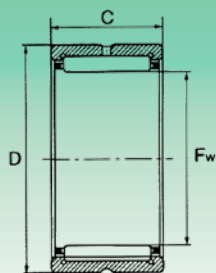
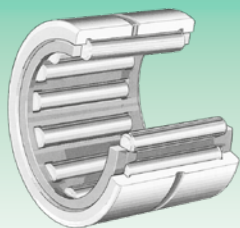

RNA 49/48

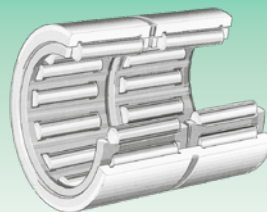

RNA 69..ZW

Diametro albero (mm) Shaft diameter (mm)	Sigla Designation				Peso (g) Weight (g)	Dimensioni (mm) Dimensions (mm)			Coefficienti di carico (N) Basic load ratings (N)		Velocità limite Limiting Speed Olio (N. giri max) Oil (max rpm)
	NK	NKS	RNA49/48	RNA69		Fw	D	C	Dinamico C Dynamic C	Statico C _s Static C _s	
160	-	-	RNA 4928	-	2 350	160	190	50	200 000	460 000	2 900
165	-	-	RNA 4830	-	1 600	165	190	40	150 000	380 000	2 660
175	-	-	RNA 4832	-	1 700	175	200	40	152 000	425 000	2 470
185	-	-	RNA 4834	-	2 540	185	215	45	183 000	500 000	2 375
195	-	-	RNA 4836	-	2 680	195	225	45	193 500	540 000	2 100
210	-	-	RNA 4838	-	3 210	210	240	50	226 000	680 000	2 000
220	-	-	RNA 4840	-	3 350	220	250	50	215 000	700 000	1 995
240	-	-	RNA 4844	-	3 620	240	270	50	240 000	770 000	1 805
265	-	-	RNA 4848	-	5 400	265	300	60	345 000	1 070 000	1 600
285	-	-	RNA 4852	-	5 800	285	320	60	365 000	1 150 000	1 500
305	-	-	RNA 4856	-	9 300	305	350	69	440 000	1 200 000	1 425
330	-	-	RNA 4860	-	12 700	330	380	80	610 000	1 570 000	1 300
350	-	-	RNA 4864	-	13 400	350	400	80	615 000	1 800 000	1 200
370	-	-	RNA 4868	-	14 000	370	420	80	620 000	1 900 000	1 140
390	-	-	RNA 4872	-	14 800	390	440	80	640 000	2 000 000	1 140
415	-	-	RNA 4876	-	26 000	415	480	100	950 000	2 755 000	1 045

TN = Gabbia in plastica, temperatura d'esercizio ammissibile: 80°C (per funzionamento continuo).

TN = Plastic cage; temperature allowed: 80° (continuous working)

Da Ø 160 a Ø 415 solo su richiesta.

From Ø 160 to Ø 415 available under request.

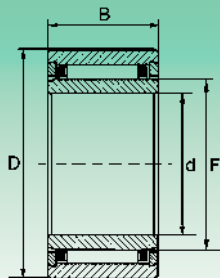
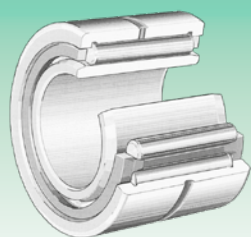

Cuscinetti a rullini con anello interno (serie NKI • NKIS • NA 49/48 • NA 69)
Needle roller bearing with inner ring (NKI • NKIS • NA 49/48 • NA 69 series)

NKI, NKIS (d ≤ 7 mm)

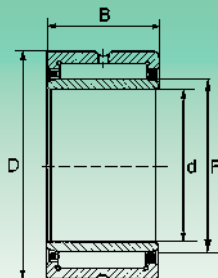
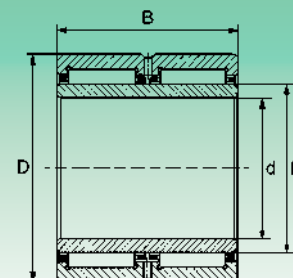
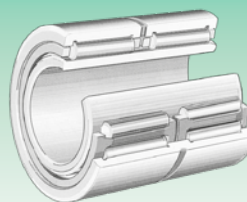

 NKI (d ≥ 9 mm) NKIS (d ≥ 8 mm)
 NA 49/48 NA 69 (d ≤ 30 mm)

NA 69..ZW (d ≥ 32 mm)

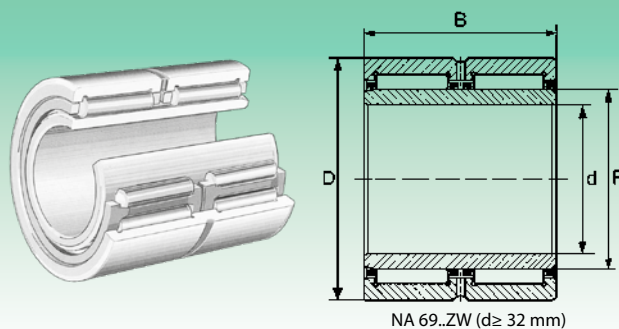
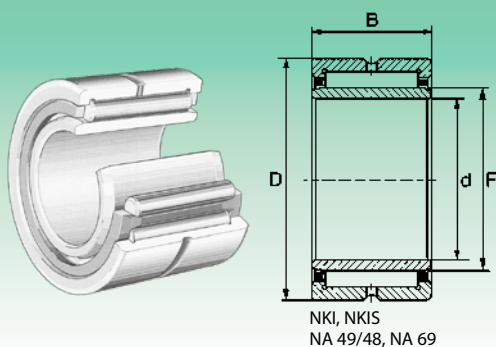
Diametro albero (mm) Shaft diameter (mm)	Sigla Designation				Peso (g) Weight (g)	Dimensioni (mm) Dimensions (mm)				Coefficienti di carico (N) Basic load ratings (N)		Velocità limite Limiting Speed
	NKI	NKIS	NA 49/48	NA 69		d	F	D	B	Dinamico C Dynamic C	Statico C _s Static C _s	Olio (N. giri max) Oil (max rpm)
5	* NKI 5/12 TN *	-	-	-	11.5	5	8	15	12	3 750	3 900	30 400
	NKI 5/16 TN	-	-	-	15.3	5	8	15	16	4 900	5 700	30 400
6	* NKI 6/12 TN	-	-	-	13.5	6	9	16	12	4 270	4 750	28 500
	* NKI 6/16 TN	-	-	-	17.4	6	9	16	16	5 600	6 750	28 500
	-	⁴ NKIS 6 TN	-	-	19.9	6	10	19	13	5 510	5 700	26 000
7	* NKI 7/12 TN	-	-	-	13.7	7	10	17	12	4 500	5 200	27 500
	* NKI 7/16 TN	-	-	-	18.2	7	10	17	16	5 900	7 400	27 500
	-	⁴ NKIS 7 TN	-	-	34.6	7	12	22	16	9 100	9 800	24 000
8	-	NKIS 8	-	-	46	8	14	25	16	13 680	13 110	21 500
9	NKI 9/12	-	-	-	14.6	9	12	19	12	6 200	7 002	25 000
	NKI 9/16	-	-	-	21.9	9	12	19	16	8 500	10 500	25 000
	-	⁴ NKIS 9	-	-	41.4	9	15	26	16	13 800	13 500	22 000
10	NKI 10/16	-	-	-	27.3	10	14	22	16	9 808	10 500	23 500
	NKI 10/20	-	-	-	37.1	10	14	22	20	12 150	14 800	23 500
	-	⁴ NKIS 10	-	-	54	10	16	28	16	15 000	15 100	21 000
	-	-	NA 4900	-	21	10	14	22	13	8 006	9 000	23 700
	-	-	-	NA 6900	38.4	10	14	22	22	8 281	11 612	23 700
12	NKI 12/16	-	-	-	33.3	12	16	24	16	10 800	13 100	22 800
	NKI 12/20	-	-	-	39	12	16	24	20	14 000	18 400	22 800
	-	-	NA 4901	-	25.1	12	16	24	13	8 900	10 300	22 800
	-	-	-	NA 6901	44.5	12	16	24	22	15 200	20 500	22 800
	-	-	NKIS 12	-	58	12	18	30	16	16 000	17 000	20 000
15	NKI 15/16	-	-	-	38	15	19	27	16	12 350	16 530	20 900
	NKI 15/20	-	-	-	45.7	15	19	27	20	15 650	22 400	20 900
	-	-	NA 4902	-	32	15	20	28	13	10 050	12 900	20 900
	-	-	-	NA 6902	61.6	15	20	28	23	16 400	24 200	20 900
	-	-	NKIS 15	-	90	15	22	35	20	23 500	26 600	19 000
17	NKI 17/16	-	-	-	41.4	17	21	29	16	13 000	18 200	20 000
	NKI 17/20	-	-	-	53.4	17	21	29	20	16 500	24 900	20 000
	-	-	NA 4903	-	32.8	17	22	30	13	10 450	13 850	19 900
	-	-	-	NA 6903	68.2	17	22	30	23	17 650	27 550	19 900
	-	-	NKIS 17	-	98	17	24	37	20	25 000	30 000	17 000
20	NKI 20/16	-	-	-	48.5	20	24	32	16	14 250	21 150	18 050
	NKI 20/20	-	-	-	61	20	24	32	20	18 000	29 500	18 050
	-	-	NA 4904	-	70.2	20	25	37	17	19 950	24 200	16 200
	-	-	-	NA 6904	141	20	25	37	30	33 000	51 000	16 000
	-	-	NKIS 20	-	119	20	28	42	20	26 500	35 500	14 000
22	NKI 22/16	-	-	-	50	22	26	34	16	14 500	22 400	17 000
	NKI 22/20	-	-	-	65.4	22	26	34	20	18 700	31 000	17 000
	-	-	NA 49/22	-	76	22	28	39	17	21 650	28 000	15 200
	-	-	-	NA 69/22	130	22	28	39	30	35 600	52 250	15 200
25	NKI 25/20	-	-	-	79.4	25	29	38	20	21 000	33 000	15 200
	NKI 25/30	-	-	-	115	25	29	38	30	31 500	56 000	14 000
	-	-	NA 4905	-	76	25	30	42	17	22 400	29 900	14 250
	-	-	-	NA 6905	160	25	30	42	30	37 000	56 000	14 250
	-	-	NKIS 25	-	160	25	32	47	22	32 000	41 300	12 500

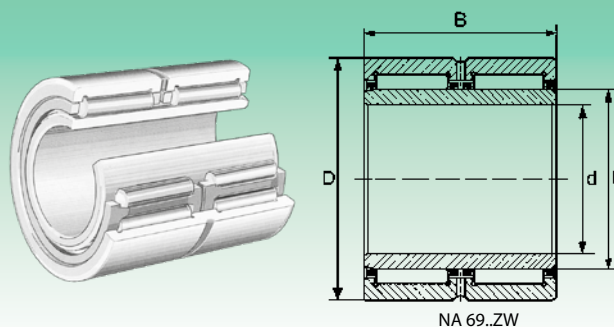
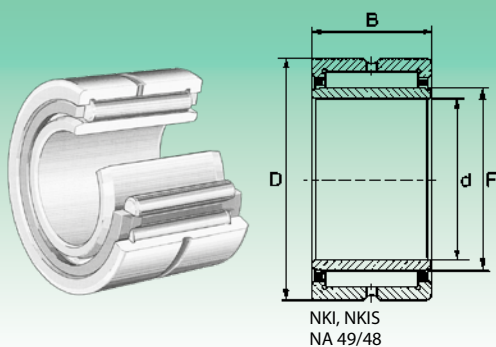

Diametro albero (mm) Shaft diameter (mm)	Sigla Designation				Peso (g) Weight (g)	Dimensioni (mm) Dimensions (mm)				Coefficienti di carico (N) Basic load ratings (N)		Velocità limite Limiting Speed Olio (N. giri max) Oil (max rpm)
	NKI	NKIS	NA 49/48	NA 69		d	F	D	B	Dinamico C Dynamic C	Statico C _s Static C _s	
28	NKI 28/20	-	-	-	96.5	28	32	42	20	22 700	36 500	13 300
	NKI 28/30	-	-	-	146	28	32	42	30	34 000	61 000	13 300
	-	-	NA 49/28	-	90.7	28	32	45	17	23 200	31 800	12 350
	-	-	-	NA 69/28	170	28	32	45	30	38 400	59 800	12 350
30	NKI 30/20	-	-	-	112	30	35	45	20	23 500	41 000	12 350
	NKI 30/30	-	-	-	170	30	35	45	30	36 000	68 000	12 350
	-	-	NA 4906	-	101	30	35	47	17	23 000	34 000	12 350
	-	-	-	NA 6906	192	30	35	47	30	42 500	70 500	12 350
	-	NKIS 30	-	-	184	30	37	52	22	35 000	48 000	12 350
32	NKI 32/20	-	-	-	101	32	37	47	20	23 650	41 300	11 400
	NKI 32/30	-	-	-	180	32	37	47	30	36 500	71 500	11 400
	-	-	NA 49/32	-	150	32	40	52	20	28 950	45 100	11 400
	-	-	-	NA 69/32 - ZW	272	32	40	52	36	44 650	77 900	11 400
35	NKI 35/20	-	-	-	127	35	40	50	20	25 000	45 000	11 400
	NKI 35/30	-	-	-	193	35	40	50	30	37 000	75 000	11 400
	-	-	NA 4907	-	151	35	42	55	20	29 900	47 500	10 450
	-	-	-	NA 6907 - ZW	301	35	42	55	36	45 600	81 700	10 450
	-	NKIS 35	-	-	210	35	43	58	22	37 000	56 000	10 450
38	NKI 38/20	-	-	-	136	38	43	53	20	25 000	49 000	10 450
	NKI 38/30	-	-	-	207	38	43	53	30	40 000	84 000	10 450
40	NKI 40/20	-	-	-	142	40	45	55	20	26 100	50 350	9 500
	NKI 40/30	-	-	-	216	40	45	55	30	35 000	86 000	9 500
	-	-	NA 4908	-	230	40	48	62	22	40 850	63 650	9 000
	-	-	-	NA 6908 - ZW	430	40	48	62	40	64 000	112 000	9 000
	-	NKIS 40	-	-	281	40	50	65	22	41 000	65 000	9 000
42	NKI 42/20	-	-	-	138	42	47	57	20	26 000	52 500	9 500
	NKI 42/30	-	-	-	222	42	47	57	30	41 000	92 000	9 500
45	NKI 45/25	-	-	-	218	45	50	62	25	36 000	70 000	8 550
	NKI 45/35	-	-	-	322	45	50	62	35	47 500	100 700	8 550
	-	-	NA 4909	-	260	45	52	68	22	42 750	69 350	8 075
	-	-	-	NA 6909 - ZW	479	45	52	68	40	65 550	120 650	8 075
	-	NKIS 45	-	-	336	45	55	72	22	43 000	71 000	8 075
50	NKI 50/25	-	-	-	262	50	55	68	25	38 000	78 000	8 075
	NKI 50/35	-	-	-	379	50	55	68	35	52 500	117 000	8 075
	-	-	NA 4910	-	264	50	58	72	22	44 650	76 000	7 600
	-	-	-	NA 6910 - ZW	515	50	58	72	40	69 350	132 000	7 600
	-	NKIS 50	-	-	510	50	60	80	28	60 000	95 000	7 200
55	NKI 55/25	-	-	-	272	55	60	72	25	41 000	88 000	7 100
	NKI 55/35	-	-	-	357	55	60	72	35	48 000	126 000	7 100
	-	-	NA 4911	-	386	55	63	80	25	55 100	95 000	7 100
	-	-	-	NA 6911 - ZW	760	55	63	80	45	82 560	172 000	7 156
	-	NKIS 55	-	-	558	55	65	85	28	65 500	107 000	7 100

Cuscinetti a rullini con anello interno (serie NKI • NKIS • NA 49/48 • NA 69)
Needle roller bearing with inner ring (NKI • NKIS • NA 49/48 • NA 69 series)

Diametro albero (mm) Shaft diameter (mm)	Sigla Designation				Peso (g) Weight (g)	Dimensioni (mm) Dimensions (mm)				Coefficienti di carico (N) Basic load ratings (N)		Velocità limite Limiting Speed
	NKI	NKIS	NA49/48	NA69		d	F	D	B	Dinamico C Dynamic C	Statico C _s Static C _s	Olio (N. giri max) Oil (max rpm)
60	NKI 60/25	-	-	-	388	60	68	82	25	41 300	84 550	6 700
	NKI 60/35	-	-	-	553	60	68	82	35	60 000	137 000	6 700
	-	-	NA 4912	-	412	60	68	85	25	57 000	102 600	6 700
	-	-	-	NA 6912 - ZW	798	60	68	85	45	88 500	186 000	6 700
	-	NKIS 60	-	-	550	60	70	90	28	65 000	110 000	6 200
65	NKI 65/25	-	-	-	467	65	73	90	25	51 000	99 000	6 200
	NKI 65/35	-	-	-	659	65	73	90	35	73 000	154 000	6 200
	-	-	NA 4913	-	456	65	72	90	25	57 500	110 500	6 200
	-	-	-	NA 6913 - ZW	821	65	72	90	45	87 600	194 500	5 700
	-	NKIS 65	-	-	641	65	75	95	28	69 000	121 000	6 200
70	NKI 70/25	-	-	-	521	70	80	95	25	55 000	117 000	5 700
	NKI 70/35	-	-	-	737	70	80	95	35	77 000	182 000	5 700
	-	-	NA 4914	-	712	70	80	100	30	79 000	154 000	5 700
	-	-	-	NA 6914 - ZW	1 326	70	80	100	54	121 000	263 000	5 700
	-	NKIS 70	-	-	680	70	80	100	28	73 000	131 500	5 700
75	NKI 75/25	-	-	-	641	75	85	105	25	68 000	121 000	5 200
	NKI 75/35	-	-	-	908	75	85	105	35	97 000	192 000	5 200
	-	-	NA 4915	-	765	75	85	105	30	82 000	158 000	5 200
	-	-	-	NA 6915 - ZW	1 429	75	85	105	54	128 000	272 000	5 200
80	NKI 80/25	-	-	-	677	80	90	110	25	71 000	130 000	4 750
	NKI 80/35	-	-	-	959	80	90	110	35	101 000	207 000	4 750
	-	-	NA 4916	-	870	80	90	110	30	81 000	170 500	4 750
	-	-	-	NA 6916 - ZW	1 510	80	90	110	54	130 500	280 600	4 750
85	NKI 85/26	-	-	-	743	85	95	115	26	71 000	135 000	4 700
	NKI 85/36	-	-	-	1 040	85	95	115	36	105 000	222 000	4 700
	-	-	NA 4917	-	1 250	85	100	120	35	111 000	237 000	4 600
	-	-	-	NA 6917 - ZW	2 200	85	100	120	63	166 000	400 000	4 600
90	NKI 90/26	-	-	-	778	90	100	120	26	75 000	145 000	4 400
	NKI 90/36	-	-	-	1 090	90	100	120	36	109 000	235 500	4 400
	-	-	NA 4918	-	1 312	90	105	125	35	114 000	250 000	4 300
	-	-	-	NA 6918 - ZW	2 310	90	105	125	63	172 000	425 000	4 300
95	NKI 95/26	-	-	-	816	95	105	125	26	77 000	153 000	4 250
	NKI 95/36	-	-	-	1 145	95	105	125	36	112 000	235 000	4 250
	-	-	NA 4919	-	1 371	95	110	130	35	116 000	260 000	4 200
	-	-	-	NA 6919 - ZW	2 500	95	110	130	63	174 000	440 000	4 200
100	NKI 100/30	-	-	-	990	100	110	130	30	97 000	200 000	4 100
	NKI 100/40	-	-	-	1 330	100	110	130	40	127 000	280 000	4 100
	-	-	NA 4920	-	1 900	100	115	140	40	120 000	274 000	4 000
	-	NKIS 100	-	-	1 340	100	115	135	32	90 000	203 000	3 850
110	⁴ NKI 110/40	-	-	-	1 460	110	120	140	40	112 000	274 000	3 850
	-	-	NA 4922	-	2 070	110	125	150	40	132 000	290 000	3 700
	-	-	NA 4822	-	1 080	110	120	140	30	94 000	216 000	3 900
120	-	-	NA 4924	-	2 860	120	135	165	45	181 000	390 000	3 400
	-	-	NA 4824	-	1 170	120	130	150	30	99 000	239 000	3 600
130	-	-	NA 4926	-	3 900	130	150	180	50	203 000	470 000	3 100
	-	-	NA 4826	-	1 810	130	145	165	35	118 000	310 000	3 200

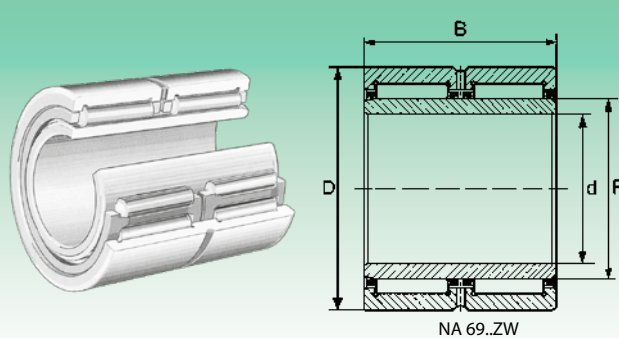
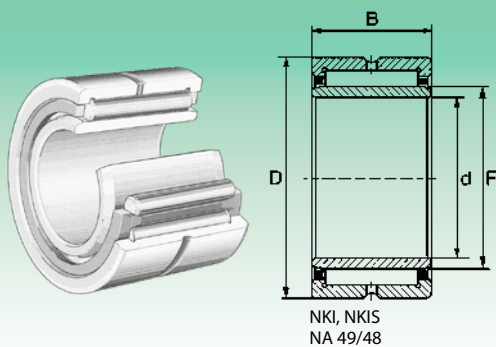

Diametro albero (mm) Shaft diameter (mm)	Sigla Designation				Peso (g) Weight (g)	Dimensioni (mm) Dimensions (mm)				Coefficienti di carico (N) Basic load ratings (N)		Velocità limite Limiting Speed Olio (N. giri max) Oil (max rpm)
	NKI	NKIS	NA49/48	NA69		d	F	D	B	Dinamico C Dynamic C	Statico C ₀ Static C ₀	
140	^a NKI 140/32	-	-	-	2 050	140	155	180	32	113 000	250 000	3 000
	-	-	NA 4928	-	4 150	140	160	190	50	209 000	500 000	2 900
	-	-	NA 4828	-	1 920	140	155	175	35	120 000	325 000	3 000
150	-	-	NA 4830	-	2 720	150	165	190	40	151 000	380 000	2 800
160	-	-	NA 4832	-	2 890	160	175	200	40	160 000	425 000	2 700
170	-	-	NA 4834	-	3 960	170	185	215	45	180 000	500 000	2 500
180	-	-	NA 4836	-	4 200	180	195	225	45	191 000	560 000	2 300
190	-	-	NA 4838	-	5 610	190	210	240	50	225 000	670 000	2 200
200	-	-	NA 4840	-	5 840	200	220	250	50	230 000	700 000	2 000
220	-	-	NA 4844	-	6 380	220	240	270	50	240 000	780 000	1 900
240	-	-	NA 4848	-	10 000	240	265	300	60	351 000	1 050 000	1 700
260	-	-	NA 4852	-	10 600	260	285	320	60	365 000	1 150 000	1 600
280	-	-	NA 4856	-	15 300	280	305	350	69	435 000	1 280 000	1 520
300	-	-	NA 4860	-	21 800	300	330	380	80	610 000	1 750 000	1 330
320	-	-	NA 4864	-	23 000	320	350	400	80	620 000	1 800 000	1 330
340	-	-	NA 4868	-	24 200	340	370	420	80	630 000	1 850 000	1 235
360	-	-	NA 4872	-	25 600	360	390	440	80	650 000	2 000 000	1 140
380	-	-	NA 4876	-	42 600	380	415	480	100	950 000	2 700 000	1 045

TN = Gabbia in plastica, temperatura d'esercizio ammissibile: 80°C (per funzionamento continuo).

TN = Plastic cage; temperature allowed: 80° (continuous working)

- Con anelli di chiusura, senza foro e gola di lubrificazione.
- With closing rings, without hole and lubrication groove.

- ^a Disponibile su richiesta.
- ^a Available under request.

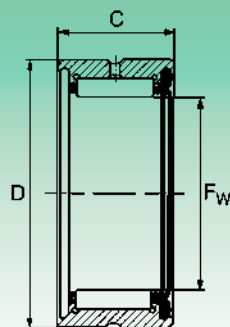
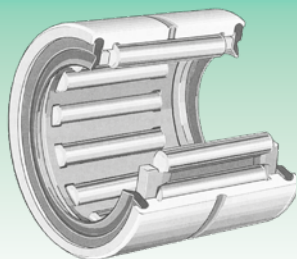
Cuscinetti a rullini con anelli di tenuta senza anello interno (serie RNA 49..RS • RNA 49..2RS)
Sealed needle roller bearings without inner ring (type RNA 49..RS • RNA 49..2RS)

RNA 49..RS

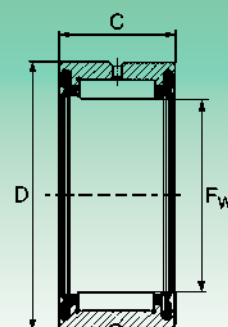

RNA 49..2RS

Diametro albero (mm) Shaft diameter (mm)	Sigla Designation		Peso (g) Weight (g)	Dimensioni (mm) Dimensions (mm)			Coefficienti di carico (N) Basic load ratings (N)		Velocità limite Limiting Speed
	Tenuta ad un lato Sealed on one side	Tenuta ad entrambi i lati Sealed on both sides		Fw	D	C	Dinamico C Dynamic C	Statico C _s Static C _s	
14	RNA 4900 RS	RNA 4900 2RS	16	14	22	13	6 460	6 550	12 350
16	RNA 4901 RS	RNA 4901 2RS	18	16	24	13	7 220	7 880	11 400
20	RNA 4902 RS	RNA 4902 2RS	21.5	20	28	13	8 170	9 780	9 500
22	RNA 4903 RS	RNA 4903 2RS	23	22	30	13	8 360	10 450	8 550
25	RNA 4904 RS	RNA 4904 2RS	56	25	37	17	16 450	18 900	7 150
30	RNA 4905 RS	RNA 4905 2RS	60	30	42	17	18 350	22 990	6 200
35	RNA 4906 RS	RNA 4906 2RS	69	35	47	17	20 050	27 100	5 220
42	RNA 4907 RS	RNA 4907 2RS	107	42	55	20	25 200	37 500	4 600
48	RNA 4908 RS	RNA 4908 2RS	154	48	62	22	34 200	50 350	4 000
52	RNA 4909 RS	RNA 4909 2RS	157	52	68	22	36 100	56 000	3 700
58	RNA 4910 RS	RNA 4910 2RS	160	58	72	22	38 000	60 800	3 400

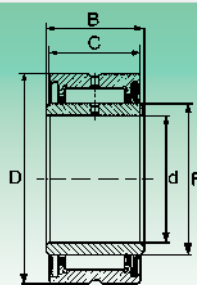
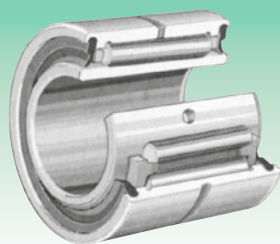
Cuscinetti a rullini con anelli di tenuta ed anello interno (serie NA 49..RS • NA 49..2RS)
Sealed needle roller bearings with inner ring (type NA 49..RS • NA 49..2RS)

NA 49..RS

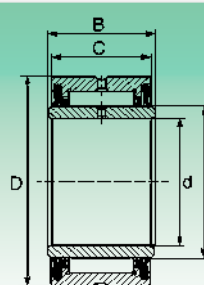

NA 49..2RS

Diametro albero (mm) Shaft Diameter (mm)	Sigla Designation		Peso (g) Weight (g)	Dimensioni (mm) Dimensions (mm)					Coefficienti di carico (N) Basic Load Rating (N)		Velocità limite Limiting Speed
	Tenuta ad un lato Sealed on one side	Tenuta ad entrambi i lati Sealed on both sides		d	F	D	C	B	Dinamico C Dynamic C	Statico C _s Static C _s	
10	NA 4900 RS	NA 4900 2RS	24.5	10	14	22	13	14	6 460	6 550	12 350
12	NA 4901 RS	NA 4901 2RS	27.5	12	16	24	13	14	7 220	7 880	11 400
15	NA 4902 RS	NA 4902 2RS	37	15	20	28	13	14	8 170	9 780	9 500
17	NA 4903 RS	NA 4903 2RS	40	17	22	30	13	14	8 360	10 450	8 550
20	NA 4904 RS	NA 4904 2RS	80	20	25	37	17	18	16 450	18 900	7 150
25	NA 4905 RS	NA 4905 2RS	89.5	25	30	42	17	18	18 350	22 990	6 200
30	NA 4906 RS	NA 4906 2RS	104	30	35	47	17	18	20 050	27 100	5 220
35	NA 4907 RS	NA 4907 2RS	175	35	42	55	20	21	25 200	37 500	4 600
40	NA 4908 RS	NA 4908 2RS	252	40	48	62	22	23	34 200	50 350	4 000
45	NA 4909 RS	NA 4909 2RS	290	45	52	68	22	23	36 100	56 000	3 700
50	NA 4910 RS	NA 4910 2RS	295	50	58	72	22	23	38 000	60 800	3 400





CUSCINETTI A RULLINI SENZA BORDI

NEEDLE ROLLER BEARINGS WITHOUT RIBS







Cuscinetti a rullini senza bordi

Needle roller bearings without ribs



I cuscinetti a rullini ISB della serie RNAO e NAO sono cuscinetti privi di bordi.

Sono particolarmente adatti per l'uso in presenza di ingombri limitati, le gabbie si possono montare, separatamente dagli anelli interni ed esterni.

Si consiglia l'utilizzo soprattutto per macchine tessili, utensili ed impianti di stampa.

Quando si raggiungono delle grandezze di una certa entità i cuscinetti vengono costruiti solo in esecuzione a due corone, con gola e foro di lubrificazione nell'anello esterno. I cuscinetti vengono, identificati dal suffisso [□] nelle tabelle dimensionali.

Cuscinetti a rullini senza bordi, senza anello interno

I cuscinetti a rullini senza bordi e privi di anello interno vengono impiegati direttamente sull'albero, utilizzato come pista di rotolamento, chiaramente l'albero, deve essere temprato e rettificato mantenendo una durezza il più possibile simile a quella dei rullini, in quanto questo permette di utilizzare al meglio, il cuscinetto per ciò che riguarda il carico sopportabile ed il numero massimo di giri, una maggiore precisione di rotazione ed una maggior durata.

Cuscinetti a rullini senza bordi, con anello interno

I cuscinetti a rullini senza bordi con anello interno devono essere necessariamente utilizzati quando non è possibile utilizzare l'albero come pista di rotolamento. L'anello esterno con la gabbia a rullini e l'anello interno possono essere, montati separatamente.

Nel caso, che occorra montare anche degli anelli di tenuta, si ricorda che sono disponibili degli anelli interni IR più larghi. Tutti i cuscinetti a rullini RNAO e NAO sono previsti normalmente con anello esterno privo di gola e foro di lubrificazione, mentre, al contrario nei cuscinetti a rullini a due corone (suffisso [□] nelle tabelle dimensionali) sono presenti entrambe le due caratteristiche. Si ricorda che i cuscinetti a rullini con anelli di tenuta, possono raggiungere, delle temperature con massimi di -30°C. a +80°C.

I cuscinetti a rullini vengono forniti con tolleranze dimensionali di classe PO e con giuoco normale, secondo le norme DIN. E' possibile su richiesta fornire dei cuscinetti a rullini ISB con classi di tolleranza P5 e P6 e con giuoco radiale C2 - C3 - C4.

ISB needle roller bearings of RNAO and NAO series are without ribs and particularly suitable for narrow dimensions, cages can be mounted separately from inner and outer rings.

Particularly suggested for textile machinery, printing machinery and tools.

In case of considerable sizes bearings are produced only with double rows execution, with groove and lubrication bores on outer ring.

Bearings are indicated by suffix [□] in dimensional tables.

Needle roller bearings without ribs and without inner ring

Bearings without ribs and without inner ring, are directly mounted on the shaft: this latter has to be hardened and grinded.

Its hardness must be as much as the one of needle rollers: this enables the bearing to better stand the load and rotations, and gives an higher precision and longer duration.

Needle roller bearings without ribs and with inner ring

When the shaft cannot be used as rolling groove, NAO bearings are assembled. Outer ring with needle roller cage and inner ring can be separately mounted.

We remind you that in case of an application requiring oil seals, IR wider inner rings are available.

All RNAO and NAO are usually supplied without lubrication hole and groove on the outer ring, whereas concerning double crowns needle roller bearings ([□] in tables) both characteristics are present.

Suggested temperature for sealed bearings, between -30°C. +80°C.

RNAO and NAO needle roller bearings are produced in accordance with DIN rules, with a normal radial clearance and PO tolerance dimensional class.

Under request they can be supplied with C2-C3-C4 radial clearance and P5, P6 precision class.

Tipologie dei cuscinetti a rullini senza bordi - Needle roller bearings without ribs types

Tipo-Type	Caratteristiche-Characteristics
RNAO RNAO..-ZW	Ad una corona e a due corone senza bordi, senza anello interno. Gabbia a rullini e anello esterno montabili separatamente. <i>With one or double row, without ribs and inner ring.</i> <i>Needle roller and outer rings can be fitted independently of each other.</i>
NAO NAO..-ZW	Ad una corona e a due corone senza bordi, con anello interno. Gabbia a rullini e anello esterno montabili separatamente. <i>With one or double row, with inner ring and without rib.</i> <i>Needle roller and outer rings can be fitted independently of each other.</i>



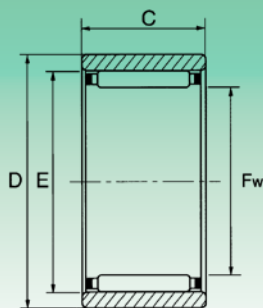
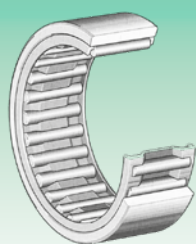

RNAO

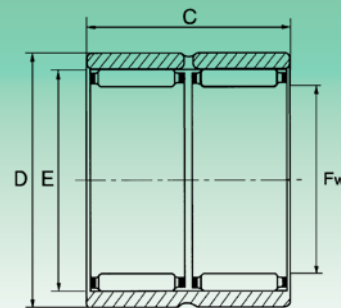
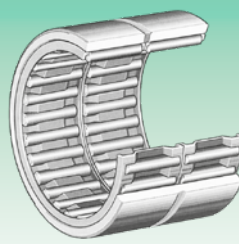

RNAO..ZW

Diametro albero (mm) Shaft diameter (mm)	Sigla Designation	Peso (g) Weight (g)	Dimensioni (mm) Dimensions (mm)				Coefficienti di carico (N) Basic load ratings (N)		Velocità limite Limiting Speed
			Fw	D	C	E	Dinamico C Dynamic C	Statico C _s Static C _s	Olio Oil
5	RNAO 5x10x8x TN	2.8	5	10	8	8	2 240	1 830	35 200
6	RNAO 6x13x8 TN	5	6	13	8	9	2 470	2 170	30 400
7	RNAO 7x14x8 TN	5	7	14	8	10	2 700	2 520	29 450
8	RNAO 8x15x10 TN	7.8	8	15	10	11	3 750	3 900	27 550
10	RNAO 10x17x10 TN	9.1	10	17	10	13	4 510	5 230	25 650
12	RNAO 12x19x13.5 TN	14	12	19	13.5	15	5 400	7 500	22 000
	RNAO 12x22x12 TN	17.9	12	22	12	18	9 500	9 400	22 800
15	RNAO 15x23x13	18.5	15	23	13	19	8 100	10 350	21 850
16	RNAO 16x24x13	19.8	16	24	13	20	8 450	11 200	20 900
	RNAO 16x24x20 - ZW	29.7	16	24	20	20	12 600	18 810	21 100
	RNAO 16x28x12	29.7	16	28	12	22	10 900	11 900	19 950
17	RNAO 17x25x13	21	17	25	13	21	9 900	13 900	20 900
18	RNAO 18x30x24 - ZW	65	18	30	24	24	20 800	28 500	19 000
20	RNAO 20x28x13	24.5	20	28	13	24	9 300	13 600	19 000
	RNAO 20x28x26 - ZW	48.1	20	28	26	24	15 950	27 100	19 000
	RNAO 20x32x12	36.6	20	32	12	26	12 750	15 400	18 000
22	RNAO 22x30x13	25.2	22	30	13	26	9 900	15 100	18 000
	RNAO 22x35x16	58	22	35	16	29	19 000	24 250	16 150
25	RNAO 25x35x17	49	25	35	17	29	14 150	24 700	15 200
	RNAO 25x35x26 - ZW	67.8	25	35	26	29	18 450	35 150	15 200
	RNAO 25x37x16	59.2	25	37	16	32	19 900	26 600	15 200
	RNAO 25x37x32 - ZW	108	25	37	32	32	25 000	38 900	12 000
26	RNAO 26x39x13	59	26	39	13	30	11 000	18 200	15 020
30	RNAO 30x40x17	59	30	40	17	35	18 600	32 300	13 300
	RNAO 30x40x26 - ZW	92	30	40	26	35	16 000	32 000	10 050
	RNAO 30x42x16	49.9	30	42	16	37	21 950	31 800	13 300
	RNAO 30x42x32 - ZW	126	30	42	32	37	37 500	63 650	13 300

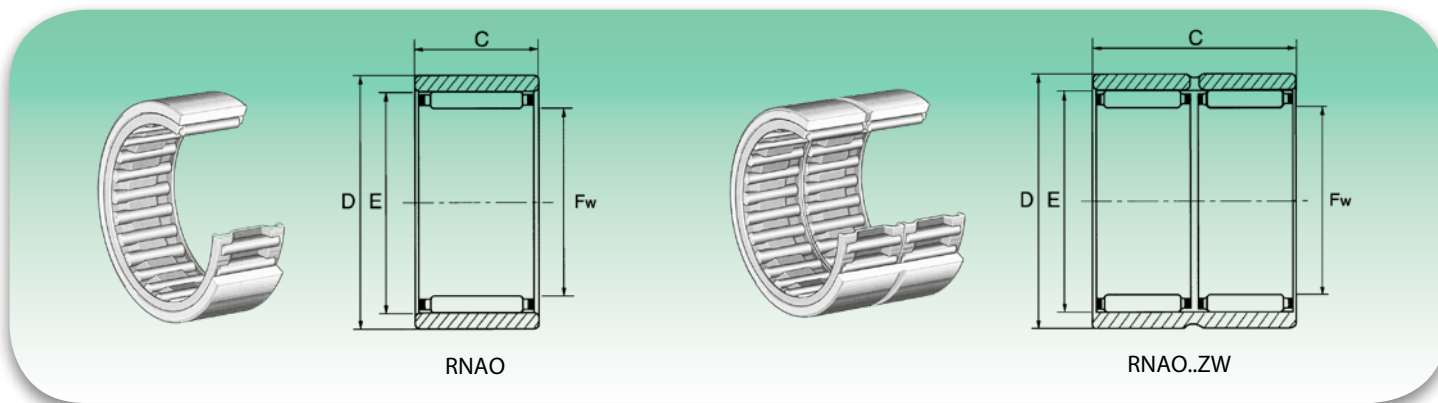
Cuscinetti a rullini senza bordi e senza anello interno - singola e doppia corona (serie RNAO)
Needle roller bearings without ribs and inner ring - single/double row (RNAO series)

Diametro albero (mm) Shaft diameter (mm)	Sigla Designation	Peso (g) Weight (g)	Dimensioni (mm) Dimensions (mm)				Coefficienti di carico (N) Basic load ratings (N)		Velocità limite Limiting Speed
			Fw	D	C	E	Dinamico C Dynamic C	Statico C _s Static C _s	Olio Oil
35	RNAO 35x45x13	50	35	45	13	40	15 400	26 600	11 400
	RNAO 35x45x17	60	35	45	17	40	19 750	36 600	11 400
	RNAO 35x45x26 - ZW	88	35	45	26	40	26 100	53 200	11 400
	RNAO 35x47x16	75	35	47	16	42	23 180	35 600	11 400
	RNAO 35x47x18	86	35	47	18	42	26 100	40 850	11 400
	RNAO 35x47x32 - ZW	149	35	47	32	42	39 900	71 250	11 400
37	RNAO 37x52x18	115	37	52	18	44	18 900	35 500	8 800
40	RNAO 40x50x17	72	40	50	17	45	20 350	39 400	10 450
	RNAO 40x50x34 - ZW	151	40	50	34	45	34 700	78 850	10 450
	RNAO 40x55x20	144	40	55	20	47	30 900	54 150	10 450
	RNAO 40x55x40 - ZW	268	40	55	40	48	58 900	112 100	9 500
42	RNAO 42x57x20	132	42	57	20	50	34 200	56 000	10 000
45	RNAO 45x55x17	82,5	45	55	17	50	21 400	43 700	9 500
	RNAO 45x62x40 - ZW	368	45	62	40	53	63 650	128 250	8 600
50	RNAO 50x62x20	140	50	62	20	55	25 200	57 000	8 600
	RNAO 50x65x20	162	50	65	20	58	33 700	58 900	8 100
	RNAO 50x65x40 - ZW	321	50	65	40	58	57 950	117 800	8 100
55	RNAO 55x68x20	157	55	68	20	60	27 100	62 700	7 600
60	RNAO 60x78x20	253	60	78	20	68	41 300	80 750	6 700
	RNAO 60x78x40 - ZW	435	60	78	40	68	71 250	162 450	6 700
65	RNAO 65x85x30	464	65	85	30	73	54 150	116 850	6 200
70	RNAO 70x90x30	488	70	90	30	78	57 000	128 250	5 700
80	RNAO 80x100x30	527	80	100	30	88	67 450	167 200	5 300
85	RNAO 85x105x25	449	85	105	25	93	54 150	129 200	4 900
	RNAO 90x105x26	373	90	105	26	98	57 950	142 500	4 750
90	RNAO 90x110x30	600	90	110	30	98	64 600	163 400	4 700
	RNAO 100x120x30	671	100	120	30	108	67 450	178 600	4 300

TN = Gabbia in plastica, temperatura d'esercizio ammissibile: 80°C (funzionamento continuo).

TN = Plastic cage; temperature allowed: 80°C (continuous working).

ZW = A due corone, con gola e foro di lubrificazione.

ZW = Double row, with groove and lubrication hole.

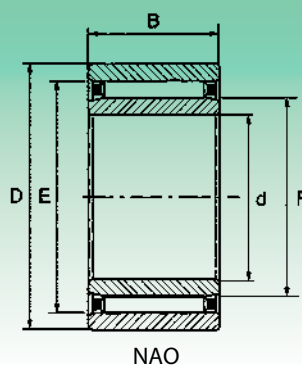

NAO

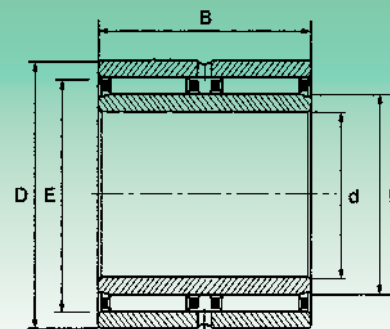
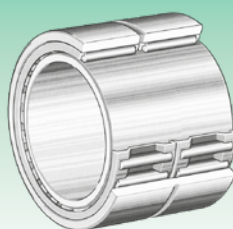

NAO..ZW

Diametro albero (mm) Shaft diameter (mm)	Sigla Designation	Peso (g) Weight (g)	Dimensioni (mm) Dimensions (mm)					Coefficienti di carico (N) Basic load ratings (N)		Velocità limite Limiting Speed
			d	D	B	F	E	Dinamico C Dynamic C	Statico C _s Static C _s	
6	• NAO 6x17x10 TN	13	6	17	10	10	13	4 500	5 200	27 550
9	NAO 9x22x12 TN	22	9	22	12	12	18	9 500	9 400	23 750
12	NAO 12x24x13	29	12	24	13	16	20	8 450	11 200	22 800
	NAO 12x24x20	43	12	24	20	16	20	12 635	18 810	22 800
	NAO 12x28x12	38.6	12	28	12	16	22	10 900	11 900	20 900
15	NAO 15x28x13	27.8	15	28	13	20	24	9 300	13 600	20 900
	NAO 15x32x12	48.1	15	32	12	20	26	12 700	15 400	20 000
17	NAO 17x30x13	39	17	30	13	22	26	9 860	15 000	20 000
	NAO 17x35x16	70	17	35	16	22	29	19 000	24 200	18 000
20	NAO 20x35x17	72	20	35	17	25	29	14 200	24 700	17 100
	NAO 20x37x16	81	20	37	16	25	32	19 900	26 600	16 150
25	NAO 25x40x17	78.9	25	40	17	30	35	18 600	32 300	14 250
	• NAO 25x42x16	83	25	42	16	30	37	21 900	31 800	14 250
	NAO 25x42x32 - ZW	189	25	42	32	30	37	37 500	63 650	14 250
30	NAO 30x45x13	73	30	45	13	35	40	15 390	26 600	12 000
	NAO 30x45x17	100	30	45	17	35	40	19 760	36 600	12 350
	NAO 30x45x26 - ZW	150	30	45	26	35	40	26 100	53 200	12 350
	NAO 30x47x16	99.8	30	47	16	35	42	23 180	35 600	12 350
	NAO 30x47x18	109	30	47	18	35	42	26 100	40 850	12 350
	NAO 30x52x18	172	30	52	18	37	44	26 600	43 225	11 000
35	NAO 35x50x17	103	35	50	17	40	45	20 800	40 506	10 000
	NAO 35x55x20	175	35	55	20	40	47	30 900	54 150	10 450
	# NAO 35x57x20.5	206	35	57	20.5	42	50	34 200	56 050	10 000
40	NAO 40x55x17	118	40	55	17	45	50	21 400	43 700	9 500
	• NAO 40x65x20	269	40	65	20	50	58	35 000	61 200	8 000
50	• NAO 50x68x20	219	50	68	20	55	60	27 100	62 700	8 100
	• NAO 50x78x20	400	50	78	20	60	68	41 325	80 750	6 500
70	NAO 70x100x30	829	70	100	30	80	88	67 450	167 200	5 700
75	NAO 75x100x25	676	75	105	25	85	93	54 150	129 200	5 000
80	NAO 80x110x30	892	80	110	30	90	98	64 600	163 400	4 750
90	NAO 90x120x30	1 004	90	120	30	100	108	67 450	178 600	4 500

TN = Gabbia in plastica, temperatura d'esercizio ammissibile: 80°C (funzionamento continuo).

TN = Plastic cage; temperature allowed: 80°C (continuous working).

ZW = A due corone, con gola e foro di lubrificazione nell'anello esterno

ZW = Double row, with groove and lubrication hole in the outer rings

Larghezza anello esterno = 20 mm.

Width of outer ring = 20 mm.

• Foro di lubrificazione nell'anello interno

• Lubrication hole in inner ring



CUSCINETTI ORIENTABILI A RULLINI

ALIGNING NEEDLE ROLLER BEARINGS







Cuscinetti orientabili a rullini

Aligning needle roller bearings



I cuscinetti orientabili a rullini hanno come caratteristica principale quella di avere una orientabilità dell'anello esterno, grazie ad una serie di anelli di appoggio in plastica che sono inseriti tra l'anello esterno e l'astuccio. Questa caratteristica permette inoltre l'assorbimento di eventuali disallineamenti dell'albero fino ad un massimo di 2°/3°. La gabbia a rullini, l'anello esterno e l'astuccio esterno costituiscono un unico gruppo di montaggio. Occorre ricordare che i cuscinetti orientabili a rullini montando degli anelli di appoggio in plastica, non devono superare delle temperature comprese tra i -30°C. ed i +80°C. I cuscinetti orientabili a rullini devono essere montati con interferenza nel foro di alloggiamento, inoltre l'orientabilità viene garantita dall'accoppiamento dell'astuccio e dell'anello esterno.

Aligning heavy duty needle roller bearings have an orientable outer ring, this is possible thanks to a series of plastic support rings inserted between the outer ring and the drawn cup. This characteristic enables the absorption of possible shaft misalignment up to 2°/3°. Needle roller cage, outer ring and drawn cup create a sole mounting group. Important is to remember that with heavy duty needle roller bearings, plastic support rings are assembled, therefore temperature has to be within -30°C and +80°C.

Aligning heavy duty needle bearings are assembled with interference inside the housing bore, furthermore their orientability is guaranteed by the coupling of drawn cup and outer ring.

Tipo-Type	Caratteristiche-Characteristics
RPNA	Orientabili a rullini senza anello interno <i>Aligning without inner ring</i>
PNA	Orientabili a rullini con anello interno <i>Aligning with inner ring</i>



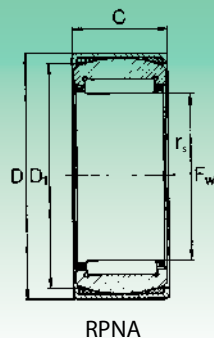

RPNA

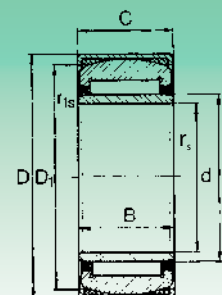
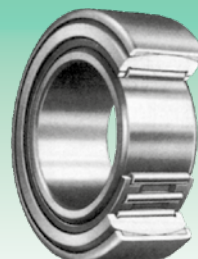

PNA

RPNA

Diametro albero (mm) Shaft Diameter (mm)	Sigla Designation	Peso (g) Weight (g)	Dimensioni (mm) Dimensions (mm)					Coefficienti di carico (N) Basic Load Rating (N)		Velocità limite ²⁾ Limiting Speed
			F _w	D	C ± 0,5	D ₁	r _s min.	Dinamico C Dynamic C	Statico C ₀ Static C ₀	Olio / Oil
										(N° giri max) (max rpm)
15	RPNA 15/28	32	15	28	12	24.5	0.8	6 500	7 500	24 000
18	RPNA 18/32	52	18	32	16	27	0.8	11 900	15 400	22 000
20	RPNA 20/35	62	20	35	16	30.5	0.8	12 350	16 600	21 000
25	RPNA 25/42	109	25	42	20	36.5	0.8	17 800	29 000	18 000
28	RPNA 28/44	112	28	44	20	38.5	0.8	20 900	32 300	16 000
30	RPNA 30/47	125	30	47	20	42	0.8	21 500	34 200	15 000
35	RPNA 35/52	131	35	52	20	47.5	0.8	23 100	39 400	13 000
40	RPNA 40/55	141	40	55	20	50.5	0.8	24 700	44 650	11 000
45	RPNA 45/62	176	45	62	20	58	0.8	26 100	50 350	10 000

PNA

Diametro albero (mm) Shaft Diameter (mm)	Sigla Designation	Peso (g) Weight (g)	Dimensioni (mm) Dimensions (mm)									Coefficienti di carico (N) Basic Load Rating (N)		Velocità limite ²⁾ Limiting Speed
			d	F	D	B	C ± 0,5	D ₁	r _s min.	r _{1s} min.	S ₁₁	Dinamico C Dynamic C	Statico C ₀ Static C ₀	Olio / Oil
														(N° giri max) (max rpm)
12	PNA 12/28	37	12	15	28	12	12	24.5	0.8	0.3	0.5	6 500	7 500	24 000
15	PNA 15/32	62	15	18	32	16	16	27	0.8	0.3	0.5	11 900	15 400	22 000
17	PNA 17/35	73	17	20	35	16	16	30.5	0.8	0.3	0.5	12 350	16 600	21 000
20	PNA 20/42	136	20	25	42	20	20	36.5	0.8	0.3	0.5	17 800	29 000	18 000
22	PNA 22/44	145	22	28	44	20	20	38.5	0.8	0.3	0.5	20 900	32 300	16 000
25	PNA 25/47	157	25	30	47	20	20	42	0.8	0.3	0.5	21 500	34 200	15 000
30	PNA 30/52	181	30	35	52	20	20	47.5	0.8	0.3	0.5	23 100	39 400	13 000
35	PNA 35/55	177	35	40	55	20	20	50.5	0.8	0.3	0.5	24 700	44 650	11 000
40	PNA 40/62	227	40	45	62	20	20	58	0.8	0.3	0.5	26 100	50 350	10 000

1) Scostamento assiale ammesso dell'anello interno, dalla posizione intermedia.

Axial deviation allowed of inner ring from intermediate position.

2) Per lubrificazione a grasso è consentito un numero di giri pari al 60% dei valori indicati.

For grease lubrication, revolutions allowed are 60% of indicated value.



CUSCINETTI COMBINATI A RULLINI

COMBINED NEEDLE ROLLER BEARINGS







Cuscinetti combinati a rullini Combined needle roller bearings



I cuscinetti della serie NX, NKX e NKXR vengono forniti senza anello interno in quanto si utilizza l'albero come pista di rotolamento, naturalmente l'albero andrà rettificato e temprato per avere la giusta compatibilità con la durezza dei rullini. Se non è possibile temprare l'albero sarà necessario l'uso di appositi anelli interni IR (vedi tabelle specifiche).

Se il cuscinetto deve assorbire dei carichi assiali bidirezionali si consiglia di effettuare un montaggio di due cuscinetti contrapposti della stessa serie.

L'anello esterno del cuscinetto della serie NX prevede una scanalatura dove poter montare un anello elastico che avrà il preciso compito di bloccare il cuscinetto nel caso che debba sopportare dei carichi di tipo assiale.

I cuscinetti delle serie sopraindicate fatta eccezione per quelli che portano il suffisso "Z" possono essere lubrificati ad olio e grasso. I cuscinetti con calotta di chiusura sono forniti lubrificati prima del montaggio nella parte assiale, mentre per ciò che riguarda la parte radiale dovranno essere lubrificati prima della messa in funzione con un grasso compatibile a quello già esistente.

NX, NKX and NKXR combined roller bearings have no inner ring as the shaft is used as rolling groove: the shaft is grinded and hardened and has to have the same hardness of needle rollers.

When is not possible to harden the shaft the use of IR inner rings is required (see special tables).

Should the bearings stand axial loads in two directions, a mounting of two bearings in opposition of the same series is required.

The outer ring of a NX bearing is provided with a groove able to accept an elastic ring, which has the duty of stopping the bearings in case of axial loads. Excepted "Z" type, the above bearings can be oil or grease lubricated. Closed combined roller bearings are prelubricated before mounting in their axial part, whereas concerning radial part they must be lubricated, before beginning, with compatible grease.

Tipologie dei cuscinetti combinati a rullini - Combined needle roller bearings types

Tipo-Type	Caratteristiche-Characteristics
NX, NX..-Z	Combinato con cuscinetto assiale a pieno riempimento di sfere, con calotta di protezione (per carichi assiali medi) <i>Combined with a full ball filling axial bearing, provided with retaining cap (for average axial loads)</i>
NKX, NKX..-Z	Combinato con cuscinetto assiale a sfere, con e senza calotta di protezione (per carichi assiali elevati) <i>Combined with an axial ball bearing, with/without retaining cap (for high axial loads)</i>
NKXR, NKXR..-Z	Combinato con cuscinetto assiale a rulli cilindrici, con e senza calotta di protezione, (per carichi assiali molto elevati) <i>Combined with an axial cylindrical roller bearing, with/without retaining cap (for the highest axial loads)</i>
NKIA	Combinato con cuscinetto a sfere a contatto obliquo monodirezionale (per carichi assiali ridotti) <i>Combined with an oblique unidirectional contact ball bearing (for curbed axial loads)</i>
NKIB	Combinato con cuscinetto a sfere a contatto obliquo bidirezionale (per carichi assiali ridotti) <i>Combined with an oblique contact bidirectional ball bearing (for curbed axial loads)</i>



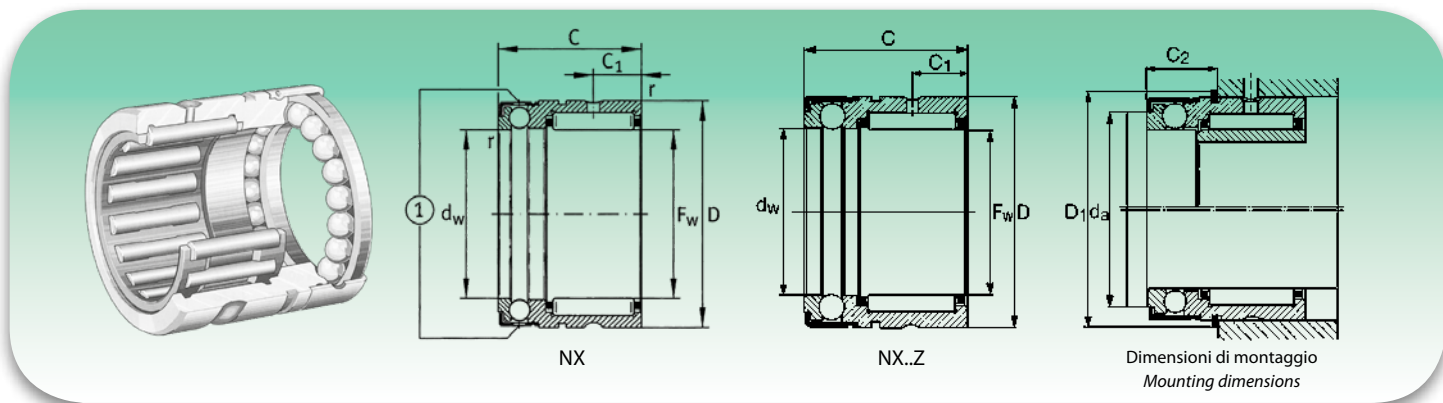

Diametro albero (mm) Shaft diameter (mm)	Sigla Designation			Dimensioni (mm) Dimensions (mm)					Coefficienti di carico (N) Basic load ratings (N)				Velocità limite Limiting Speed (N. giri max) (max rpm)	Dimensioni di Montaggio (mm) Mounting Dimensions (mm)		
	Lubrificazione ad olio Oil lubrication	Lubrificazione con grasso Grease lubrication	Peso (g) Weight (g)	F _w	D	C -0,25	C ₁	d _w	Radiale / Radial		Assiale / Axial ¹⁾			C ₂ -0,5	D ₁	d _a
									Din./Dyn C	Stat./Stat C _c	Din./Dyn C	Stat./Stat C _c				
7	• NX 7 TN	• NX 7 Z TN	14	7	14	18	4.7	7	2 700	2 510	3 200	4 300	15 000	10	16.5	9.6
10	NX 10	NX 10 Z	25	10	19	18	4.7	10	4 200	3 500	4 900	7 400	11 000	10	21.9	14.6
12	NX 12	NX 12 Z	28	12	21	18	4.7	12	4 500	4 100	5 100	8 450	9 500	10	23.7	16.6
15	NX 15	NX 15 Z	48	15	24	28	8	15	10 500	11 500	5 900	10 500	8 000	12.2	26.5	19
17	NX 17	NX 17 Z	53	17	26	28	8	17	11 000	14 000	6 100	11 500	7 500	12.2	28.5	21
20	NX 20	NX 20 Z	68	20	30	28	8	20	12 000	16 000	6 500	15 000	6 500	12.2	33.6	25
25	NX 25	NX 25 Z	115	25	37	30	8	25	14 000	21 000	11 000	24 000	4 900	14.2	40.4	31.6
30	NX 30	NX 30 Z	130	30	42	30	10	30	21 000	34 000	12 000	28 000	4 300	14.2	45.1	36.5
35	NX 35	NX 35 Z	160	35	47	30	10	35	23 000	40 000	13 000	34 000	3 700	14.2	50.1	40.5

TN= Gabbia in plastica, temperatura di esercizio ammissibile: 80°C (per funzionamento continuo).

TN= Plastic cage; temperature allowed: 80°C. (continuous working).

1) Carico assiale F_a da 1% al 2% del coefficiente di carico dinamico C (assiale).

F_a axial load from 1% to 2% of C basic dynamic load rating (axial).

In caso di lubrificazione a grasso, è ammesso un n° di giri pari al 60% dei valori riportati in tabella

For grease lubrication number of allowed revolution is 60% of value expressed in table (see specifications for different grease)

- Foro per olio di lubrificazione.
Holes for lubricating oil.

Cuscinetti combinati radiali a rullini ed assiali a sfere (serie NKX • NKX..Z)

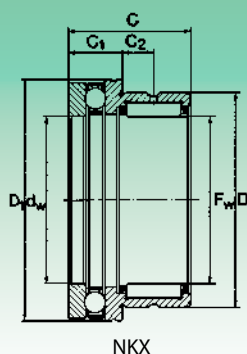
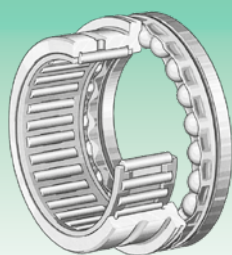
Needle roller axial ball bearings (NKX • NKX..Z series)

NKX

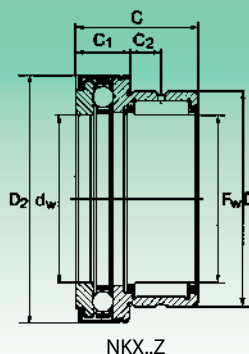

NKX..Z

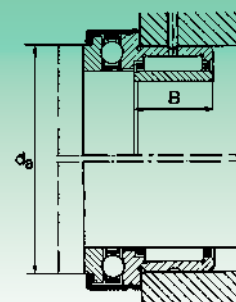
 Dimensioni di montaggio
Mounting dimensions

Diametro albero (mm) Shaft diameter (mm)	Sigla Designation				Dimensioni (mm) Dimensions (mm)								Coefficienti di carico (N) Basic load rating (N)				Velocità limite Limiting Speed (N. giri max) (max rpm)	Dimensioni Montaggio Mounting Dimensions d _a (mm)
	Senza calotta Without retaining cap	Peso (g) Weight (g)	Con calotta With retaining cap	Peso (g) Weight (g)	F _w	D	D ₁ max	D ₂ max	C -0,25	C ₁ -0,2	C ₂	d _w	Radiale / Radial		Assiale / Axial ¹⁾			
													Din./Dyn C	Stat./Stat C _e	Din./Dyn C	Stat./Stat C _e		
10	• NKX 10TN	34	• NKX 10 Z TN	36	10	19	24.1	25.2	23	9	6.5	10	6 000	7 500	9 500	13 000	12 000	19.7
12	NKX 12	38	NKX 12 Z	40	12	21	26.1	27.2	23	9	6.5	12	8 500	10 500	10 000	15 000	11 000	21.7
15	NKX 15	44	NKX 15 Z	47	15	24	28.1	29.2	23	9	6.5	15	10 000	12 000	10 000	16 000	9 500	23.7
17	NKX 17	53	NKX 17 Z	55	17	26	30.1	31.2	25	9	8	17	11 000	14 500	10 500	17 900	8 500	25.7
20	NKX 20	83	NKX 20 Z	90	20	30	35.1	36.2	30	10	10.5	20	15 000	22 500	13 500	23 000	7 500	30.7
25	NKX 25	125	NKX 25 Z	132	25	37	42.1	43.2	30	11	9.5	25	17 000	30 000	18 000	35 000	6 000	37.7
30	NKX 30	141	NKX 30 Z	148	30	42	47.1	48.2	30	11	9.5	30	21 000	34 000	19 000	39 500	5 000	42.7
35	NKX 35	163	NKX 35 Z	168	35	47	52.1	53.2	30	12	9	35	23 000	40 000	20 500	44 650	4 600	47.7
40	NKX 40	200	NKX 40 Z	208	40	52	60.1	61.2	32	13	10	40	25 000	45 000	26 000	60 000	4 000	55.7
45	NKX 45	252	NKX 45 Z	265	45	58	65.2	66.5	32	14	9	45	26 500	51 000	27 000	67 000	3 600	60.5
50	NKX 50	280	NKX 50 Z	300	50	62	70.2	71.5	35	14	10	50	36 000	72 000	28 000	72 000	3 300	65.5
60	NKX 60	360	NKX 60 Z	380	60	72	85.2	86.5	40	17	12	60	41 000	88 000	40 000	110 000	2 800	80.5
70	NKX 70	500	NKX 70 Z	520	70	85	95.2	96.5	40	18	11	70	42 500	91 000	42 000	120 000	2 400	90.5

TN= Gabbia in plastica, temperatura di esercizio ammissibile: 80°C (per funzionamento continuo).

TN= Plastic cage; temperature allowed: 80°C. (continuous working).

1) Carico assiale F, da 1% al 2% del coefficiente di carico dinamico C (assiale).

F_a axial load from 1% to 2% of C basic dynamic load rating (axial).

In caso di lubrificazione a grasso, è ammesso un n° di giri pari al 60% dei valori riportati in tabella

For grease lubrication number of allowed revolution is 60% of value expressed in table (see specifications for different grease)

- Foro per olio di lubrificazione.
Holes for lubricating oil.

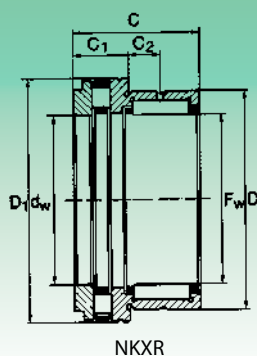
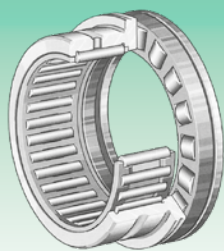

NKXR

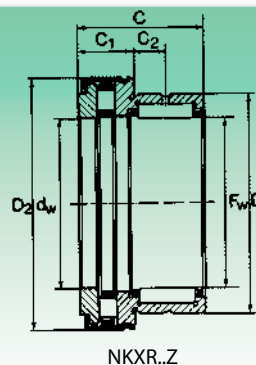

NKXR.Z

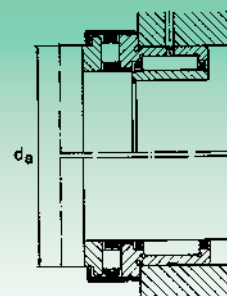
 Dimensioni di montaggio
Mounting dimensions

Diametro albero (mm) Shaft diameter (mm)	Sigla Designation				Dimensioni (mm) Dimensions (mm)								Coefficienti di carico (N) Basic load ratings (N)				Velocità limite Limiting Speed	Dimensioni Montaggio Mounting Dimensions
	Senza calotta Without retaining cap	Peso (g) Weight (g)	Con calotta With retaining cap	Peso (g) Weight (g)	F _w	D	D ₁ max	D ₂ max	C -0,25	C ₁ -0,2	C ₂	d _w	Radiale / Radial		Assiale / Axial ¹⁾		Olio/Oil (N. giri max) (max rpm)	d _a (mm)
													Din./Dyn C	Stat./Stat C _r	Din./Dyn C	Stat./Stat C _r		
15	NKXR 15	42	NKXR 15 Z	45	15	24	28.1	29.2	23	9	6.5	15	10 500	11 500	13 500	27 500	12 350	23.7
17	NKXR 17	50	NKXR 17 Z	53	17	26	30.1	31.2	25	9	8	17	11 000	14 000	15 000	32 500	11 400	25.7
20	NKXR 20	80	NKXR 20 Z	84	20	30	35.1	36.2	30	10	10.5	20	15 000	23 000	23 500	52 500	9 500	30.7
25	NKXR 25	120	NKXR 25 Z	125	25	37	42.1	43.2	30	11	9.5	25	17 000	29 000	32 000	75 000	8 100	37.7
30	NKXR 30	135	NKXR 30 Z	141	30	42	47.1	48.2	30	11	9.5	30	21 000	34 000	34 500	85 000	7 100	42.7
35	NKXR 35	157	NKXR 35 Z	165	35	47	52.1	53.2	30	12	9	35	23 500	40 000	38 000	98 000	6 200	47.7
40	NKXR 40	204	NKXR 40 Z	214	40	52	60.1	61.2	32	13	10	40	25 000	45 000	54 000	143 000	5 700	55.7
45	NKXR 45	244	NKXR 45 Z	260	45	58	65.2	66.5	32	14	9	45	26 500	51 000	57 000	162 000	4 750	60.6
50	NKXR 50	268	NKXR 50 Z	288	50	62	70.2	71.5	35	14	10	50	36 000	72 000	60 500	169 000	4 560	65.5

Le gabbie assiali sono in plastica, temperatura di esercizio ammissibile: 80°C (per funzionamento continuo).

Ball cages are made of plastic; allowed temperature: 80° (continuous working).

1) Carico assiale F, da 1% al 2% del coefficiente di carico dinamico C (assiale).

F, axial load from 1% to 2% of C basic dynamic load rating (axial).

In caso di lubrificazione a grasso, è ammesso un n° di giri pari al 60% dei valori riportati in tabella

For grease lubrication number of allowed revolution is 60% of value expressed in table (see specifications for different grease)

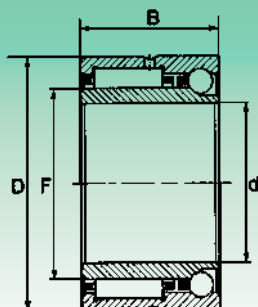
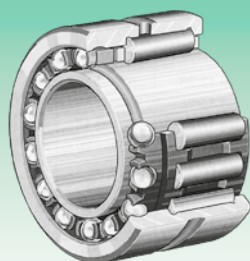
Cuscinetti combinati a rullini ed obliqui a sfera monodirezionali (serie NKIA)
Needle roller angular contact ball bearings single direction (NKIA series)

NKIA

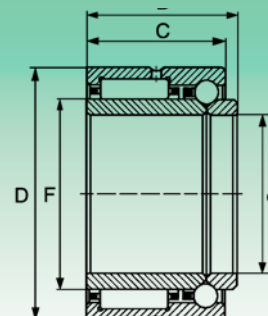
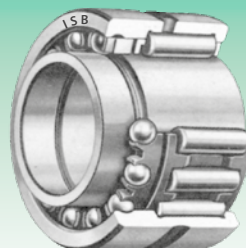

NKIB

Diametro albero (mm) Shaft diameter (mm)	Sigla Designation	Peso (g) Weight (g)	Dimensioni (mm) Dimensions (mm)				Coefficienti di carico (N) Basic load ratings (N)				Velocità limite Limiting Speed (N. giri max) (max rpm)
			d	F	D	B	Radiale / Radial		Assiale / Axial		
							Dinamico C Dynamic C	Statico C ₀ Static C ₀	Dinamico C Dynamic C	Statico C ₀ Static C ₀	
12	NKIA 5901	40	12	16	24	16	7 200	7 900	2 052	2 138	22 800
15	NKIA 5902	50	15	20	28	18	10 070	12 900	2 223	2 613	20 900
17	NKIA 5903	56	17	22	30	18	10 450	13 870	2 375	3 040	19 950
20	NKIA 5904	103	20	25	37	23	19 950	24 200	3 753	4 608	16 150
22	NKIA 59/22	118	22	28	39	23	21 660	28 000	4 038	5 320	15 200
25	NKIA 5905	130	25	30	42	23	22 400	29 900	4 133	5 795	14 250
30	NKIA 5906	147	30	35	47	23	23 750	33 700	4 513	6 935	12 350
35	NKIA 5907	243	35	42	55	27	29 900	47 500	5 700	9 310	10 450
40	NKIA 5908	315	40	48	62	30	40 850	63 650	7 030	12 065	9 000
45	NKIA 5909	375	45	52	68	30	42 750	69 350	7 315	13 300	8 100
50	NKIA 5910	380	50	58	72	30	44 650	76 000	7 695	15 105	7 600
55	NKIA 5911	550	55	63	80	34	55 100	95 000	9 215	18 240	7 100
60	NKIA 5912	590	60	68	85	34	57 000	102 600	9 500	10 260	6 650
65	NKIA 5913	635	65	72	90	34	57 950	106 400	9 785	21 185	6 200
70	NKIA 5914	980	70	80	100	40	79 800	148 200	12 825	27 550	5 700

Cuscinetti combinati a rullini ed obliqui a sfera bidirezionali (serie NKIB)
Needle roller angular contact ball bearings double direction (NKIB series)

Diametro albero (mm) Shaft diameter (mm)	Sigla Designation	Peso (g) Weight (g)	Dimensioni (mm) Dimensions (mm)					Coefficienti di carico (N) Basic load ratings (N)				Velocità limite Limiting Speed (N. giri max) (max rpm)
			d	F	D	B	C	Radiale / Radial		Assiale / Axial		
								Dinamico C Dynamic C	Statico C ₀ Static C ₀	Dinamico C Dynamic C	Statico C ₀ Static C ₀	
12	NKIB 5901	43	12	16	24	17.5	16	7 200	7 900	2 052	2 138	22 800
15	NKIB 5902	52	15	20	28	20	18	10 070	12 900	2 223	2 613	20 900
17	NKIB 5903	58	17	22	30	20	18	10 450	13 870	2 375	3 040	19 950
20	NKIB 5904	107	20	25	37	25	23	19 950	24 200	3 753	4 608	16 150
22	NKIB 59/22	122	22	28	39	25	23	21 660	28 000	4 038	5 320	15 200
25	NKIB 5905	134	25	30	42	25	23	22 400	29 900	4 133	5 795	14 250
30	NKIB 5906	151	30	35	47	25	23	23 750	33 700	4 513	6 935	12 350
35	NKIB 5907	247	35	42	55	30	27	29 900	47 500	5 700	9 310	10 450
40	NKIB 5908	320	40	48	62	34	30	40 850	63 650	7 030	12 065	9 000
45	NKIB 5909	380	45	52	68	34	30	42 750	69 350	7 315	13 300	8 100
50	NKIB 5910	385	50	58	72	34	30	44 650	76 000	7 695	15 105	7 600
55	NKIB 5911	555	55	63	80	38	34	55 100	95 000	9 215	18 240	7 100
60	NKIB 5912	595	60	68	85	38	34	57 000	102 600	9 500	10 260	6 650
65	NKIB 5913	640	65	72	90	38	34	57 950	106 400	9 785	21 185	6 200
70	NKIB 5914	985	70	80	100	45	40	79 800	148 200	12 825	27 550	5 700

Le gabbie a sfere sono in plastica, temperatura di esercizio ammissibile: 80°C (per funzionamento continuo).

Ball cages are made of plastic; allowed temperature: 80° (continuous working).





ANELLI INTERNI

INNER RINGS







Gli anelli interni per i cuscinetti a rullini ISB offrono la possibilità di adottare delle soluzioni precise ed economicamente più vantaggiose nel caso che non si possa utilizzare l'albero come pista di rotolamento del cuscinetto. Gli anelli interni sono disponibili con diverse larghezze e in due diverse serie IR e LR.

La differenza fondamentale tra i due diversi tipi di anelli sta nel fatto che gli anelli IR sono rifiniti in modo migliore, mentre gli anelli LR sono più economici e solitamente utilizzati in combinazione con cuscinetti senza e con fondello.

Entrambi i tipi di anelli sono forniti con uno smusso che ne agevola il montaggio. Gli anelli interni IR possono essere disponibili in diverse esecuzioni a seconda delle esigenze della clientela, quindi con maggiore precisione (classe di tolleranza P5 e P6) oppure con giuoco C2 - C3 - C4 e con foro di lubrificazione. Gli anelli interni LR sono temprati e finiti di precisione anche se le superfici laterali non sono rettificatae, inoltre non sono disponibili in esecuzioni speciali ma solo standard.

ISB inner rings offer the possibility to adopt more advantageous and correct solutions when the shaft cannot be used as a rolling groove for the bearing.

Inner rings are available with different width and in two different series: IR and LR.

IR are well finished whereas LR are cheaper and usually combined with bearings open or closed end, both rings are supplied with a chamfer to facilitate their mounting.

IR rings are available in different versions as per customers requirements: greater precision (P5 and P6 tolerance class), C2-C3-C4 radial clearance and with lubrication hole.

LR rings are hardened and well finished even if lateral surfaces are not grinded; special executions are not available, only standard types.

Tipologie degli anelli interni - Inner ring types

Tipo-Type	Caratteristiche-Characteristics
IR	Con tolleranze secondo norme DIN. <i>With tolerance conforming to DIN rules.</i>
LR	Con tolleranze più ampie. <i>With wider tolerances</i>



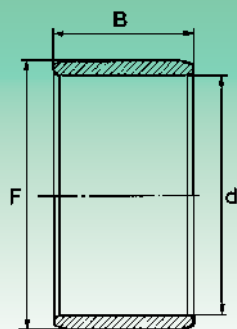
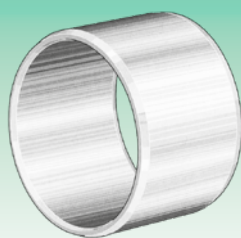

IR

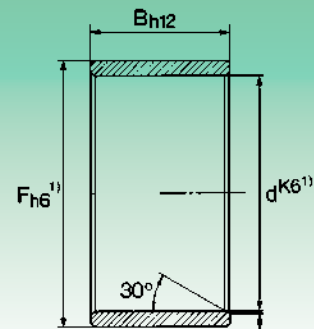
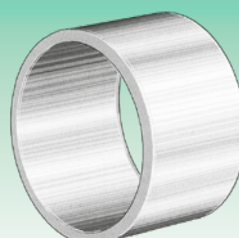

LR

Diametro albero (mm) Shaft diameter (mm)	Sigla Designation	Peso (g) Weight (g)	Dimensioni (mm) Dimensions (mm)		
			d	F	B
5	IR -	2.79	5	8	12
	IR -	3.75	5	8	16
6	IR -	3.17	6	9	12
	IR -	4.3	6	9	16
	□ IR -	3.7	6	10	10
7	IR LR	3.09	7	10	10.5
	IR -	3.61	7	10	12
8	IR -	4.9	7	10	16
	□ IR -	4.8	8	12	10
	IR LR	5	8	12	10.5
	□ IR -	5.7	8	12	12
9	IR LR	5.9	8	12	12.5
	IR -	4.5	9	12	12
10	IR -	6.1	9	12	16
	IR LR	5.2	10	13	12.5
	□ IR -	7.3	10	14	12
	IR -	7.4	10	14	13
	IR -	8	10	14	14
	IR -	9.2	10	14	16
12	IR -	11.6	10	14	20
	IR -	5.8	12	15	12
	IR LR	6.1	12	15	12.5
	IR -	8	12	15	16
	IR LR	8.1	12	15	16.5
	IR LR	10.9	12	15	22.5
	IR -	7	12	16	10
	□ IR -	7.9	12	16	12
	IR -	8.7	12	16	13
	IR -	9.5	12	16	14
	IR -	10.9	12	16	16
14	IR -	13.5	12	16	20
	IR -	14.9	12	16	22
	IR -	10	14	17	17
	- LR	7.2	15	18	12.5
15	IR -	9.6	15	18	16
	IR LR	9.9	15	18	16.5
	IR -	12.8	15	19	16
	IR -	16.4	15	19	20
	□ IR -	12.1	15	20	12

Diametro albero (mm) Shaft diameter (mm)	Sigla Designation	Peso (g) Weight (g)	Dimensioni (mm) Dimensions (mm)		
			d	F	B
15	IR -	13.5	15	20	13
	IR -	14.7	15	20	14
	IR -	24.4	15	20	23
17	IR -	10.7	17	20	16
	IR LR	11.1	17	20	16.5
	IR -	13.5	17	20	20
	IR LR	13.8	17	20	20.5
	IR LR	20.6	17	20	30.5
	IR -	14.3	17	21	16
	IR -	18	17	21	20
	IR -	14.9	17	22	13
	IR -	16.4	17	22	14
	IR -	18.7	17	22	16
	IR -	23	17	22	20
20	IR -	27.1	17	22	23
	IR -	33.6	17	24	20
	IR -	16.5	20	24	16
	IR -	21.3	20	24	20
	- LR	16.3	20	25	12.5
	□ IR -	21.1	20	25	16
	- LR	21.7	20	25	16.5
	IR -	22.4	20	25	17
	□ IR -	24.3	20	25	18
	IR -	27.5	20	25	20
	IR LR	28.2	20	25	20.5
IR LR	36.1	20	25	26.5	
IR -	40.9	20	25	30	
IR LR	52.5	20	25	38.5	
IR -	45.2	20	28	20	
22	IR -	17.5	22	26	16
	IR -	23.2	22	26	20
	IR -	29.8	22	28	17
	IR -	35	22	28	20
	IR LR	36	22	28	20.5
25	IR -	54.4	22	28	30
	IR -	25.5	25	29	20
	IR -	39.3	25	29	30
	- LR	20	25	30	12.5
	□ IR -	26	25	30	16
- LR	26.7	25	30	16.5	

□ Foro di lubrificazione di serie - With lubrication hole.

Dove non indicato disponibili a richiesta anche con foro di lubrificazione - Where it is not specified, under request available also with lubrication hole

1) Media tra diametro maggiore e minore - Average between bigger and smaller diameter.

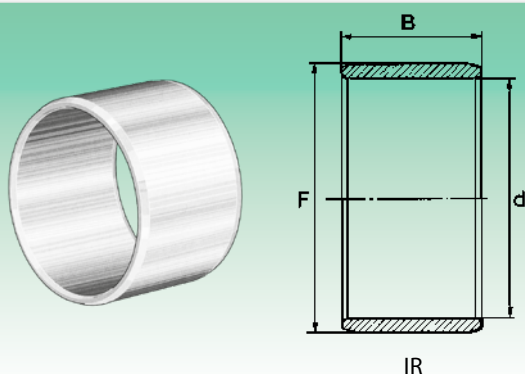
Anelli interni (serie IR • LR)
Inner rings (IR • LR series)

IR

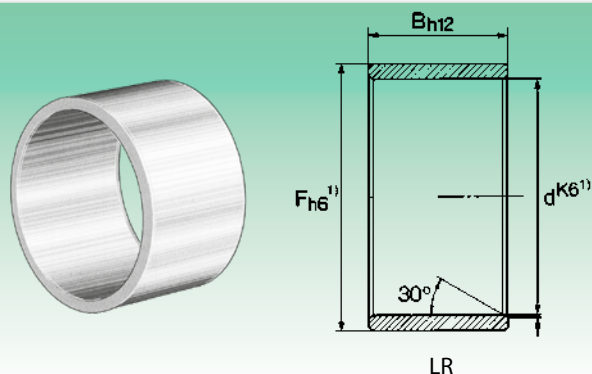

LR

Diametro albero (mm) Shaft diameter (mm)	Sigla Designation	Peso (g) Weight (g)	Dimensioni (mm) Dimensions (mm)		
			d	F	B
25	IR -	27.5	25	30	17
	IR -	29.8	25	30	18
	IR -	32.6	25	30	20
	IR LR	33.5	25	30	20.5
	IR LR	43.3	25	30	26.5
	IR -	50.1	25	30	30
	IR -	53	25	30	32
	IR LR	63.8	25	30	38.5
28	IR -	51.7	25	32	22
	IR -	24.5	28	32	17
	IR -	28.4	28	32	20
29	IR -	43.8	28	32	30
	IR -	14.8	29	32	13
30	- LR	23.3	30	35	12.5
	IR -	25	30	35	13
	IR -	30.8	30	35	16
	- LR	31.4	30	35	16.5
	IR -	32.3	30	35	17
	IR -	35.3	30	35	18
	IR -	40	30	35	20
	IR LR	40.7	30	35	20.5
	IR -	50.3	30	35	26
	IR -	54	30	35	27.5
	IR -	58.9	30	35	30
	IR -	50	30	37	18
	IR -	60.8	30	37	22
□ IR -	64.8	30	38	20	
32	IR -	42	32	37	20
	IR -	62.7	32	37	30
	IR -	68	32	40	20
	IR -	124	32	40	36
33	IR -	21.9	33	37	13
35	IR LR	27.2	35	40	12.5
	- LR	37.4	35	40	16.5
	IR -	38.3	35	40	17
	IR -	44.4	35	40	20
	IR LR	46.1	35	40	20.5
	IR -	67.9	35	40	30
35	IR -	91	35	40	40

Diametro albero (mm) Shaft diameter (mm)	Sigla Designation	Peso (g) Weight (g)	Dimensioni (mm) Dimensions (mm)			
			d	F	B	
35	□ IR -	63.9	35	42	20	
	IR -	66	35	42	20.5	
	IR -	67.7	35	42	21	
	□ IR -	74	35	42	23	
	IR -	117	35	42	36	
	IR -	82	35	43	22	
38	IR -	48.1	38	43	20	
	IR -	73.6	38	43	30	
40	- LR	41.4	40	45	16.5	
	IR -	42.5	40	45	17	
	IR -	50.5	40	45	20	
	IR LR	52.5	40	45	20.5	
	IR -	77.1	40	45	30	
	IR -	101	40	45	40	
	IR -	92.3	40	48	22	
	IR -	97.3	40	48	23	
	IR -	170	40	48	40	
	□ IR -	106	40	50	20	
42	IR -	118	40	50	22	
	IR -	53.5	42	47	20	
45	IR -	81	42	47	30	
	- LR	58.8	45	50	20.5	
	IR -	71.1	45	50	25	
	IR LR	73.7	45	50	25.5	
	IR -	101	45	50	35	
	IR -	89	45	52	22	
	IR -	93	45	52	23	
	IR -	164	45	52	40	
	□ IR -	117	45	55	20	
	IR -	130	45	55	22	
	50	□ IR -	62.6	50	55	20
		- LR	64.1	50	55	20.5
IR -		77.8	50	55	25	
IR -		112	50	55	35	
IR -		115	50	58	22	
IR -		119	50	58	23	
IR -		209	50	58	40	
□ IR -		129	50	60	20	
IR -		163	50	60	25	
IR -		183	50	60	28	

□ Foro di lubrificazione di serie - With lubrication hole.

Dove non indicato disponibili a richiesta anche con foro di lubrificazione - Where it is not specified, under request available also with lubrication hole

1) Media tra diametro maggiore e minore - Average between bigger and smaller diameter.

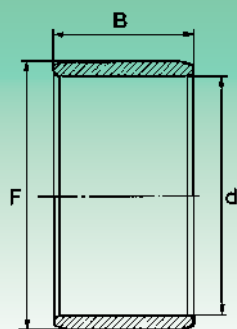
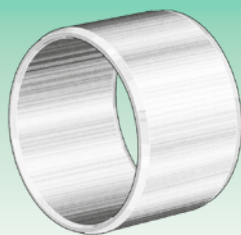

IR

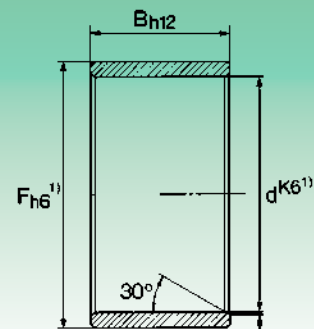
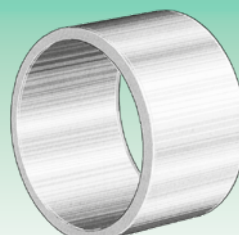

LR

Diametro albero (mm) Shaft diameter (mm)	Sigla Designation	Peso (g) Weight (g)	Dimensioni (mm) Dimensions (mm)		
			d	F	B
55	IR -	86	55	60	25
	IR -	121	55	60	35
	IR -	141	55	63	25
	IR -	256	55	63	45
	IR -	198	55	65	28
60	IR -	152	60	68	25
	IR -	213	60	68	35
	IR -	275	60	68	45
	IR -	195	60	70	25
	IR -	216	60	70	28
65	IR -	496	60	70	60
	IR -	142	65	72	25
	IR -	259	65	72	45
	IR -	164	65	73	25
	IR -	232	65	73	35
70	IR -	99	65	75	12
	IR -	230	65	75	28
	IR -	224	70	80	25
	IR -	253	70	80	28
	IR -	267	70	80	30
75	IR -	313	70	80	35
	IR -	487	70	80	54
	IR -	506	70	80	56
	IR -	548	70	80	60
	IR -	238	75	85	25
80	IR -	287	75	85	30
	IR -	336	75	85	35
	IR -	520	75	85	54
	IR -	254	80	90	25
85	IR -	304	80	90	30
	IR -	355	80	90	35
	IR -	550	80	90	54
	IR -	280	85	95	26
90	IR -	390	85	95	36
	IR -	580	85	100	35
	IR -	1 050	85	100	63
	IR -	294	90	100	26
IR -	340	90	100	30	

Diametro albero (mm) Shaft diameter (mm)	Sigla Designation	Peso (g) Weight (g)	Dimensioni (mm) Dimensions (mm)		
			d	F	B
90	IR -	406	90	100	36
	IR -	610	90	105	35
	IR -	1 110	90	105	63
95	IR -	313	95	105	26
	IR -	430	95	105	36
	IR -	643	95	110	35
100	IR -	1 170	95	110	63
	IR -	370	100	110	30
	IR -	505	100	110	40
110	IR -	775	100	115	40
	IR -	409	110	120	30
	IR -	690	110	120	40
120	IR -	840	110	125	40
	IR -	442	120	130	30
	IR -	815	120	135	35
130	IR -	1 000	120	135	45
	IR -	855	130	145	35
	IR -	1 690	130	150	50
140	IR -	412	140	155	32
	IR -	917	140	155	35
	IR -	1 800	140	160	50
150	IR -	1 120	150	165	40
160	IR -	1 200	160	175	40
170	IR -	1 450	170	185	45
180	IR -	1 510	180	195	45
190	IR -	2 410	190	210	50
200	IR -	2 490	200	220	50
220	IR -	2 750	220	240	50
240	IR -	4 600	240	265	60
260	IR -	4 980	260	285	60
280	IR -	6 100	280	305	69
300	IR -	9 200	300	330	80
320	IR -	9 800	320	350	80
340	IR -	10 200	340	370	80
360	IR -	10 900	360	390	80
380	IR -	17 000	380	415	100

□ Foro di lubrificazione di serie - With lubrication hole.

Dove non indicato disponibili a richiesta anche con foro di lubrificazione - Where it is not specified, under request available also with lubrication hole

1) Media tra diametro maggiore e minore - Average between bigger and smaller diameter.



RUOTE LIBERE AD ASTUCCIO

DRAWN CUP ROLLER CLUTCHES

RUOTE LIBERE AD ASTUCCIO CON SUPPORTO

DRAWN CUP ROLLER CLUTCHES WITH BEARINGS ASSEMBLY

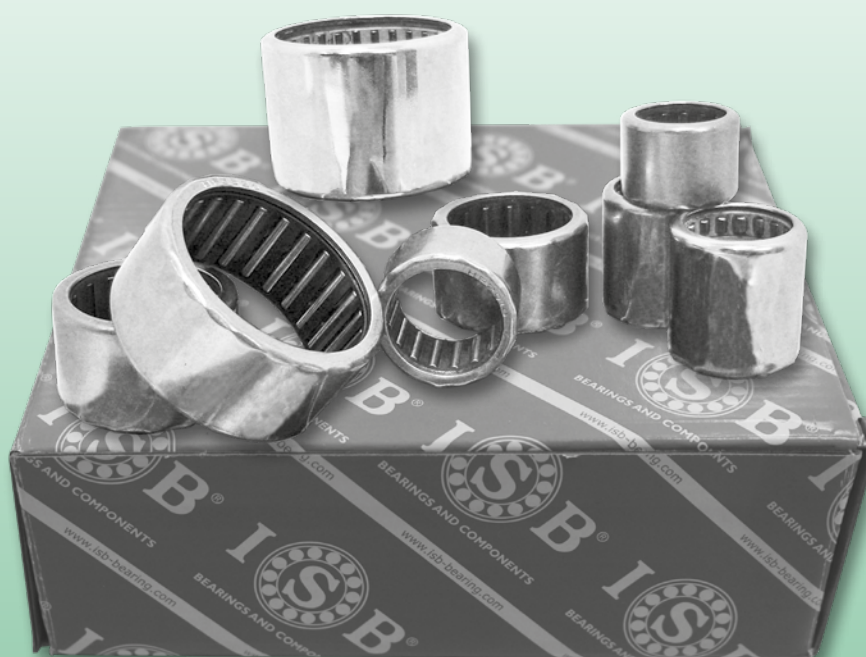



Ruote libere ad astuccio - Drawn cup roller clutches



Ruote libere ad astuccio con supporto - Drawn cup roller clutches with bearing assembly

Le ruote libere ad astuccio hanno come caratteristica principale il minimo ingombro radiale, possono trasmettere elevati momenti torcenti e permettono di realizzare dei gruppi compatti.

Sono composte da un anello esterno con parete sottile e da elementi di bloccaggio (rullini) che vengono trattenuti e guidati da molle, ed hanno il vantaggio di garantire un contatto costante tra l'albero i rullini e le superfici di bloccaggio. Questo crea il presupposto di un'elevata precisione d'innesto, anche se occorre tenere presente altri fattori come lubrificazione, tolleranze, frequenza d'innesto ecc. Per facilitare il montaggio delle ruote libere è necessario praticare uno smusso sia sull'alloggiamento che sull'albero. Le molle che trattengono i rullini possono essere costruite sia con materiale plastico che in acciaio, chiaramente se sono in plastica si possono raggiungere delle temperature d'esercizio più limitate, da -10° C. a +60° C., mentre se sono in acciaio si possono oltrepassare arrivando fino a -30°C. e +80°C. Le ruote con molle in acciaio sono indicate per applicazioni dove siano previste elevate frequenze d'innesto, tenendo ben presente di non sovraccaricare la ruota libera. Sull'astuccio viene indicato il senso di bloccaggio. Le ruote libere vengono fornite già lubrificate con grasso e trovano il loro impiego in molteplici applicazioni. Si ricorda inoltre che se viene utilizzato l'albero come pista di rotolamento, andrà rettificato e portato ad una durezza il più possibile vicino a quella dei rullini per avere così la possibilità di sfruttare al massimo la velocità di rotazione e la durata. Solitamente la prima lubrificazione è sufficiente per tutta la durata di utilizzo della ruota libera; nel caso che ci fosse necessità di un ulteriore ingrassaggio può essere eseguito senza problema alcuno. Si consiglia per il montaggio di utilizzare apposito attrezzo forzando la ruota libera nella sede e facendo attenzione al senso di bloccaggio.

Le ruote libere **HF** sono in grado di trasmettere solamente dei momenti torcenti, quindi le forze radiali devono essere supportate da cuscinetti aggiuntivi.

Per ciò che riguarda le ruote libere con supporti **HFL** occorre che ciascun lato della ruota sia integrato con cuscinetti radiali, per avere quindi la possibilità di assorbire forze radiali. Al variare della dimensione dell'albero varia il tipo di cuscinetto che si può utilizzare (o a strisciamento o a rotolamento).

Tipologie ruote libere - Drawn cup roller clutches types

Tipo-Type	Caratteristiche-Characteristics
HF	Con molle in acciaio - <i>With steel springs</i>
HF..R	Con molle in acciaio e zigrinatura - <i>With steel springs and additional knurling</i>
HF..KF	Con molle in plastica - <i>With plastic springs</i>
HF..KFR	Con molle in plastica e zigrinatura - <i>With plastic springs and additional knurling</i>
HFL	Con molle in acciaio, cuscinetti ai due lati (cuscinetti a strisciamento o volventi) <i>With steel springs, plain or rolling bearings on both sides</i>
HFL..R	Con molle in acciaio, cuscinetti ai due lati (cuscinetti a strisciamento o volventi) e zigrinatura <i>With steel springs, plain or rolling bearings on both sides, with additional knurling</i>
HFL..KF	Con molle in plastica, cuscinetti ai due lati (cuscinetti a strisciamento o volventi) <i>With plastic springs, plain or rolling bearings on both sides</i>
HFL..KFR	Con molle in plastica, cuscinetti ai due lati (cuscinetti a strisciamento o volventi) e zigrinatura <i>With plastic springs, plain or rolling bearings on both sides, with additional knurling</i>

Drawn cup roller clutches, thanks to their minimum radial dimension, are able to transmit high torque movements and to realise compact units.

They are formed by a thin outer ring and by some clamping elements (needle rollers): these latter are guided and kept from springs and have the advantage to guarantee a constant contact among the shaft, the needle bearings and locking surfaces.

This creates the presupposition to reach a very high coupling precision, even if some other important factors such as lubrication, tolerances, frequency of coupling must be considered.

To facilitate the mounting of drawn cup roller clutches and bearing assemblies, a chamfer on both housing and shaft must be done.

The springs keeping needle rollers can be made of steel or plastic, temperature suggested for plastic ones from -10°C. to +60°C. for steel ones from -30°C. to +80°C. Drawn cup roller clutches with steel springs are indicated for applications requiring frequent coupling operations, overloading are not allowed.

Direction locking is indicated on the drawn cup: ISB drawn cup roller bearings are supplied lubricated with grease and can be used in many different applications.

Shaft can be used as raceway: it must be grinded and its hardness has to be closed to needle roller one's: in this way both speed rotations and duration are at the maximum.

Usually the first lubrication lasts for all drawn cup roller clutches life, but a further lubrication can be done without any problem.

Drawn cup roller clutches are mounted by an appropriate tool with a simple press fit in their housings, particular attention has to be paid to direction locking.

HF drawn cup roller clutches transmit only torque movements: radial forces, therefore, have to be supported by using further bearings

Concerning drawn cup roller clutches with HFL support, both sides of them have to be mounted with radial bearings as they are able to stand radial forces.

When the dimension of the shaft changes, the type of bearing to use is different it can be sliding or rolling.

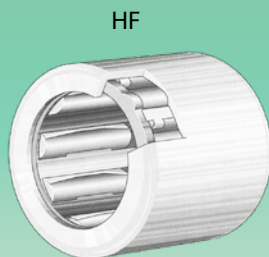

HF

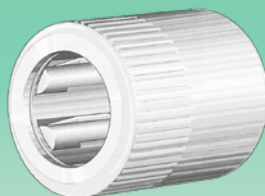

HF..R

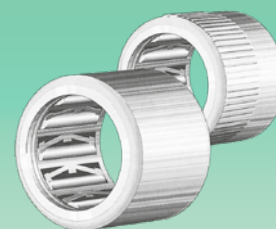

HF..KF-HF..KFR

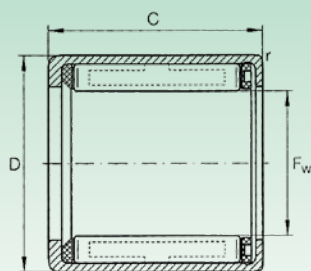

HF - HF..KF

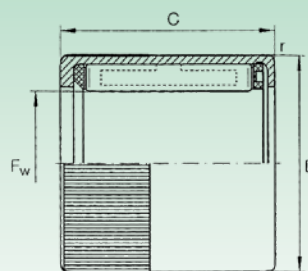
 HF..R - HF..KFR con zigrinatura
 HF..R - HF..KFR with additional knurling

Diametro albero (mm) Shaft Diameter (mm)	Sigla Designation		Peso (g) Weight (g)	Dimensioni (mm) Dimensions (mm)				Torsione Torque M_{dam} Nm	Velocità limite ¹⁾ Limiting speed		Astucci a rullini utilizzabili come supporto radiale Suitable drawn cup needle roller bearing
	Molla in acciaio Steel Spring	Molla in plastica Plastic Spring		Fw	D	C -0,3	r min.		n_{GW}^2 min ⁻¹	n_{GA}^3 min ⁻¹	
3	-	HF 0306 KF	1	3	6.5	6	0.3	0.18	45 000	8 000	HK 0306 TN
	-	HF 0306 KFR	1	3	6.5	6	0.3	0.06	45 000	8 000	HK 0306 TN
4	-	HF 0406 KF	1	4	8	6	0.3	0.34	34 000	8 000	HK 0408
	-	HF 0406 KFR	1	4	8	6	0.3	0.1	34 000	8 000	HK 0408
6	HF 0612	HF 0612 KF	3	6	10	12	0.3	1.76	23 000	13 000	HK 0608
	HF 0612 R	HF 0612 KFR	3	6	10	12	0.3	0.6	23 000	13 000	HK 0608
8	HF 0812	HF 0812 KF	3.5	8	12	12	0.3	3.15	17 000	12 000	HK 0808
	HF 0812 R	HF 0812 KFR	3.5	8	12	12	0.3	1	17 000	12 000	HK 0808
10	HF 1012	HF 1012 KF	4	10	14	12	0.3	5.3	14 000	11 000	HK 1010
12	HF 1216	-	11	12	18	16	0.3	12.2	11 000	8 000	HK 1212
14	HF 1416	-	13	14	20	16	0.3	17.3	9 500	8 000	HK 1412
16	HF 1616	-	14	16	22	16	0.3	20.5	8 500	7 500	HK 1612
18	HF 1816	-	16	18	24	16	0.3	24.1	7 500	7 500	HK 1812
20	HF 2016	-	17	20	26	16	0.3	28.5	7 000	6 500	HK 2010
25	HF 2520	-	30	25	32	20	0.3	66	5 500	5 500	HK 2512
30	HF 3020	-	36	30	37	20	0.3	90	4 500	4 500	HK 3012
35	HF 3520	-	40	35	42	20	0.3	121	3 900	3 900	HK 3512

1) I numeri di giri limite valgono per lubrificazione a grasso e ad olio - Number of limiting revolutions are valid for both grease and oil lubrication.

2) Numero di giri limite per albero rotante - Number of limiting revolutions for rotating shaft.

3) Numero di giri limite per anello esterno rotante - Number of limiting revolutions for outer rotating ring.

Ulteriori misure in esecuzione speciale disponibili solo su specifica richiesta - Other sizes in special executions (available only under request)

Ruote libere ad astuccio con supporti (serie HFL - HFL..KF - HFL..R - HFL..KFR)
Drawn cup roller clutches with bearing assemblies (HFL - HFL..KF - HFL..R - HFL..KFR series)

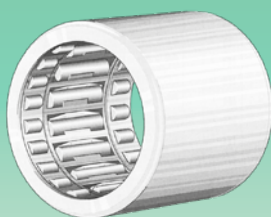
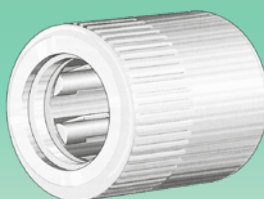
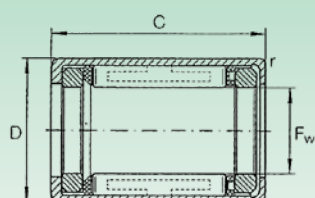
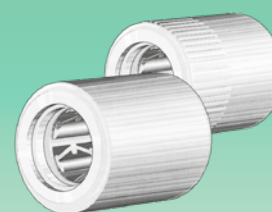
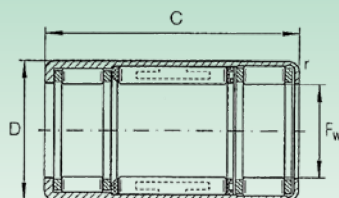
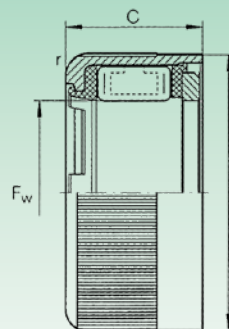
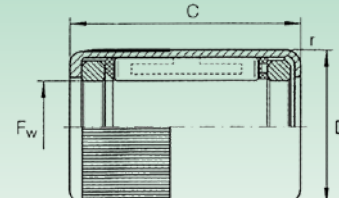
HFL

HFL..R

HFL...KF-HFL..KFR

 HFL, HFL..KF con cuscinetto strisciante
 HFL, HFL..KF with plain bearing

 HFL, HFL..KF con cuscinetto volante
 HFL, HFL..KF with rolling bearing

 HFL 06 06 KFR
 HFL 08 06 KFR
 senza freccia sul lato frontale
 no arrow on the front
 con zigrinatura
 with additional knurling

 HFL 04 08 KFR
 HFL 06 15 KFR
 con zigrinatura
 with additional knurling

Diametro albero (mm) Shaft Diameter (mm)	Sigla Designation		Peso (g) Weight (g)	Dimensioni (mm) Dimensions (mm)				Torsione Torgue M _{d amm} Nm	Velocità limite ¹⁾ Limiting speed		Coefficienti di carico Basic load ratings	
	Molla in acciaio Steel Spring	Molla in plastica Plastic Spring		F _w	D	C -0,3	r min.		n _{GW} ²⁾ min ⁻¹	n _{GA} ³⁾ min ⁻¹	din. C dyn. C N	stat. Co stat. Co N
3	-	HFL 0308 KF	1.4	3	6.5	8	0.3	0.18	45 000	8 000	-	-
	-	HFL 0308 KFR	1.4	3	6.5	8	0.3	0.06	45 000	8 000	-	-
4	-	HFL 0408 KF	1.6	4	8	8	0.3	0.34	34 000	8 000	-	-
	-	HFL 0408 KFR	1.6	4	8	8	0.3	0.1	34 000	8 000	-	-
6	-	HFL 0606 KFR	1	6	10	6	0.3	0.5	23 000	13 000	-	-
	-	HFL 0615	4	6	10	15	0.3	1.76	23 000	13 000	-	-
	-	HFL 0615 R	4	6	10	15	0.3	0.60	23 000	13 000	-	-
8	-	HFL 0806 KFR	2	8	12	6	0.3	0.7	17 000	12 000	-	-
	-	HFL 0822	7	8	12	22	0.3	3.15	17 000	12 000	3 650	3 950
	-	HFL 0822 R	7	8	12	22	0.3	1	17 000	12 000	3 650	3 950
10	-	HFL 1022	8	10	14	22	0.3	5.3	14 000	11 000	3 950	4 500
12	-	HFL 1226	18	12	18	26	0.3	12.2	11 000	8 000	6 300	6 700
14	-	HFL 1426	20	14	20	26	0.3	17.3	9 500	8 000	6 800	7 800
16	-	HFL 1626	22	16	22	26	0.3	20.5	8 500	7 500	7 400	9 000
18	-	HFL 1826	25	18	24	26	0.3	24.1	7 500	7 500	8 000	10 200
20	-	HFL 2026	27	20	26	26	0.3	28.5	7 000	6 500	8 500	11 400
25	-	HFL 2530	44	25	32	30	0.3	66	5 500	5 500	10 600	14 000
30	-	HFL 3030	51	30	37	30	0.3	90	4 500	4 500	11 600	16 900
35	-	HFL 3530	58	35	42	30	0.3	121	3 900	3 900	12 200	18 800

1) I numeri di giri limite valgono per lubrificazione a grasso e ad olio - Number of limiting revolutions are valid for both grease and oil lubrication.

2) Numero di giri limite per albero rotante - Number of limiting revolutions for rotating shaft.

3) Numero di giri limite per anello esterno rotante - Number of limiting revolutions for outer rotating ring.

Ulteriori misure in esecuzione speciale disponibili solo su specifica richiesta - Other sizes in special executions (available only under request)





CUSCINETTI ASSIALI A RULLI CILINDRICI

AXIAL CYLINDRICAL ROLLER BEARINGS





**Cuscinetti assiali a rulli cilindrici****Axial cylindrical roller bearings**

I cuscinetti assiali a rulli cilindrici sono costituiti da una gabbia assiale a rulli cilindrici e da una ralla di tipo GS per alloggiamento e da una ralla di tipo WS per albero. Solitamente vengono utilizzati i cuscinetti assiali a rulli cilindrici quando i cuscinetti assiali a rullini non sono più in grado di sopportare carichi assiali elevati.

Le tolleranze dimensionali corrispondono alla classe di tolleranza PO, ma su espressa richiesta della clientela possono essere forniti cuscinetti assiali a rulli cilindrici e ralle per cuscinetti assiali della serie WS, GS e ZS con classe di tolleranza P5 e P6.

Cuscinetti assiali a rullini con bordo di centraggio nella ralla assiale.

Le componenti principali dei cuscinetti assiali a rullini della serie AXW sono una gabbia assiale a rullini AXK ed una ralla AS. Possono essere combinati con diverse ralle per cuscinetti assiali del tipo AS, LS e WS, bussole, astucci a rullini e cuscinetti a rullini.

Gabbie assiali

Le gabbie assiali sono composte da una struttura che ha il compito principale di trattenere e guidare i rullini con elevata precisione. Le gabbie a rullini presentano il vantaggio di avere un ingombro molto ridotto, ancor più se possono utilizzare le superficie adiacenti come pista di rotolamento e comunque in caso contrario sono fornibili completi di gabbia e ralle.

Gabbie assiali a rullini

La gabbia assiale AXK è l'elemento principale che forma i cuscinetti assiali a rullini che sono disposti in modo radiale. È proprio grazie alla gabbia ed ai rullini che si muovono con precisione ottenendo una distribuzione omogenea dei carichi. Le gabbie assiali possono raggiungere un elevato numero di giri, e normalmente possono combinarsi con ralle del tipo AS, GS, WS, LS e ZS.

Gabbie assiali a rulli cilindrici

Le gabbie assiali a rulli cilindrici K hanno una struttura più robusta e possono essere costruite con materiale plastico, in leghe leggere ed ottone. Le gabbie assiali a rulli cilindrici possono accoppiarsi con ralle per alloggiamento di tipo GS e con ralle per albero di tipo WS. Le gabbie assiali a rulli cilindrici appartenenti alla serie K 811 possono accoppiarsi anche con ralle di tipo AS, LS e ZS.

Ralle per cuscinetti assiali

Le ralle AS sono costruite in acciaio di buona qualità, sono lappate ed hanno uno spessore di circa 1 mm. Solitamente vengono utilizzate sia come ralle per alloggiamento che come ralle per albero, in combinazione con le gabbie assiali a rullini della serie AXK e con le gabbie assiali a rulli cilindrici della serie K811.

Axial roller bearings are assembled with an axial roller cage, with a GS housing piloted washer and with a WS shaft piloted washer.

Usually axial roller bearings are required when axial needle bearings are not able to stand heavier axial loads.

Dimensional tolerances are of PO precision class, but under request axial roller bearings and thrust washers for axial bearings of WS, GS and ZS series, can be supplied with P5 and P6 precision tolerance.

Axial needle roller bearings with centring spigot on the bearing washer

The most important components for AXW axial needle bearings are an AXK axial needle roller bearing and cage assembly and an AS thrust washer. They can also be combined with some other washers for axial bearings such as, AS, LS, WS, sleeves, needle bearings and drawn cup needle roller bearings.

Axial needle roller and cage assemblies

Axial roller and cage assemblies are fitted with a particular structure which enables them to keep and drive the needle rollers with a very high degree of precision.

Their dimensions are reduced and they could be even smaller if they could use the adjacent cluttered surfaces as raceway, otherwise they can be fitted with axial bearing washers and cage.

Axial needle roller and cage assemblies

Axial needle roller and cage assembly, are fitted with axial cages: thanks to this cage and thanks to the rollers moving with precision, loads are homogeneously distributed.

AXK are able to reach very high speeds and can be combined with AS, GS, WS, LS and ZS axial bearing washers.

Axial cylindrical roller and cage assemblies

K axial cylindrical rollers and cage assemblies have a stronger structure and can be manufactured with plastic, light alloys and brass material.

They can be assembled with GS housing locating washers WS shaft locating washers, AS, LS and ZS.

Axial bearing washers

AS axial bearing washers are made of a good quality steel, lapped and have a thickness of about 1 mm.

They can be used as shaft or housing locating washers, suitable for AXK and K811 assemblies.



**Cuscinetti assiali a rulli cilindrici*****Axial cylindrical roller bearings*****Ralle per alloggiamento e per albero**

Le ralle appartenenti a questo gruppo (GS e WS) sono ralle di tipo massiccio, prodotte in acciaio per cuscinetti volventi. Le superfici di rotolamento sono lappate, mentre le superfici esterne della ralla per alloggiamento sono rettificate.

Ralle per cuscinetti assiali

Le ralle di tipo LS appartengono alla linea più economica in quanto solitamente vengono utilizzate quando non si ha necessità di elevata precisione, possono essere impiegate sia come ralle di alloggiamento che come ralle per albero. Le piste volventi delle ralle sono rettificate e possono essere combinate con le gabbie assiali a rullini della serie AXK ed a rulli cilindrici della serie K 811.

Ralle intermedie

Le ralle di tipo intermedio ZSI e ZSE sono ideali per ottenere combinazioni di cuscinetti assiali a doppio effetto con l'impiego di ralle di alloggiamento GS e ralle per albero WS. Possono essere montate tra due gabbie a rullini di tipo AXK o a rulli cilindrici della serie K 811.

Housing and shaft locating washers

These kinds of washers are made of hardened rolling bearing steel, GS and WS belong to a massive washers. Running surfaces are lapped, outer surfaces of housing washers are grinded.

Axial bearing washers

LS axial bearing washers belong to the most economical line as they are usually mounted when high precision is not required; they can be used as housing washers or as shaft washers. LS axial bearing washers have grinded raceways that can be combined with AXK Axial thrust needle roller and cage assemblies and with K 811 axial cylindrical roller and cage assemblies.

Intermediate washers

ZSI and ZSE intermediate washers are the most indicated double effect axial bearing by using housing (GS) and shaft (WS) locating washers. They can be mounted with two AXK axial needle roller and cage assemblies or with K 811 axial cylindrical roller and cage assemblies.



Tipologie dei cuscinetti assiali a rullini ed a rulli cilindrici

Axial needle and cylindrical roller bearings types

Tipo-Type	Caratteristiche-Characteristics
AXW	Cuscinetto assiale a rullini, formato da AXK e AS con bordo di centraggio, combinabile con diverse tipologie di ralle per cuscinetti assiali, bussole, astucci e cuscinetti a rullini. <i>Axial needle bearings, composed by AXK and AS with centering spigot, can be combined with different types of axial bearing washers, bushes, drawn cups and needle bearings.</i>
811-812	Cuscinetti assiali a rulli cilindrici, formati da K 811 o 812 con GS o WS (adatti per carichi assiali elevati) <i>Axial cylindrical roller bearings, composed by K 811 or 812 with GS or WS (suitable for high axial loads)</i>
893-894	Cuscinetti assiali a rulli cilindrici, formati da K 893 o 894 con GS o WS (adatti per carichi assiali elevatissimi) <i>Axial cylindrical roller bearings, composed by K 893 or 894 with GS or WS (suitable for the highest axial loads)</i>

Tipologie delle gabbie assiali a rullini ed a rulli cilindrici

Axial needle cylindrical roller and cage assemblies types

Tipo-Type	Caratteristiche-Characteristics
AXK	Gabbia assiale a rullini, combinabile con diverse tipologie di ralle per cuscinetti assiali. <i>Axial needle roller and cage assembly, that can be combined with different types of axial bearing washers.</i>
K 811-812	Gabbie assiali a rulli cilindrici, ad una corona, combinabili con diverse tipologie di ralle per cuscinetti assiali. <i>Axial cylindrical roller and cage assemblies with one crown, that can be combined with different types of axial bearing washers.</i>
K 893-894	Gabbie assiali a rulli cilindrici, a due corone, combinabili con diverse ralle per cuscinetti assiali. <i>Axial cylindrical roller and cage assemblies with two crowns, that can be combined with different axial bearing washers.</i>

Types de rondelles pour butées

Axial bearings washers type

Tipo-Type	Caratteristiche-Characteristics
AS	Ralla assiale, utilizzabile come ralla per albero e per alloggiamento, adatta a AXK e K 811 <i>Axial bearings washer, used as a housing and shaft locating washer, suitable for AXK and K 811</i>
GS	Ralla per alloggiamento, centraggio esterno <i>Housing locating washer, with outer centering</i>
WS	Ralla per albero, centraggio interno <i>Shaft locating washer, with inner centering</i>
LS	Ralla assiale, utilizzabile come ralla per albero e per alloggiamento, adatta a AXK e K 811 (minor precisione) <i>Axial bearing washer, used as a shaft and housing locating washer, suitable for AXK and K 811 (lower precision)</i>
ZSI - ZSE	Ralla intermedia con centraggio interno ed esterno, utilizzabile combinata con cuscinetti assiali a doppio effetto, adatta a AXK e K811 <i>Intermediate washer with inner and outer centering, can be used if combined with double effect axial bearings, suitable for AXK and K811</i>

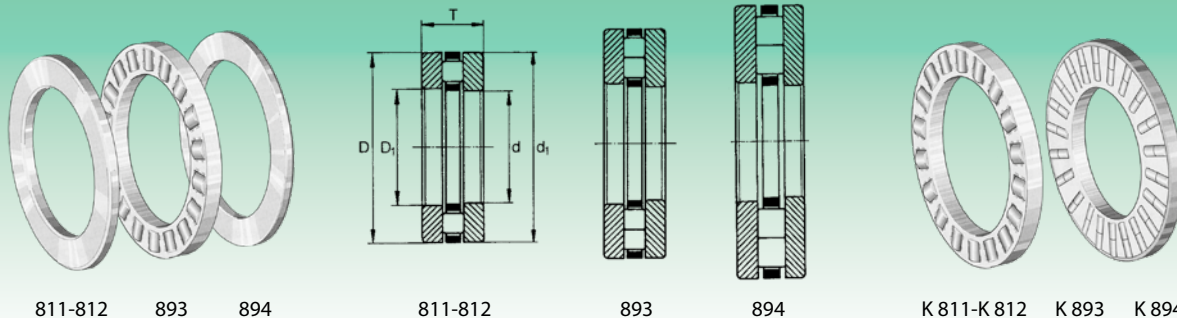

Cuscinetti assiali a rulli cilindrici Axial cylindrical roller bearings					Gabbie assiali a rulli cilindrici Axial cylindrical roller		Ralle per cuscinetti assiali Axial bearing washers				
Diametro albero (mm) Shaft diameter (mm)	Sigla - Designation				Peso (g) Weight (g)	Sigla Designation	Peso (g) Weight (g)	Ralle per alloggiamento Housing locating washers	Ralle per albero Shaft locating washers	Ralle di rotolamento Bearing washers	Peso (g) Weight (g)
	Serie 811 811 Series	Serie 812 812 Series	Serie 893 893 Series	Serie 894 894 Series							
15	811 02 TN				24	K811 02 TN	6	GS811 02	WS811 02	LS1528	8
17	811 03 TN				27	K811 03 TN	9	GS811 03	WS811 03	LS1730	9
20	811 04 TN				37	K811 04 TN	13	GS811 04	WS811 04	LS2035	12
25	811 05 TN				53	K811 05 TN	15	GS811 05	WS811 05	LS2542	19
30	811 06 TN				57	K811 06 TN	17	GS811 06	WS811 06	LS3047	20
		812 06 TN			123	K812 06 TN	33	GS812 06	WS812 06	—	45
			893 06 TN		240	K893 06 TN	40	GS893 06	WS893 06	—	95
35	811 07 TN				73	K811 07 TN	19	GS811 07	WS811 07	LS3552	27
		812 07 TN			195	K812 07 TN	43	GS812 07	WS812 07	—	76
			893 07 TN		340	K893 07 TN	53	GS893 07	WS893 07	—	134
40	811 08 TN				105	K811 08 TN	31	GS811 08	WS811 08	LS4060	37
		812 08 TN			249	K812 08 TN	81	GS812 08	WS812 08	—	84
			893 08 TN		484	K893 08 TN	98	GS893 08	WS893 08	—	193
45	811 09 TN				130	K811 09 TN	35	GS811 09	WS811 09	LS4565	47
		812 09 TN			287	K812 09 TN	85	GS812 09	WS812 09	—	101
			893 09 TN		615	K893 09 TN	121	GS893 09	WS893 09	—	247
50	811 10 TN				140	K811 10 TN	38	GS811 10	WS811 10	LS5070	51
		812 10 TN			356	K812 10 TN	98	GS812 10	WS812 10	—	129
			893 10 TN		887	K893 10 TN	175	GS893 10	WS893 10	—	356
55	811 11 TN				218	K811 11 TN	45	GS811 11	WS811 11	LS5578	82
		812 11 TN			568	K812 11 TN	166	GS812 11	WS812 11	—	201
			893 11 TN		118	K893 11 TN	195	GS893 11	WS893 11	—	485
60	811 12 TN				266	K811 12 TN	82	GS811 12	WS811 12	LS6085	92
		812 12 TN			642	K812 12 TN	176	GS812 12	WS812 12	—	233
			893 12 TN		126	K893 12 TN	210	GS893 12	WS893 12	—	517
				894 12 TN	2 818	K894 12 TN	538	GS894 12	WS894 12	—	1 115



Cuscinetti assiali a rulli cilindrici (serie 811 • 812 • 893 • 894)



Axial cylindrical roller bearings (811 • 812 • 893 • 894 series)

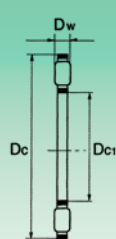

K811
K812

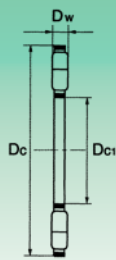

K893

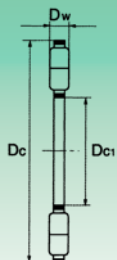

K894

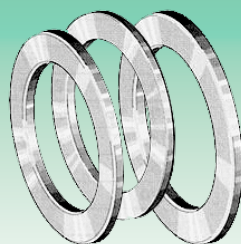

GS WS LS

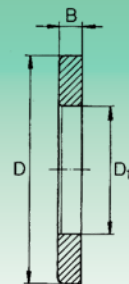

GS 811-812
893-894

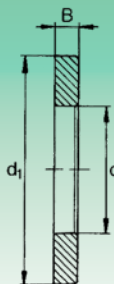

WS 811-812
893-894

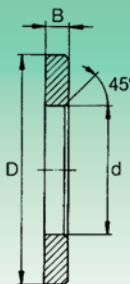

LS

Dimensioni (mm) Dimensions (mm)							Coefficienti di carico (N) Basic load ratings (N)		Velocità limite Limiting Speed
D _{c1} d	D ₁	D D _c	d ₁	T	D _w	B	Dinamico C Dynamic C	Statico C _s Static C _s	Olio (N. giri max) Oil (max rpm)
15	16	28	28	9	3.5	2.75	13 500	28 000	12 350
17	18	30	30	9	3.5	2.75	15 100	32 900	11 400
20	21	35	35	10	4.5	2.75	23 700	52 600	9 500
25	26	42	42	11	5	3	32 900	72 000	8 000
30	32	47	47	11	5	3	34 800	85 000	7 100
30	32	52	52	16	7.5	4.25	63 500	139 000	6 650
30	32	60	60	18	5.5	6.25	67 900	188 500	6 200
35	37	52	52	12	5	3.5	38 500	100 900	6 200
35	37	62	62	18	7.5	5.25	79 800	198 100	5 700
35	37	68	68	20	6	7	79 800	236 500	5 200
40	42	60	60	13	6	3.5	55 000	147 500	5 700
40	42	68	68	19	9	5	106 500	264 600	5 200
40	42	78	78	22	7	7.5	119 000	384 500	4 700
45	47	65	65	14	6	4	58 500	162 500	4 750
45	47	73	73	20	9	5.5	104 500	264 100	4 700
45	47	85	85	24	7.5	8.25	138 500	439 000	4 200
50	52	70	70	14	6	4	60 700	167 000	4 500
50	52	78	78	22	9	6.5	106 000	309 000	4 300
50	52	95	95	27	8	9.5	166 500	557 900	3 800
55	57	78	78	16	6	5	87 900	298 700	4 100
55	57	90	90	25	11	7	153 100	404 500	3 800
55	57	105	105	30	9	10.5	183 200	599 800	3 500
60	62	85	85	17	7.5	4.75	102 100	309 500	3 800
60	62	95	95	26	11	7.5	171 100	478 000	3 500
60	62	110	110	30	9	10.5	195 100	669 800	3 200
60	62	130	130	42	14	14	388 000	1 219 500	2 850



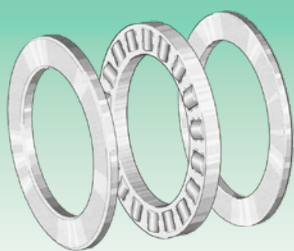

811-812 893 894

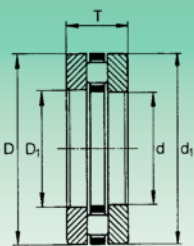

811-812



893

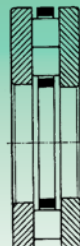

894

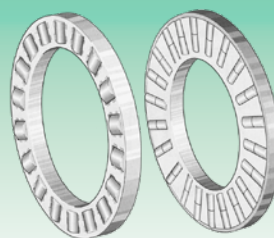

K 811-K 812 K 893 K 894

Cuscinetti assiali a rulli cilindrici Axial cylindrical roller bearings					Gabbie assiali a rulli cilindrici Axial cylindrical roller			Ralle per cuscinetti assiali Axial bearing washers			
Diametro albero (mm) Shaft diameter (mm)	Sigla - Designation				Peso (g) Weight (g)	Sigla Designation	Peso (g) Weight (g)	Ralle per alloggiamento Housing locating washers	Ralle per albero Shaft locating washers	Ralle di rotolamento Bearing washers	Peso (g) Weight (g)
	Serie 811 811 Series	Serie 812 812 Series	Serie 893 893 Series	Serie 894 894 Series							
65	811 13 TN				310	K811 13 TN	90	GS811 13	WS811 13	LS 6590	110
		812 13 TN			721	K812 13 TN	185	GS812 13	WS812 13	—	268
			893 13 TN		1 330	K893 13 TN	210	GS893 13	WS893 13	—	535
				894 13 TN	3 520	K894 13 TN	720	GS894 13	WS894 13	—	1 400
70	811 14 TN				332	K811 14 TN	92	GS811 14	WS811 14	LS 7095	120
		812 14 TN			768	K812 14 TN	212	GS812 14	WS812 14	—	278
			893 14 TN		1 820	K893 14 TN	290	GS893 14	WS893 14	—	800
				894 14 TN	4 180	K894 14 TN	920	GS894 14	WS894 14	—	1 730
75	811 15 TN				393	K811 15 TN	96	GS811 15	WS811 15	LS 75100	136
		812 15 TN			800	K812 15 TN	195	GS812 15	WS812 15	—	293
			893 15 TN		2 230	K893 15 TN	375	GS893 15	WS893 15	—	970
				894 15-M	5 250	K894 15-M	1 070	GS894 15	WS894 15	—	2 090
80	811 16 TN				400	K811 16 TN	95	GS811 16	WS811 16	LS 80105	144
		812 16 TN			900	K812 16 TN	234	GS812 16	WS812 16	—	333
			893 16 TN		2 370	K893 16 TN	420	GS893 16	WS893 16	—	1 020
				894 16-M	6 410	K894 16-M	1 410	GS894 16	WS894 16	—	2 500
85	811 17 TN				420	K811 17 TN	118	GS811 17	WS811 17	LS 85110	151
		812 17 TN			1 260	K812 17 TN	280	GS812 17	WS812 17	—	490
			893 17-M		3 000	K893 17-M	540	GS893 17	WS893 17	—	1 230
				894 17-M	7 550	K894 17-M	1 610	GS894 17	WS894 17	—	2 970
90	811 18 TN				620	K811 18 TN	150	GS811 18	WS811 18	LS 90120	225
		812 18 TN			1 770	K812 18 TN	542	GS812 18	WS812 18	—	614
			893 18-M		3 280	K893 18-M	620	GS893 18	WS893 18	—	1 330
				894 18-M	8 770	K894 18-M	1 870	GS894 18	WS894 18	—	3 450
100	811 20 TN				950	K811 20 TN	250	GS811 20	WS811 20	LS 100135	350
		812 20			2 200	K812 20	600	GS812 20	WS812 20	—	800
			893 20-M		4 190	K893 20-M	810	GS893 20	WS893 20	—	1 690
				894 20-M	11 900	K894 20-M	2 400	GS894 20	WS894 20	—	4 750



Cuscinetti assiali a rulli cilindrici (serie 811 • 812 • 893 • 894)



Axial cylindrical roller bearings (811 • 812 • 893 • 894 series)

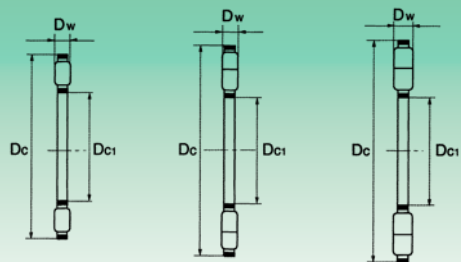

K811
K812

K893

K894

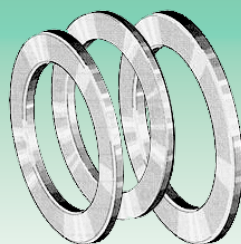

GS WS LS

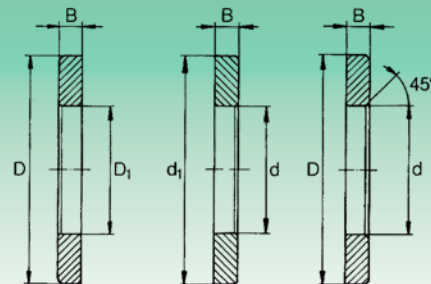

GS 811-812
893-894

WS 811-812
893-894

LS

Dimensioni (mm) Dimensions (mm)							Coefficienti di carico (N) Basic load ratings (N)		Velocità limite Limiting Speed
D _{c1} d	D ₁	D D _c	d ₁	T	D _w	B	Dinamico C Dynamic C	Statico C _s Static C _s	Olio (N. giri max) Oil (max rpm)
65	67	90	90	18	7.5	5.25	106 500	339 500	3 500
65	67	100	100	27	11	8	176 800	499 500	3 300
65	67	115	115	30	9	10.5	193 500	667 900	3 000
65	68	140	140	45	15	15	444 000	1 396 000	2 700
70	72	95	95	18	7.5	5.25	110 800	364 500	3 300
70	72	105	105	27	11	8	186 000	549 700	3 100
70	72	125	125	34	10	12	238 500	829 600	2 850
70	73	150	150	48	16	16	449 800	1 389 500	2 500
75	77	100	100	19	7.5	5.75	104 500	339 600	3 100
75	77	110	110	27	11	8	171 500	498 700	2 900
75	77	135	135	36	11	12.5	284 800	1 009 000	2 600
75	78	160	160	51	17	17	499 600	1 579 800	2 350
80	82	105	105	19	7.5	5.75	105 800	348 800	2 900
80	82	115	115	28	11	8.5	200 600	629 600	2 850
80	82	140	140	36	11	12.5	304 500	1 109 800	2 500
80	83	170	170	54	18	18	559 600	1 769 500	2 200
85	87	110	110	19	7.5	5.75	111 900	369 600	2 850
85	88	125	125	31	12	9.5	216 500	659 700	2 600
85	88	150	150	39	12	13.5	324 600	1 099 600	2 400
85	88	180	180	58	19	19.5	619 500	1 979 800	2 100
90	92	120	120	22	9	6.5	140 600	459 000	2 550
90	93	135	135	35	14	10.5	288 900	886 900	2 450
90	93	155	155	39	12	13.5	329 500	1 199 400	2 300
90	93	190	190	60	20	20	678 900	2 199 600	2 000
100	102	135	135	25	11	7	197 000	649 800	2 400
100	103	150	150	38	15	11.5	279 800	839 600	2 200
100	103	170	170	42	13	14.5	379 500	1 399 500	2 000
100	103	210	210	67	22	22.5	849 000	2 847 900	1 800



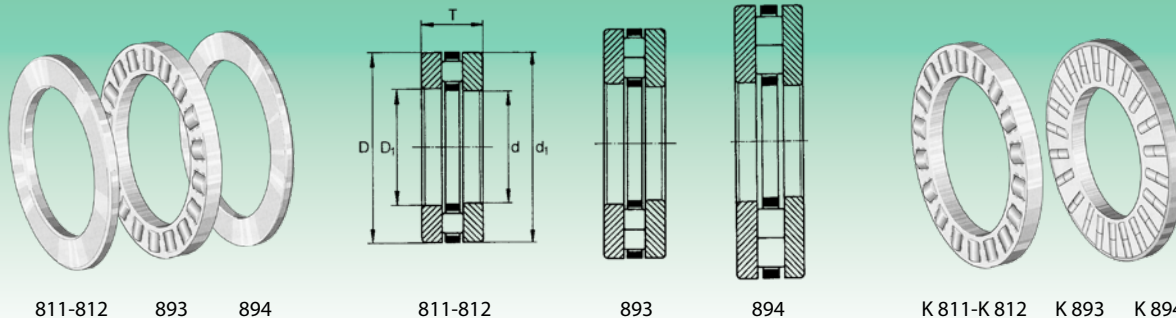

Cuscinetti assiali a rulli cilindrici <i>Axial cylindrical roller bearings</i>					Gabbie assiali a rulli cilindrici <i>Axial cylindrical roller</i>		Ralle per cuscinetti assiali <i>Axial bearing washers</i>				
Diametro albero (mm) <i>Shaft diameter (mm)</i>	Sigla - Designation				Peso (g) <i>Weight (g)</i>	Sigla <i>Designation</i>	Peso (g) <i>Weight (g)</i>	Ralle per alloggiamento <i>Housing locating washers</i>	Ralle per albero <i>Shaft locating washers</i>	Ralle di rotolamento <i>Bearing washers</i>	Peso (g) <i>Weight (g)</i>
	Serie 811 <i>811 Series</i>	Serie 812 <i>812 Series</i>	Serie 893 <i>893 Series</i>	Serie 894 <i>894 Series</i>							
110	811 22 TN				1 040	K811 22 TN	270	GS811 22	WS811 22	LS 110145	385
		812 22 TN			2 445	K812 22 TN	685	GS812 22	WS812 22	—	880
			893 22 - M		6 030	K893 22 - M	1 150	GS893 22	WS893 22	—	2 440
				894 22 - M	15 600	K894 22 - M	3 300	GS894 22	WS894 22	—	6 150
120	811 24 TN				1 170	K811 24 TN	340	GS811 24	WS811 24	LS 120155	415
		812 24 TN			2 690	K812 24 TN	730	GS812 24	WS812 24	—	980
			893 24 - M		8 520	K893 24 - M	1 720	GS893 24	WS893 24	—	3 400
				894 24 - M	19 700	K894 24 - M	4 300	GS894 24	WS894 24	—	7 700
130	811 26 TN				1 700	K811 26 TN	414	GS811 26	WS811 26	LS 130170	643
		812 26 TN			4 204	K812 26 TN	1 144	GS812 26	WS812 26	—	1 530
			893 26 - M		10 000	K893 26 - M	1 910	GS893 26	WS893 26	—	4 045
				894 26 - M	24 000	K894 26 - M	5 000	GS894 26	WS894 26	—	9 500
140	811 28 TN				1 946	K811 28 TN	448	GS811 28	WS811 28	LS 140180	749
		812 28 - M			4 567	K812 28 - M	1 197	GS812 28	WS812 28	—	1 635
			893 28 - M		11 990	K893 28 - M	2 390	GS893 28	WS893 28	—	4 800
				894 28 - M	27 200	K894 28 - M	6 000	GS894 28	WS894 28	—	10 600
150	811 30 TN				2 066	K811 30 TN	474	GS811 30	WS811 30	LS 150190	796
		812 30 - M			5 886	K812 30 TN	1 520	GS812 30	WS812 30	—	2 180
			893 30 - M		12 630	K893 30 - M	2 510	GS893 30	WS893 30	—	5 060
				894 30 - M	32 100	K894 30 - M	7 100	GS894 30	WS894 30	—	12 500
160	811 32 TN				2 189	K811 32 TN	505	GS811 32	WS811 32	LS 160200	842
		812 32 - M			6 203	K812 32 - M	1 603	GS812 32	WS812 32	—	2 300
				894 32 - M	38 200	K894 32 - M	8 600	GS894 32	WS894 32	—	14 800
170	811 34 TN				2 950	K811 34 TN	750	GS811 34	WS811 34	—	1 100
		812 34 - M			7 690	K812 34 - M	1 890	GS812 34	WS812 34	—	2 900
				894 34 - M	47 200	K894 34 - M	10 200	GS894 34	WS894 34	—	18 500

Cuscinetti assiali a rulli cilindrici (serie 811 • 812 • 893 • 894)

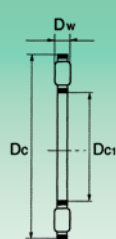
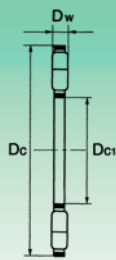
Axial cylindrical roller bearings (811 • 812 • 893 • 894 series)

 K811
K812

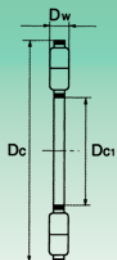
K893

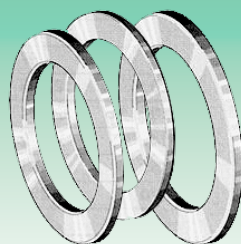

K894

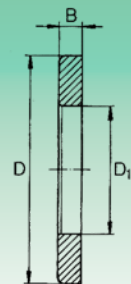
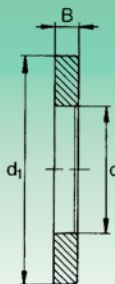
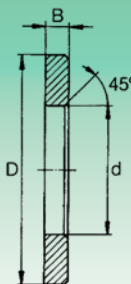

GS WS LS

 GS 811-812
893-894

 WS 811-812
893-894

LS

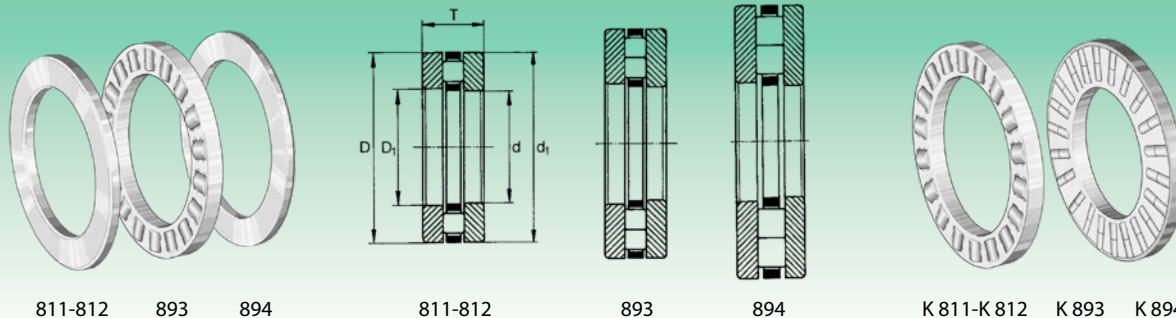
Dimensioni (mm) Dimensions (mm)							Coefficienti di carico (N) Basic load ratings (N)		Velocità limite Limiting Speed
D_{c1} d	D_1	D D_c	d_1	T	D_w	B	Dinamico C Dynamic C	Statico C_o Static C_o	Olio (N. giri max) Oil (max rpm)
110	112	145	145	25	11	7	206 850	699 200	2 200
110	113	160	160	38	15	11.5	299 800	939 700	2 000
110	113	190	190	48	15	16.5	499 500	1 867 900	1 800
110	113	230	230	73	24	24.5	998 500	3 397 800	1 600
120	122	155	155	25	11	7	202 700	698 900	2 000
120	123	170	170	39	15	12	309 600	979 600	1 900
120	123	210	210	54	17	18.5	639 500	2 417 600	1 600
120	123	250	250	78	26	26	1 159 500	3 987 900	1 500
130	132	170	170	30	12	9	232 700	809 600	1 800
130	133	190	187	45	19	13	424 500	1 287 900	1 700
130	134	225	225	58	18	20	709 600	2 697 900	1 500
130	134	270	270	85	28	28.5	1 329 700	4 599 800	1 350
140	142	180	178	31	12	9.5	241 800	865 900	1 700
140	143	200	197	46	19	13.5	444 500	1 449 700	1 600
140	144	240	240	60	19	20.5	819 700	3 198 900	1 400
140	144	280	280	85	28	28.5	1 379 600	4 949 800	1 300
150	152	190	188	31	12	9.5	249 600	929 700	1 600
150	153	215	212	50	21	14.5	589 600	1 938 900	1 500
150	154	250	250	60	19	20.5	837 900	3 347 900	1 300
150	154	300	300	90	30	30	1 569 500	5 698 900	1 200
160	162	200	198	31	12	9.5	259 600	989 600	1 500
160	163	225	222	51	21	15	599 500	2 028 900	1 400
160	164	320	320	95	32	31.5	1 778 600	6 498 800	1 100
170	172	215	213	34	14	10	324 600	1 215 700	1 400
170	173	240	237	55	22	16.5	679 900	2 339 500	1 300
170	174	340	340	103	34	34.5	1 989 900	7 399 850	1 000



Cuscinetti assiali a rulli cilindrici Axial cylindrical roller bearings					Gabbie assiali a rulli cilindrici Axial cylindrical roller		Ralle per cuscinetti assiali Axial bearing washers			
Diametro albero (mm) Shaft diameter (mm)	Sigla - Designation				Peso (g) Weight (g)	Sigla Designation	Peso (g) Weight (g)	Ralle per alloggiamento Housing locating washers	Ralle per albero Shaft locating washers	Peso (g) Weight (g)
	Serie 811 811 Series	Serie 812 812 Series	Serie 893 893 Series	Serie 894 894 Series						
180	811 36 - M				3 040	K811 36 - M	800	GS811 36	WS811 36	1 120
		812 36 - M			8 240	K812 36 - M	1 980	GS812 36	WS812 36	3 130
				894 36 - M	54 800	K894 36 - M	12 200	GS894 36	WS894 36	21 300
190	811 38 - M				3 840	K811 38 - M	940	GS811 38	WS811 38	1 450
		812 38 - M			10 400	K812 38 - M	2 730	GS812 38	WS812 38	3 835
				894 38 - M	65 700	K894 38 - M	14 500	GS894 38	WS894 38	25 600
200	811 40 - M				4 000	K811 40 - M	980	GS811 40	WS811 40	1 510
		812 40 - M			11 910	K812 40 - M	3 090	GS812 40	WS812 40	4 410
				894 40 - M	74 800	K894 40 - M	16 200	GS894 40	WS894 40	29 300
220	811 44 - M				4 500	K811 44 - M	1 320	GS811 44	WS811 44	1 590
		812 44 - M			12 850	K812 44 - M	3 350	GS812 44	WS812 44	4 750
				894 44 - M	82 000	K894 44 - M	17 600	GS894 44	WS894 44	32 200
240	811 48 - M				7 250	K811 48 - M	2 110	GS811 48	WS811 48	2 570
		812 48 - M			21 950	K812 48 - M	5 650	GS812 48	WS812 48	8 150
				894 48 - M	87 800	K894 48 - M	19 200	GS894 48	WS894 48	34 300
260	811 52 - M				7 830	K811 52 - M	2 300	GS811 52	WS811 52	2 765
		812 52 - M			23 900	K812 52 - M	6 100	GS812 52	WS812 52	8 900
				894 52 - M	114 000	K894 52 - M	25 500	GS894 52	WS894 52	44 250
280	811 56 - M				10 300	K811 56 - M	3 000	GS811 56	WS811 56	3 650
		812 56 - M			25 900	K812 56 - M	6 400	GS812 56	WS812 56	9 750
				894 56 - M	142 000	K894 56 - M	30 800	GS894 56	WS894 56	55 600
300	811 60 - M				16 670	K811 60 - M	4 830	GS811 60	WS811 60	5 920
		812 60 - M			40 550	K812 60 - M	10 150	GS812 60	WS812 60	15 200
				894 60 - M	153 000	K894 60 - M	32 700	GS894 60	WS894 60	80 150
320	811 64 - M				17 820	K811 64 - M	5 120	GS811 64	WS811 64	6 350
				894 64 - M	42 600	K894 64 - M	10 700	GS894 64	WS894 64	15 950
340	811 68 [▲]				19 450	K811 68 [▲] - M	5 510	GS811 68 [▲]	WS811 68 [▲]	6 970
		812 68 [▲]			46 750	K812 68 [▲] - M	11 250	GS812 68 [▲]	WS812 68 [▲]	17 750
360	811 72 [▲]				19 500	K811 72 [▲] - M	5 550	GS811 72 [▲]	WS811 72 [▲]	6 975
		812 72 [▲]			65 650	K812 72 [▲] - M	17 250	GS812 72 [▲]	WS812 72 [▲]	24 200

▲ = Disponibile su richiesta / Available under request



Cuscinetti assiali a rulli cilindrici (serie 811 • 812 • 893 • 894)

Axial cylindrical roller bearings (811 • 812 • 893 • 894 series)

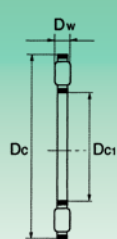

K811
K812

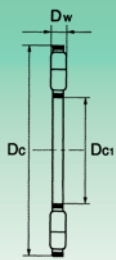

K893

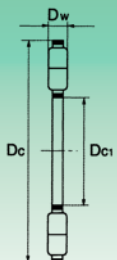

K894

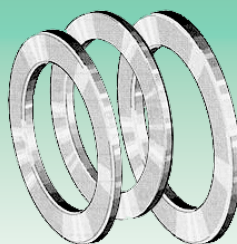

GS WS LS

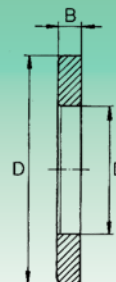

GS 811-812
893-894

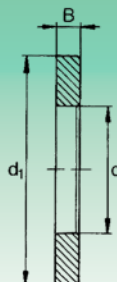

WS 811-812
893-894

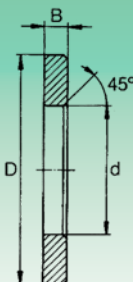

LS

Dimensioni (mm) Dimensions (mm)							Coefficienti di carico (N) Basic load ratings (N)		Velocità limite Limiting Speed
D _{c1} d	D ₁	D D _c	d ₁	T	D _w	B	Dinamico C Dynamic C	Statico C ₀ Static C ₀	Olio (N. giri max) Oil (max rpm)
180	183	225	222	34	14	10	339 600	1 299 700	1 300
180	183	250	247	56	22	17	689 780	2 439 500	1 200
180	184	360	360	109	36	36.5	2 200 400	8 199 300	1 000
190	193	240	237	37	15	11	384 700	1 498 900	1 200
190	194	270	267	62	26	18	879 300	2 998 900	1 200
190	195	380	380	115	38	38.5	2 449 400	9 198 300	950
200	203	250	247	37	15	11	394 650	1 549 300	1 200
200	204	280	277	62	26	18	899 700	3 149 150	1 100
200	205	400	400	122	40	41	2 699 100	10 198 500	900
220	223	270	267	37	15	11	419 780	1 729 635	1 100
220	224	300	297	63	26	18.5	939 960	3 449 750	1 000
220	225	420	420	122	40	41	2 899 100	11 499 890	850
240	243	300	297	45	18	13.5	599 850	2 498 800	1 000
240	244	340	335	78	32	23	1 369 600	4 999 100	950
240	245	440	440	122	40	41	2 995 900	12 189 900	800
260	263	320	317	45	18	13.5	619 400	2 649 700	950
260	264	360	355	79	32	23.5	1 439 500	5 398 900	900
260	265	480	480	132	44	44	3 548 860	14 599 850	750
280	283	350	347	53	22	15.5	859 000	3 649 750	850
280	284	380	375	80	32	24	1 450 000	5 595 000	800
280	285	520	520	145	48	48.5	4 190 600	17 399 000	650
300	304	380	376	62	25	18.5	1 050 000	4 495 000	800
300	304	420	415	95	38	28.5	1 920 000	7 298 500	750
300	305	540	540	145	48	48.5	4 298 950	18 300 000	650
320	324	400	396	63	25	19	1 050 500	4 7000 000	750
320	325	580	575	155	68	43.5	1 959 600	7 592 900	700
340	344	420	416	64	25	19.5	1 128 500	4 998 600	700
340	345	460	455	96	38	29	2 058 900	8 299 000	650
360	364	440	436	65	25	20	1 139 500	5 099 900	650
360	365	500	495	110	45	32.5	2 690 600	10 595 000	600



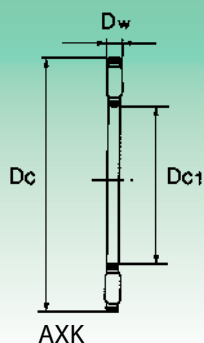

AXK



AS

Diametro albero (mm) Shaft diameter (mm)	Sigla Designation	Peso (g) Weight (g)	Ralla assiale Axial Bearing Washer	Peso (g) Weight (g)	Dimensioni (mm) Dimensions (mm)				Coefficienti di carico (N) Basic load ratings (N)		Velocità limite Limiting Speed
					Dc1/d	Dc/D	Dw	B ₁	Dinamico C Dynamic C	Statico C ₀ Static C ₀	Olio (N. giri max) Oil (max rpm)
4	AXK 0414 TN	0.7	AS 0414	1	4	14	2	1	4 380	7 500	20 000
5	AXK 0515 TN	0.8	AS 0515	1	5	15	2	1	4 680	9 100	20 000
6	AXK 0619 TN	1	AS 0619	2	6	19	2	1	6 740	15 400	18 000
8	AXK 0821 TN	2	AS 0821	2	8	21	2	1	7 750	19 000	17 000
10	AXK 1024	3	AS 1024	3	10	24	2	1	9 150	24 500	16 000
12	AXK 1226	3	AS 1226	3	12	26	2	1	9 860	28 600	14 250
15	AXK 1528	4	AS 1528	3	15	28	2	1	11 200	35 500	12 350
17	AXK 1730	4	AS 1730	4	17	30	2	1	11 800	38 600	11 400
20	AXK 2035	5	AS 2035	5	20	35	2	1	12 900	45 600	9 500
25	AXK 2542	7	AS 2542	7	25	42	2	1	13 800	57 800	8 000
30	AXK 3047	8	AS 3047	8	30	47	2	1	15 600	69 500	6 500
35	AXK 3552	10	AS 3552	9	35	52	2	1	16 900	80 100	6 100
40	AXK 4060	16	AS 4060	12	40	60	3	1	27 500	113 500	5 700
45	AXK 4565	18	AS 4565	13	45	65	3	1	29 050	127 600	4 750
50	AXK 5070	20	AS 5070	14	50	70	3	1	31 500	138 500	4 500
55	AXK 5578	28	AS 5578	18	55	78	3	1	37 400	185 000	4 100
60	AXK 6085	33	AS 6085	22	60	85	3	1	43 900	232 500	3 800
65	AXK 6590	35	AS 6590	24	65	90	3	1	45 800	254 600	3 500
70	AXK 7095	60	AS 7095	25	70	95	4	1	53 600	254 600	3 300
75	AXK 75100	61	AS 75100	27	75	100	4	1	54 500	264 500	3 100
80	AXK 80105	63	AS 80105	28	80	105	4	1	55 600	278 500	2 900
85	AXK 85110	67	AS 85110	29	85	110	4	1	57 500	275 000	2 850
90	AXK 90120	86	AS 90120	39	90	120	4	1	72 500	401 000	2 500
100	AXK 100135	104	AS 100135	50	100	135	4	1	90 500	559 500	2 400
110	AXK 110145	122	AS 110145	55	110	145	4	1	96 500	617 500	2 200
120	AXK 120155	131	AS 120155	59	120	155	4	1	101 500	679 000	2 000
130	AXK 130170	205	AS 130170	65	130	170	5	1	132 400	838 900	1 800
140	AXK 140180	219	AS 140180	79	140	180	5	1	137 200	899 000	1 700
150	AXK 150190	232	AS 150190	84	150	190	5	1	142 800	959 000	1 600
160	AXK 160200	246	AS 160200	89	160	200	5	1	147 600	1 015 000	1 500

TN= Gabbia in materiale plastico, temperatura di funzionamento ammessa: 80°C (continuativi).

TN= Plastic cage; temperature allowed: 80°C. (continuous working).

Lubrificazione con grasso: 25% in meno dei valori indicati in tabella.

Grease lubrication: less 25% of value indicated in tables.



Cuscinetti assiali a rullini con bordo di centraggio nella ralla assiale (serie AXW)

Axial needle roller bearings with centring spigot on the bearing washer (AXW series)

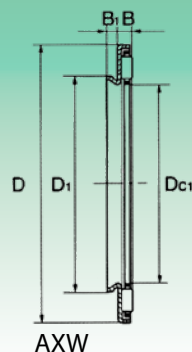

Diametro albero (mm) Shaft diameter (mm)	Sigla Designation	Peso (g) Weight (g)	Dimensioni (mm) Dimensions (mm)					Coefficienti di carico (N) Basic load ratings (N)		Velocità limite Limiting Speed Olio (N. giri max) Oil (max rpm)
			Dc ₁	D ₁	D	B	B ₁	Dinamico C Dynamic C	Statico C ₀ Static C ₀	
10	AXW 10	8.3	10	14	27	3.2	3	9 100	24 000	15 200
12	AXW 12	9.1	12	16	29	3.2	3	9 400	27 800	13 300
15	AXW 15	10.1	15	21	31	3.2	3.5	10 500	35 000	12 350
17	AXW 17	11	17	23	33	3.2	3.5	11 300	38 800	11 400
20	AXW 20	14	20	26	38	3.2	3.5	12 700	45 600	10 000
25	AXW 25	19.5	25	32	45	3.2	4	13 900	57 500	7 600
30	AXW 30	22	30	37	50	3.2	4	15 900	69 500	6 650
35	AXW 35	26.6	35	42	55	3.2	4	17 000	80 100	6 200
40	AXW 40	39.2	40	47	63	4.2	4	27 800	109 000	5 200
45	AXW 45	43.4	45	52	68	4.2	4	29 500	121 600	4 750
50	AXW 50	49.2	50	58	73	4.2	4.5	31 800	140 900	4 500

Lubrificazione con grasso: 25% in meno dei valori indicati in tabella.

Grease lubrication: less 25% of value indicated in tables.



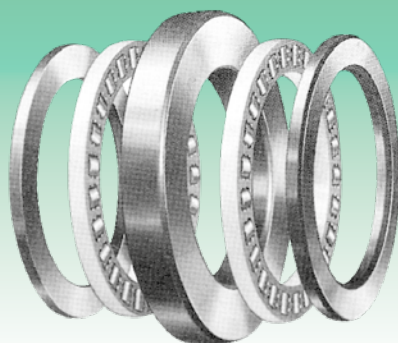

ZSI

Diametro albero (mm) <i>Shaft Diameter (mm)</i>	Sigla <i>Designation</i>	Peso (g) <i>Weight (g)</i>	Dimensioni (mm) <i>Dimensions (mm)</i>			Gabbie assiali a rullini <i>Axial needle roller</i>	Gabbie assiali a rulli cilindrici <i>Axial cylindrical roller</i>	Ralle per alloggiamento <i>Housing locating Washers</i>
			d	D	B			
15	ZSI 1127	21	11	27	5.5	AXK 1528	K 811 02 TN	GS 811 02
17	ZSI 1329	23	13	29	5.5	AXK 1730	K 811 03 TN	GS 811 03
20	ZSI 1634	31	16	34	5.5	AXK 2035	K 811 04 TN	GS 811 04
25	ZSI 2141	45	21	41	6	AXK 2542	K 811 05 TN	GS 811 05
30	ZSI 2646	60	26	46	7	AXK 3047	K 811 06 TN	GS 811 06
35	ZSI 3151	78	31	51	8	AXK 3552	K 811 07 TN	GS 811 07
40	ZSI 3159	125	31	59	8	AXK 4060	K 811 08 TN	GS 811 08
45	ZSI 3664	156	36	64	9	AXK 4565	K 811 09 TN	GS 811 09
50	ZSI 4169	191	41	69	10	AXK 5070	K 811 10 TN	GS 811 10
55	ZSI 4677	235	46	77	10	AXK 5578	K 811 11 TN	GS 811 11
60	ZSI 5184	316	51	84	11.5	AXK 6085	K 811 12 TN	GS 811 12
65	ZSI 5689	360	56	89	12	AXK 6590	K 811 13 TN	GS 811 13
70	ZSI 5694	440	56	94	12.5	AXK 7095	K 811 14 TN	GS 811 14
75	ZSI 6199	470	61	99	12.5	AXK 75100	K 811 15 TN	GS 811 15
80	ZSI 66104	500	66	104	12.5	AXK 80105	K 811 16 TN	GS 811 16
85	ZSI 71109	593	71	109	14.5	AXK 85110	K 811 17 TN	GS 811 17
90	ZSI 76119	806	76	119	16	AXK 90120	K 811 18 TN	GS 811 18
100	ZSI 86134	1 180	86	134	18	AXK 100135	K 811 20 TN	GS 811 20
110	ZSI 96144	1 430	96	144	20	AXK 110145	K 811 22 TN	GS 811 22
120	ZSI 101154	1 830	101	154	22	AXK 120155	K 811 24	GS 811 24
130	ZSI 111169	2 210	111	169	22	AXK 130170	K 811 26	GS 811 26
140	ZSI 121179	2 460	121	179	23	AXK 140180	K 811 28	GS 811 28
150	ZSI 131189	2 740	131	189	24	AXK 150190	K 811 30	GS 811 30
160	ZSI 141199	3 030	141	199	25	AXK 160200	K 811 32	GS 811 32

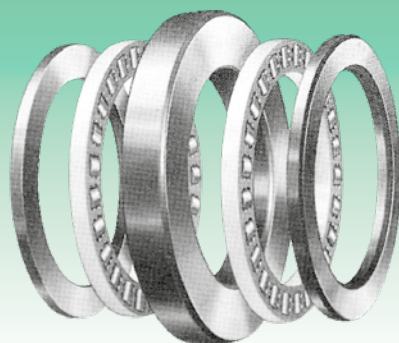
Ralle intermedie con centraggio esterno (serie ZSE)
Intermediate washers with outer centering (ZSE series)

ZSE

Diametro albero (mm) Shaft Diameter (mm)	Ralle intermedie Designation of Center Washers	Peso (g) Weight (g)	Dimensioni (mm) Dimensions (mm)			Gabbie assiali a rullini Axial needle roller	Gabbie assiali a rulli cilindrici Axial cylindrical roller	Ralle per albero Shaft locating washers
			d	D	B			
15	ZSE 1634	31	16	34	5,5	AXK 1528	K 811 02 TN	WS 811 02
20	ZSE 2141	45	21	41	6	AXK 2035	K 811 04 TN	WS 811 04
25	ZSE 2646	60	26	46	7	AXK 2542	K 811 05 TN	WS 811 05
30	ZSE 3151	78	31	51	8	AXK 3047	K 811 06 TN	WS 811 06
35	ZSE 3664	156	36	64	9	AXK 3552	K 811 07 TN	WS 811 07
40	ZSE 4169	191	41	69	10	AXK 4060	K 811 08 TN	WS 811 08
45	ZSE 4677	235	46	77	10	AXK 4565	K 811 09 TN	WS 811 09
50	ZSE 5184	316	51	84	11,5	AXK 5070	K 811 10 TN	WS 811 10
55	ZSE 5689	360	56	89	12	AXK 5578	K 811 11 TN	WS 811 11
60	ZSE 6199	470	61	99	12,5	AXK 6085	K 811 12 TN	WS 811 12
65	ZSE 66104	500	66	104	12,5	AXK 6590	K 811 13 TN	WS 811 13
70	ZSE 71109	593	71	109	14,5	AXK 7095	K 811 14 TN	WS 811 14
75	ZSE 76119	806	76	119	16	AXK 75100	K 811 15 TN	WS 811 15
85	ZSE 86134	1 180	86	134	18	AXK 85110	K 811 17 TN	WS 811 17
100	ZSE 101154	1 830	101	154	22	AXK 100135	K 811 20 TN	WS 811 20
110	ZSE 111169	2 210	111	169	22	AXK 110145	K 811 22 TN	WS 811 22
120	ZSE 121179	2 460	121	179	23	AXK 120155	K 811 24	WS 811 24
130	ZSE 131189	2 740	131	189	24	AXK 130170	K 811 26	WS 811 26
140	ZSE 141199	3 030	141	199	25	AXK 140180	K 811 28	WS 811 28
150	ZSE 151214	3 830	151	214	27	AXK 150190	K 811 30	WS 811 30
160	ZSE 161224	4 350	161	224	29	AXK 160200	K 811 32	WS 811 32





ROTELLE A RULLI

YOKE TYPE TRACK ROLLERS

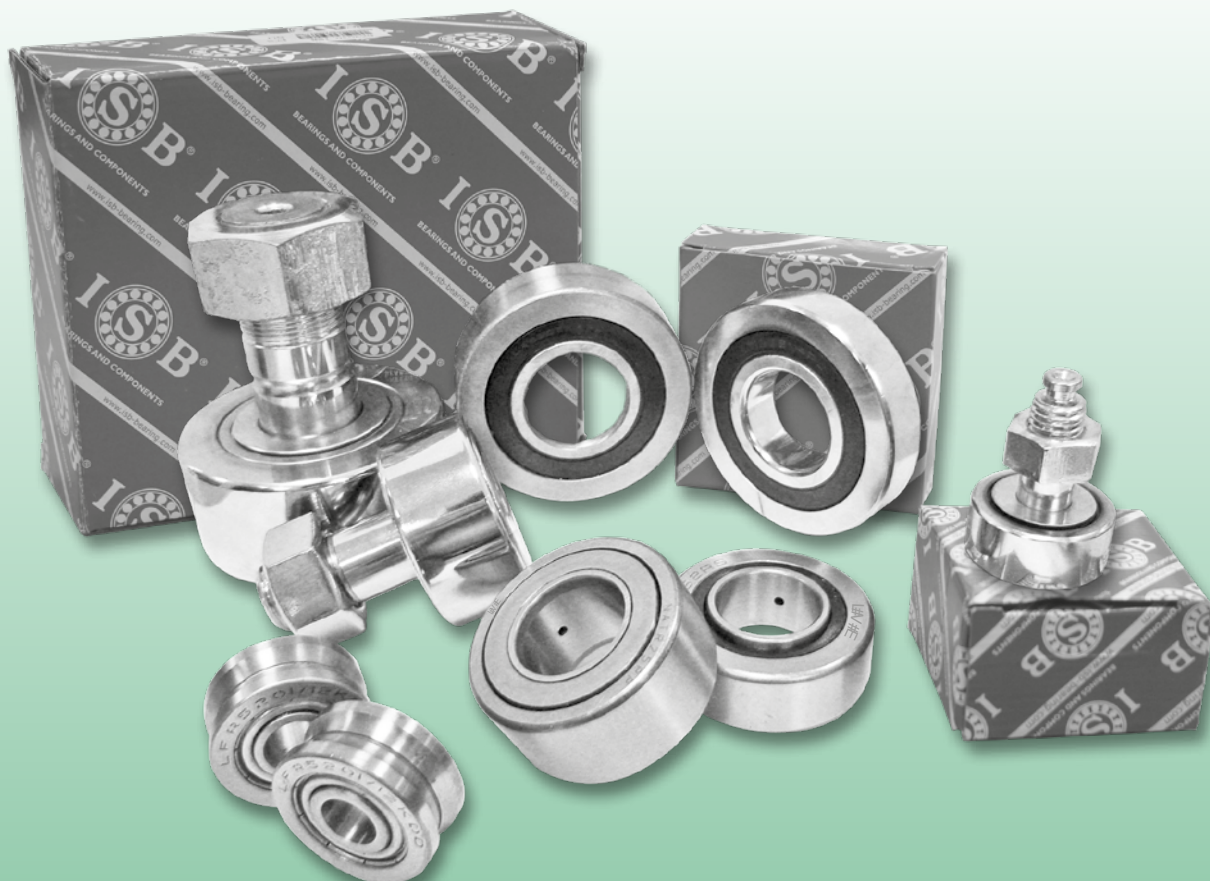



Rotelle a rulli

Yoke type track rollers

Le rotelle a rulli hanno come caratteristica principale quella di avere un anello esterno con uno spessore molto alto, permettendo così l'assorbimento di carichi radiali elevati. Le rotelle a rulli hanno la superficie esterna bombata, questo consente di ridurre il carico sugli spigoli. Se le rotelle a rulli vengono utilizzate operando su delle piste di rotolamento piane occorre utilizzare i coefficienti di carico Cw e Co. Le rotelle a rulli trovano utilizzo in particolar modo come rotelle di pressione e rotelle per bilancieri o semplici guide lineari.

Tipologia RSTO e STO

Le rotelle a rulli appartenenti a queste due tipologie hanno la possibilità di montare gli anelli interni ed esterni e la gabbia in modo separato, in quanto non costituiscono un unico corpo volvente, sono adatti al raggiungimento di alte velocità di rotazione quindi soggetti ad una lubrificazione con olio. Si ricorda sempre di controllare che la tipologia del lubrificante usato all'origine e quello che si andrà ad utilizzare sia compatibile. L'anello esterno e la gabbia a rullini devono essere guidati in modo assiale.

Tipologia RNA 22..-2RS e NA..-2RS

Le rotelle a rulli che appartengono alle categorie sopraindicate sono forniti completi di anelli di tenuta ad entrambi i lati. L'anello esterno, la gabbia a rullini e gli anelli di tenuta formano un unico corpo volvente. Le rotelle a rulli con anelli di tenuta presentano il vantaggio di una manutenzione molto ridotta e un buon grado di trattenimento del grasso, anche se occorre ricordare di non eccedere oltre le temperature ammissibili cioè -30° C. +80° C.

Tipologia NATR e NATR..PP

Le rotelle a rulli della serie NATR sono costituite da una gabbia a rullini, da un anello esterno e uno interno. Presentano come caratteristica principale quella di sopportare carichi molto elevati e possono essere impiegati in molteplici applicazioni. Si ricorda che grazie allo spazio disponibile, questi prodotti possono contenere una elevata quantità di grasso, quindi se ne deduce che la lubrificazione avrà degli intervalli piuttosto lunghi. Le rotelle a rulli munite di anelli di tenuta appartenenti alla serie NATR..PP dovranno essere utilizzate sempre rispettando le temperature massime accettabili -30° C. +80° C.

Tipologia NATV e NATV..PP

Le rotelle a rulli appartenenti alla serie sopraindicata hanno la caratteristica principale di essere a pieno riempimento di rullini, l'anello esterno e quello interno sono i medesimi della serie NATR.

Inoltre le rotelle a rulli NATV hanno una capacità di carico maggiore rispetto alle rotelle a rulli NATR.

Si consiglia una lubrificazione frequente e si ricorda che per le rotelle a rulli fornite con anelli di tenuta vale il discorso fatto per le NATR, cioè di non oltrepassare le temperature massime sopportabili.

Yoke type track rollers have an outer ring with a very high thickness, which enables them to stand heavy radial loads.

Yoke type track rollers thanks to their outer barrel surface, can reduce load on the edges; when they are utilised on flat guideways, Cw and Co load rating must be used.

ISB yoke type track rollers, are utilised as pressure rollers, as simple linear guideways or as roller for equalizers.

RSTO and STO type

RSTO and STO, are able to mount outer rings, inner rings and cage in a separate way and seen that they are not a sole group, they can reach very high rotation speeds and for this reason have to be oil lubricated.

The original lubricant must be compatible with the future one. Outer ring and needle roller cage have to be axially guided.

RNA22..-2RS and NA..-2RS type

These yoke track rollers are sealed on both ends ; outer ring, needle roller cage and seals create a sole group.

The seals give the opportunity to reduce the upkeep and to increase grease restraint: contact seals are thermally stable in a temperature range between -30°C and +80°C.

NATR and NATR .. PP type

NATR and NATR..PP, are formed by a needle roller cage, by an outer and an inner ring; they can stand very heavy loads and can be used in many different applications.

Thanks to the space available these products can contain big quantity of grease, therefore relubrication requires rather long interval.

NATR..PP sealed type, are thermally stable in a temperature range between -30°C and +80°C.

NATV and NATV..PP type

The above yoke type track rollers have a full-complement design , outer and inner ring are the same as NATR ones.

NATV have higher load ability respect to NATR.

We recommend to relubricate them often and to not exceed temperatures suggested for NATR.

**Tipologia NUTR / PWTR..2RS / NNTR..ZZ**

Le rotelle a rulli NUTR come le NATV sono a pieno riempimento di rulli, l'anello esterno è dotato di un doppio bordo, che permette di guidarle assialmente. Queste rotelle a rulli possono sopportare elevati carichi radiali e anche sforzi laterali grazie alla guida assiale. Le rotelle a rulli che sono fornite di anello esterno con uno spessore elevato possono sopportare carichi altissimi, occorre ricordarsi che questo tipo di rotelle a rulli è soggetto a una lubrificazione molto frequente. Le rotelle a rulli sono solitamente fornite con classe di tolleranza PO e un giuoco radiale di classe C2, ma dietro richiesta espressa della clientela possono essere fornite con classe di tolleranza P5 e P6.

Le rotelle a rulli della serie PWTR..2RS sono dotate di un nuovo profilo ottimizzato della superficie esterna. Nelle rotelle di questo tipo si ha: minor pressione di contatto; minor carico sugli spigoli in caso di ribaltamento; minor usura della contropista e pertanto maggior durata. Le rotelle PWTR..2RS munite di tenute dovranno essere utilizzate sempre rispettando le temperature massime accettabili da -30 °C a +120 °C.

Le rotelle a rulli della serie NNTR..ZZ sono a pieno riempimento di rulli, questo consente un'elevata capacità di carico. La guida assiale dell'anello esterno avviene tramite corpi volventi e bordo. Le rotelle NNTR..ZZ hanno lo schermo di protezione provvisto di anelli lamellari su entrambi i lati.

NUTR / PWTR..2RS / NNTR..ZZ type

NUTR, as NATV have a full-complement design, outer ring has two edges which enable it to driven them axially.

These yoke track rollers, are particularly suitable for heavy loads and able to stand lateral efforts thanks to their axial guidance.

Very high loads can be stood from yoke track rollers supplied with an high thickness outer ring: these have to be relubricated often. PWTR..2RS series have a new optimized profile for the outer surface. This type of yoke track rollers present: lower pressure, lower edge loading if tilting occurs, lower wear of the mating track and extended operating life of the mating track.

PWTR..2RS are thermally stable in a temperature range between -30 °C to +120 °C.

NNTR..ZZ yoke track rollers series have a full complement cylindrical roller set, this allows high load capacity. The axial guidance of the outer ring is made by rolling elements and rib. NNTR..ZZ yoke track rollers series have sealing shield with lamellar rings

Tipologie delle rotelle a rulli

Yoke type track rollers

Tipo-Type	Caratteristiche-Characteristics
RSTO	Senza guida assiale, anello esterno senza bordo e senza anello interno <i>Without axial guide, outer ring, edge and inner ring</i>
STO	Senza guida assiale, anello esterno senza bordo con anello interno <i>Without axial guide, outer ring edge and with inner ring</i>
RNA 22..2RS	Senza guida assiale, con anelli di tenuta ad entrambi i lati, senza anello interno <i>Without axial guide, with seals on both sides and no inner ring</i>
NA 22..2RS	Senza guida assiale, con anelli di tenuta ad entrambi i lati, con anello interno <i>Without axial guide, with seals on both sides and inner ring</i>
NATR	Con guida assiale, con tenuta non strisciante, con anello interno <i>With axial guide, non slippery seal and inner ring</i>
NATR..PP	Con anelli di tenuta supplementari <i>With additional seals</i>
NATV	Con guida assiale, a pieno riempimento di rullini, con tenuta non strisciante e con anello interno <i>With axial guide, full complements needle rollers, with non slippery seal and inner ring</i>
NATV..PP	Con anelli di tenuta supplementari <i>With additional seals</i>
NUTR	Con guida assiale, a pieno riempimento di rulli, con tenuta a labirinto e con anello interno <i>With axial guide, full complement rollers, labyrinth seal and inner ring</i>
PWTR..2RS	Con guida assiale dell'anello esterno tramite corpi volventi e bordo, a pieno riempimento di rulli, con tenute a labbro ai due lati e anello interno <i>With axial guidance for the outer ring by the rolling elements and rib, full complement cylindrical roller set, with lip seals on both sides and inner ring</i>
NNTR..ZZ	Con guida assiale dell'anello esterno tramite corpi volventi e bordo, a pieno riempimento di rulli, schermo di protezione con anelli lamellari su entrambi i lati <i>With axial guidance for the outer ring by the rolling elements and rib, full complement cylindrical roller set, sealing shield with lamellar rings</i>



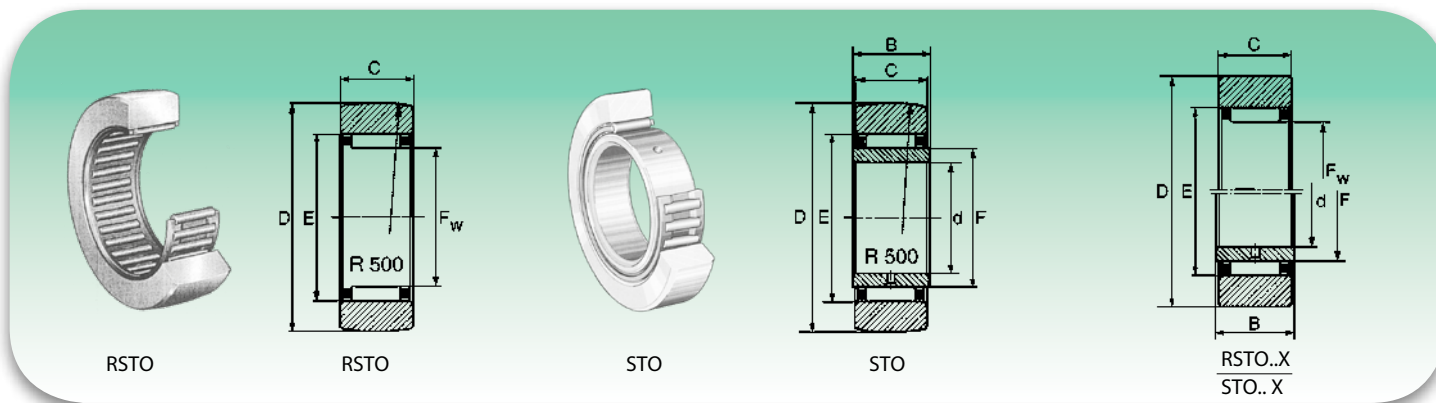

Diametro esterno (mm) Outside Diameter (mm)	Sigla ¹⁾ Designation				Dimensioni (mm) Dimensions (mm)						Coefficienti di carico N ²⁾ Basic Load Rating N				Velocità limite Limiting Speed	
	Senza anello interno Without IR	Peso (g) Weight (g)	Con anello interno With IR	Peso (g) Weight (g)	D	d	F _w F _w	B	C	d ₁	Dinamico C _d Dynamic C _d	Statico C _s Static C _s	Come rullo di appoggio Yoke type track roller			Grasso ³⁾ Grease (N° giri max) (max rpm)
													Din. C _{sw} Dyn. C _{sw}	Stat. C _{sw} Stat. C _{sw}		
16	RSTO 5 TN	8.5	-	-	16	-	7	-	7.8	10	2 800	2 600	2 550	2 550	23 000	
	RSTO 5 TN X	8.5	-	-	16	-	7	-	7.8	10	2 800	2 600	2 550	2 550	23 000	
19	RSTO 6 TN	12.5	STO 6 TN	17	19	6	10	10	9.8	13	4 700	5 450	3 750	4 500	20 000	
	RSTO 6 TN X	12.5	STO 6 TN X	17	19	6	10	10	9.8	13	4 700	5 450	3 750	4 500	20 000	
24	RSTO 8 TN	21	STO 8 TN	26	24	8	12	10	9.8	15	4 800	6 000	4 000	5 225	16 000	
	RSTO 8 TN X	21	STO 8 TN X	26	24	8	12	10	9.8	15	4 800	6 000	4 000	5 225	16 000	
30	RSTO 10	42	STO 10	49	30	10	14	12	11.8	20	10 200	10 500	8 400	9 200	11 000	
	RSTO 10 X	42	STO 10 X	49	30	10	14	12	11.8	20	10 200	10 500	8 400	9 200	11 000	
32	RSTO 12	49	STO 12	57	32	12	16	12	11.8	22	11 300	12 300	8 900	10 100	9 000	
	RSTO 12 X	49	STO 12 X	57	32	12	16	12	11.8	22	11 300	12 300	8 900	10 100	9 000	
35	RSTO 15	50	STO 15	63	35	15	20	12	11.8	26	13 200	16 000	9 100	10 700	6 500	
	RSTO 15 X	50	STO 15 X	63	35	15	20	12	11.8	26	13 200	16 000	9 100	10 700	6 500	
40	RSTO 17	88	STO 17	107	40	17	22	16	15.8	29	19 800	25 300	14 300	17 700	5 500	
	RSTO 17 X	88	STO 17 X	107	40	17	22	16	15.8	29	19 800	25 300	14 300	17 700	5 500	
47	RSTO 20	130	STO 20	152	47	20	25	16	15.8	32	20 800	27 800	16 200	21 500	4 700	
	RSTO 20X	130	STO 20 X	152	47	20	25	16	15.8	32	20 800	27 800	16 200	21 500	4 700	
52	RSTO 25	150	STO 25	177	52	25	30	16	15.8	37	23 000	33 400	16 500	22 900	3 600	
	RSTO 25 X	150	STO 25 X	177	52	25	30	16	15.8	37	23 000	33 400	16 500	22 900	3 600	
62	RSTO 30	255	STO 30	308	62	30	38	20	19.8	46	35 200	56 700	23 300	35 000	2 500	
	RSTO 30 X	255	STO 30 X	308	62	30	38	20	19.8	46	35 200	56 700	23 300	35 000	2 500	
72	RSTO 35	375	STO 35	441	72	35	42	20	19.8	50	35 800	58 800	26 000	41 000	2 200	
	RSTO 35 X	375	STO 35 X	441	72	35	42	20	19.8	50	35 800	58 800	26 000	41 000	2 200	
80	RSTO 40	420	STO 40	530	80	40	50	20	19.8	58	35 200	61 800	24 000	39 000	1 700	
	RSTO 40 X	420	STO 40 X	530	80	40	50	20	19.8	58	35 200	61 800	24 000	39 000	1 700	
85	RSTO 45	453	STO 45	576	85	45	55	20	19.8	63	38 900	73 900	25 500	43 000	1 500	
	RSTO 45 X	453	STO 45 X	576	85	45	55	20	19.8	63	38 900	73 900	25 500	43 000	1 500	
90	RSTO 50	481	STO 50	617	90	50	60	20	19.8	68	43 300	84 800	26 000	46 500	1 300	
	RSTO 50 X	481	STO 50 X	617	90	50	60	20	19.8	68	43 300	84 800	26 000	46 500	1 300	

1) F= Diametro pista di rotolamento dell'anello interno.

F= Diameter of rolling groove on inner ring.

F_w= Tolleranza diametro del cerchio dato dai rullini.

F_w= Diameter tolerance of circle given by needle rollers.

2) C e C_s coefficienti di carico: per utilizzo con accoppiamento come cuscinetti volventi.

C and C_s load ratings: coupling as bearings.

C_{sw} e C_{sw} coefficienti di carico: per utilizzo come rullo d'appoggio.

C_{sw} and C_{sw} load ratings: used as roller support.

3) Con lubrificazione ad olio il limite dei giri aumenta del 25% circa.

With oil lubrication, number of allowed revolutions increases of about 25%.

4) Suffisso x: anello esterno cilindrico

X suffix: outer cylindrical ring

Rotelle a rulli senza guida assiale con tenute (serie RNA22..2RS • RNA22..2RSX - NA22..2RS • NA22..2RSX)



Sealed yoke type track rollers without axial guidance (RNA22..2RS • RNA22..2RSX - NA22..2RS • NA22..2RSX series)



RNA 22..2RS

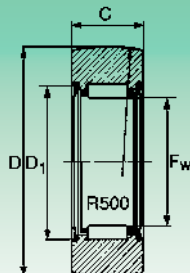

RNA 22..2RS



NA 22..2RS

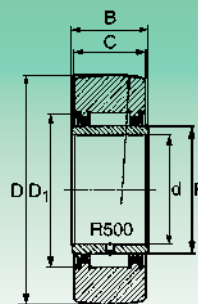

NA 22..2RS

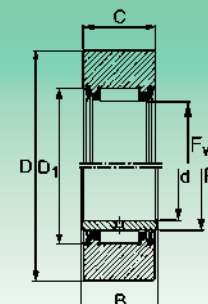
 RNA 22..2RS X
NA 22..2RS X

Diametro esterno (mm) Outside Diameter (mm)	Sigla ¹⁾ Designation				Dimensioni (mm) Dimensions (mm)						Coefficienti di carico N ²⁾ Basic Load Rating N				Velocità limite Limiting Speed (N° giri max) (max rpm)	
	Senza anello interno Without IR	Peso (g) Weight (g)	Con anello interno With IR	Peso (g) Weight (g)	D	d	F ₁ F _w	B	C	d ₁	Dinamico C _d Dynamic C _d	Statico C _s Static C _s	Come rullo di appoggio Yoke type track roller			Grasso ³⁾ Grease (N° giri max) (max rpm)
													Din. C _w Dyn. C _w	Stat. C _{ow} Stat. C _{ow}		
19	RNA 22/6 2RS	18	NA 22/6 2RS	22	19	6	10	12	11.8	16	5 050	4 400	3 700	3 500	18 000	
	RNA 22/6 2RS X	18	NA 22/6 2RS X	22	19	6	10	12	11.8	16	5 050	4 400	3 700	3 500	18 000	
24	RNA 22/8 2RS	29	NA 22/8 2RS	34	24	8	12	12	11.8	18	5 400	5 200	4 600	4 600	14 000	
	RNA 22/8 2RS X	29	NA 22/8 2RS X	34	24	8	12	12	11.8	18	5 400	5 200	4 600	4 600	14 000	
30	RNA 2200 2RS	52	NA 2200 2RS	60	30	10	14	14	13.8	20	7 400	7 900	6 700	7 600	11 000	
	RNA 2200 2RS X	52	NA 2200 2RS X	60	30	10	14	14	13.8	20	7 400	7 900	6 700	7 600	11 000	
32	RNA 2201 2RS	57	NA 2201 2RS	67	32	12	16	14	13.8	22	8 300	9 400	7 200	8 600	9 500	
	RNA 2201 2RS X	57	NA 2201 2RS X	67	32	12	16	14	13.8	22	8 300	9 400	7 200	8 600	9 500	
35	RNA 2202 2RS	60	NA 2202 2RS	75	35	15	20	14	13.8	26	9 300	11 700	7 300	9 100	7 000	
	RNA 2202 2RS X	60	NA 2202 2RS X	75	35	15	20	14	13.8	26	9 300	11 700	7 300	9 100	7 000	
40	RNA 2203 2RS	94	NA 2203 2RS	112	40	17	22	16	15.8	28	11 600	15 900	9 400	13 100	6 000	
	RNA 2203 2RS X	94	NA 2203 2RS X	112	40	17	22	16	15.8	28	11 600	15 900	9 400	13 100	6 000	
47	RNA 2204 2RS	152	NA 2204 2RS	177	47	20	25	18	17.8	33	18 000	21 200	14 450	17 400	4 600	
	RNA 2204 2RS X	152	NA 2204 2RS X	177	47	20	25	18	17.8	33	18 000	21 200	14 450	17 400	4 600	
52	RNA 2205 2RS	179	NA 2205 2RS	209	52	25	30	18	17.8	38	20 000	25 650	14 900	19 000	3 500	
	RNA 2205 2RS X	179	NA 2205 2RS X	209	52	25	30	18	17.8	38	20 000	25 650	14 900	19 000	3 500	
62	RNA 2206 2RS	284	NA 2206 2RS	324	62	30	35	20	19.8	43	22 200	30 400	17 400	24 300	2 800	
	RNA 2206 2RS X	284	NA 2206 2RS X	324	62	30	35	20	19.8	43	22 200	30 400	17 400	24 300	2 800	
72	RNA 2207 2RS	432	NA 2207 2RS	505	72	35	42	23	22.7	50	28 500	44 200	22 000	33 700	2 200	
	RNA 2207 2RS X	432	NA 2207 2RS X	505	72	35	42	23	22.7	50	28 500	44 200	22 000	33 700	2 200	
80	RNA 2208 2RS	530	NA 2208 2RS	628	80	40	48	23	22.7	57	36 600	55 100	26 200	38 500	1 700	
	RNA 2208 2RS X	530	NA 2208 2RS X	628	80	40	48	23	22.7	57	36 600	55 100	26 200	38 500	1 700	
85	RNA 2209 2RS	545	NA 2209 2RS	655	85	45	52	23	22.7	62	38 500	60 800	27 100	40 850	1 600	
	RNA 2209 2RS X	545	NA 2209 2RS X	655	85	45	52	23	22.7	62	38 500	60 800	27 100	40 850	1 600	
90	RNA 2210 2RS	563	NA 2210 2RS	690	90	50	58	23	22.7	68	40 400	66 500	26 600	40 400	1 300	
	RNA 2210 2RS X	563	NA 2210 2RS X	690	90	50	58	23	22.7	68	40 400	66 500	26 600	40 400	1 300	

- 1) F = Diametro pista di rotolamento dell'anello interno.
F = Diameter of rolling groove on inner ring.
F_w = Tolleranza diametro del cerchio dato dai rullini.
F_w = Diameter tolerance of circle given by needle rollers.
- 2) C e C_o coefficienti di carico: per utilizzo con accoppiamento come cuscinetti volenti.
C and C_o load ratings: coupling as bearings.
C_w e C_{ow} coefficienti di carico: per utilizzo come rullo d'appoggio.
C_w and C_{ow} load ratings: used as roller support.
- 3) Con lubrificazione ad olio il limite dei giri aumenta del 25% circa.
With oil lubrication, number of allowed revolutions increases of about 25%.
- 4) Suffisso x: anello esterno cilindrico
X suffix: outer cylindrical ring

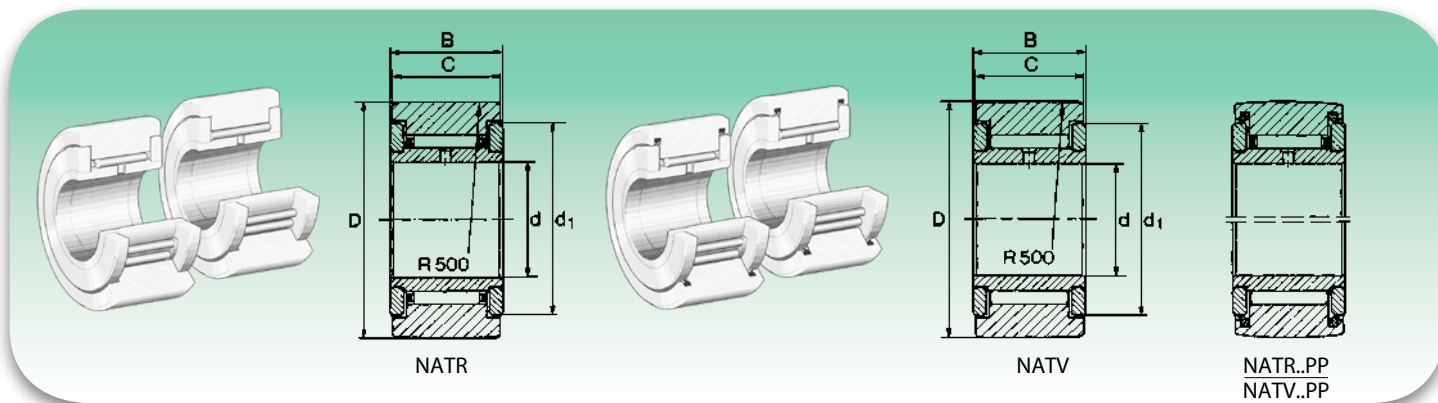

Diametro esterno (mm) Outside Diameter (mm)	Sigla ¹⁾ Designation				Dimensioni (mm) Dimensions (mm)					Coefficienti di carico N ²⁾ Basic Load Rating N				Velocità limite Limiting Speed Grasso ³⁾ Grease (N° giri max) (max rpm)
	Con anello interno With IR	Peso (g) Weight (g)	Con anello interno e tenute supplementari With IR and additional seals	Peso (g) Weight (g)	d	D	B	C	d ₁	Dinamico C _d Dynamic C	Statico C _s Static C _s	Come rullo di appoggio Yoke type track roller		
												Din. C _{ow} Dyn. C _{ow}	Stat. C _{ow} Stat. C _{ow}	
16	NATR 5	14	NATR 5 PP	14	5	16	12	11	12.5	3 600	3 560	3 000	3 100	1 350 ⁴⁾
	NATV 5	15	NATV 5 PP	15	5	16	12	11	12.5	6 100	8 100	4 600	6 200	8 100
19	NATR 6	20	NATR 6 PP	19	6	19	12	11	15	4 050	4 370	3 300	3 700	19 000 ⁴⁾
	NATV 6	21	NATV 6 PP	21	6	19	12	11	15	6 950	10 250	5 200	7 500	6 600
24	NATR 8	41	NATR 8 PP	38	8	24	15	14	19	6 450	7 300	5 200	6 080	14 500 ⁴⁾
	NATV 8	42	NATV 8 PP	41	8	24	15	14	19	9 900	14 800	7 400	10 800	5 300
30	NATR 10	64	NATR 10 PP	61	10	30	15	14	23	7 700	9 200	6 500	8 000	10 500 ⁴⁾
	NATV 10	65	NATV 10 PP	64	10	30	15	14	23	11 600	18 000	9 000	13 850	4 300
32	NATR 12	71	NATR 12 PP	66	12	32	15	14	25	8 300	10 450	6 550	8 350	8 600
	NATV 12	72	NATV 12 PP	69	12	32	15	14	25	12 540	20 600	9 200	14 600	3 700
35	NATR 15	104	NATR 15 PP	95	15	35	19	18	27.6	12 250	18 000	9 200	13 400	6 600
	NATV 15	109	NATV 15 PP	101	15	35	19	18	27.6	17 400	33 250	12 150	21 850	3 200
40	NATR 17	144	NATR 17 PP	139	17	40	21	20	31.5	13 500	19 400	10 350	14 700	5 700
	NATV 17	152	NATV 17 PP	147	17	40	21	20	31.5	19 950	37 500	14 050	25 200	2 700
47	NATR 20	246	NATR 20 PP	236	20	47	25	24	36.5	18 500	30 400	14 700	24 200	4 700
	NATV 20	254	NATV 20 PP	245	20	47	25	24	36.5	26 600	56 050	19 550	39 900	2 500
52	NATR 25	275	NATR 25 PP	271	25	52	25	24	41.5	20 150	36 100	14 600	25 200	3 400
	NATV 25	285	NATV 25 PP	281	25	52	25	24	41.5	29 450	68 400	19 500	41 800	2 000
62	NATR 30	470	NATR 30 PP	444	30	62	29	28	51	32 300	56 000	22 450	36 600	2 500
	NATV 30	481	NATV 30 PP	468	30	62	29	28	51	46 100	102 600	29 000	59 850	1 600
72	NATR 35	635	NATR 35 PP	547	35	72	29	28	58	35 150	65 550	24 200	42 300	1 900
	NATV 35	647	NATV 35 PP	630	35	72	29	28	58	50 350	120 650	31 350	69 350	1 300
80	NATR 40	805	NATR 40 PP	795	40	80	32	30	66	46 550	89 300	31 350	56 000	1 600
	NATV 40	890	NATV 40 PP	832	40	80	32	30	66	62 700	151 050	38 950	85 500	1 200
90	NATR 50	960	NATR 50 PP	867	50	90	32	30	76	49 400	102 600	30 400	56 050	1 200
	NATV 50	990	NATV 50 PP	969	50	90	32	30	76	68 400	181 450	38 500	88 350	950

- Suffisso x: anello esterno cilindrico
X suffix: outer cylindrical ring
- C e C_s coefficienti di carico: per utilizzo con accoppiamento come cuscinetti volventi.
C and C_s load ratings: coupling as bearings.
C_{ow} e C_{ow} coefficienti di carico: per utilizzo come rullo d'appoggio.
C_{ow} and C_{ow} load ratings: used as roller support.
- Con lubrificazione ad olio il limite dei giri aumenta del 25% circa.
With oil lubrication, number of allowed revolutions increases of about 25%.
- Per esecuzione con tenute ridurre il valore del 30%
Value must be reduced of 30% in case of execution with seals



Rotelle a rulli con guida assiale, a pieno riempimento di rulli , schermati (serie NNTR)

Yoke type track rollers with axial guidance, full complement cylindrical roller set, sealed on both sides (NNTR series)

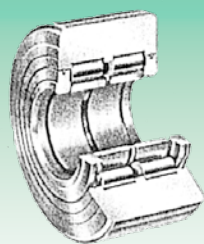

NNTR.ZZ

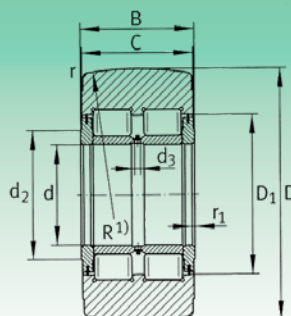

Diametro esterno (mm) <i>Outside Diameter (mm)</i>	Sigla <i>Designation</i>	Peso (g) <i>Weight (g)</i>	Dimensioni (mm) <i>Dimensions (mm)</i>				Dimensioni delle parti adiacenti <i>Mounting dimensions</i>			Fori di lubrificazione <i>Lubrication holes</i>	Coefficienti di carico N Basic <i>Load Rating N</i>		Velocità limite <i>Limiting speed</i> (N° di giri max) <i>(max rpm)</i>
			d	D	B	C	d ₂	D ₁	d ₃		Dinamico C _w <i>Dynamic C_w</i>	Statico C _{ow} <i>Static C_{ow}</i>	
130	NNTR 50X130X65 ZZ	5 200	50	130	65	63	63	80	3	3	192 000	250 000	1 100
140	NNTR 55X140X70 ZZ	6 400	55	140	70	68	73	91	4	3	223 000	300 000	850
150	NNTR 60X150X75 ZZ	7 800	60	150	75	73	78	97	4	3	255 000	350 000	800
160	NNTR 65X160X75 ZZ	8 800	65	160	75	73	82	103	5	3	275 000	370 000	700
180	NNTR 70X180X85 ZZ	13 000	70	180	85	83	92	115	5	3	350 000	490 000	600
200	NNTR 80X200X90 ZZ	16 800	80	200	90	88	102	127	5	3	410 000	580 000	500
220	NNTR 90X220X100 ZZ	22 500	90	220	100	98	119	146	5	3	495 000	720 000	400
240	NNTR 100X240X105 ZZ	28 000	100	240	105	103	132	160	6	6	560 000	830 000	340
260	NNTR 110X260X115 ZZ	35 600	110	260	115	113	143	174	6	6	670 000	1 020 000	300
290	NNTR 120X290X135 ZZ	52 800	120	290	135	133	155	191	8	6	890 000	1 370 000	260
310	NNTR 130X310X146 ZZ	65 200	130	310	146	144	165	204	8	6	1 020 000	1 600 000	240



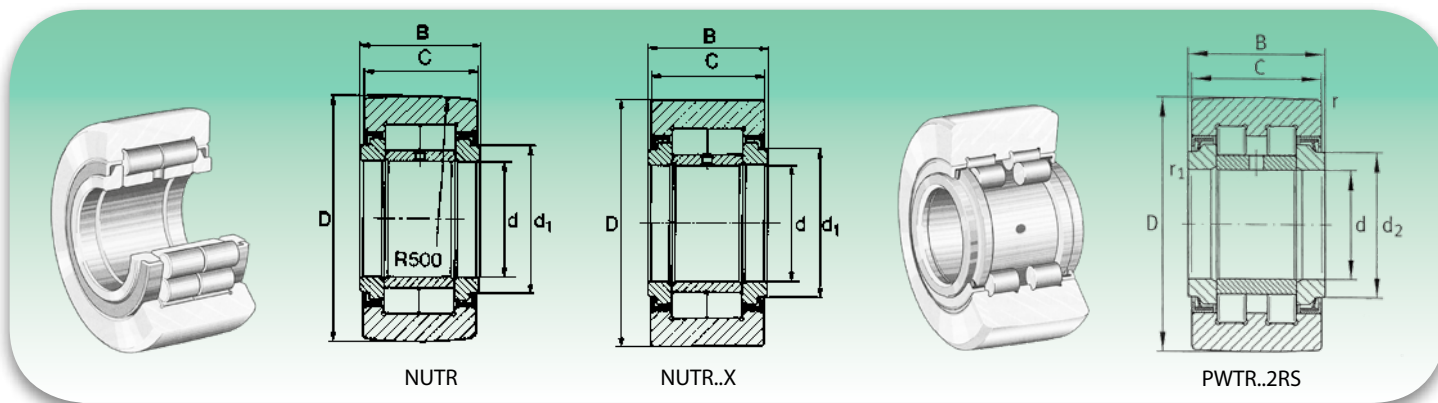

Diametro esterno (mm) Outside Diameter (mm)	Sigla Designation		Dimensioni (mm) Dimensions (mm)					Coefficienti di carico N Basic Load Rating N				Numero di giri 1) N. rpm 1) n ₀ Grasso / n ₀ Grease min ⁻¹
	Con anello interno With IR	Peso (g) Weight (g)	d	D	B	C	d ₁	Dinamico Dynamic C _w	Statico Static C ₀	Dinamico Dynamic C _w	Statico Static C _w	
35	NUTR 15 35	99	15	35	19	18	20	8 600	16 800	15 000	16 800	6 500
	PWTR 15.2RS	99	15	35	19	18	20	9 400	11 300	11 600	11 300	6 000
40	NUTR 17 40	147	17	40	21	20	22	13 100	22 600	18 400	22 600	5 500
	PWTR 17.2RS	147	17	40	21	20	22	13 800	13 800	13 200	13 800	5 000
42	NUTR 15 42	158	15	42	19	18	20	21 900	21 900	18 100	21 900	6 500
	PWTR 15 42.2RS	158	15	42	19	18	20	14 100	14 100	13 500	14 100	6 000
47	NUTR 17 47	220	17	47	21	20	22	28 000	28 000	21 300	28 000	5 500
	PWTR 17 47.2RS	220	17	47	21	20	22	16 400	16 400	14 800	16 400	5 000
	NUTR 20 47	245	20	47	25	24	27	16 400	33 000	28 000	35 000	4 200
	PWTR 20.2RS	245	20	47	25	24	27	18 300	25 500	23 200	25 500	3 800
52	NUTR 20 52	321	20	52	25	24	27	38 500	41 000	31 500	41 000	4 200
	PWTR 20 52.2RS	321	20	52	25	24	27	29 500	29 500	25 500	29 500	3 800
	NUTR 25 52	281	25	52	25	24	31	17 300	34 500	29 000	37 500	4 200
	PWTR 25.2RS	281	25	52	25	24	31	19 300	28 000	24 200	28 000	3 800
62	NUTR 25 62	450	25	62	25	24	31	50 000	50 000	35 500	50 000	4 200
	PWTR 25 62.2RS	450	25	62	25	24	31	36 000	36 000	29 000	36 000	3 800
	NUTR 30 62	465	30	62	29	28	38	23 500	46 500	40 000	50 000	2 600
	PWTR 30.2RS	465	30	62	29	28	38	25 500	39 500	35 000	39 500	2 200
72	NUTR 30 72	697	30	72	29	28	38	64 000	64 000	47 500	64 000	2 600
	PWTR 30 72.2RS	697	30	72	29	28	38	49 000	49 000	41 000	49 000	2 200
	NUTR 35 72	630	35	72	29	28	44	32 000	60 000	44 500	60 000	2 100
	PWTR 35.2RS	630	35	72	29	28	44	34 500	46 500	38 500	46 500	1 800
80	NUTR 35 80	836	35	80	29	28	44	72 000	72 000	51 000	72 000	2 100
	PWTR 35 80.2RS	836	35	80	29	28	44	55 000	55 000	43 500	55 000	1 800
	NUTR 40 80	816	40	80	32	30	50.5	30 500	60 000	55 000	75 000	1 600
	PWTR 40.2RS	816	40	80	32	30	50.5	35 000	53 000	44 500	53 000	1 500
85	NUTR 45 85	883	45	85	32	30	55.2	31 500	61 000	56 000	78 000	1 400
	PWTR 45.2RS	883	45	85	32	30	55.2	36 000	55 000	45 000	55 000	1 300
90	NUTR 40 90	1 129	40	90	32	30	50.5	84 000	95 000	66 000	95 000	1 600
	PWTR 40 90.2RS	1 129	40	90	32	30	50.5	66 000	66 000	52 000	66 000	1 500
	NUTR 50 90	950	50	90	32	30	59.8	32 000	62 000	57 000	81 000	1 300
	PWTR 50.2RS	950	50	90	32	30	59.8	37 000	57 000	45 500	57 000	1 100
100	NUTR 45 100	1 396	45	100	32	30	55.2	106 000	107 000	71 000	107 000	1 400
	PWTR 45 100.2RS	1 396	45	100	32	30	55.2	74 000	74 000	56 000	74 000	1 300
110	NUTR 50 110	1 690	50	110	32	30	59.8	120 000	120 000	76 000	120 000	1 300
	PWTR 50 110.2RS	1 690	50	110	32	30	59.8	82 000	82 000	59 000	82 000	1 100

4) Suffisso x: anello esterno cilindrico
X suffix: outer cylindrical ring



PERNI FOLLI

STUD TYPE TRACK ROLLERS

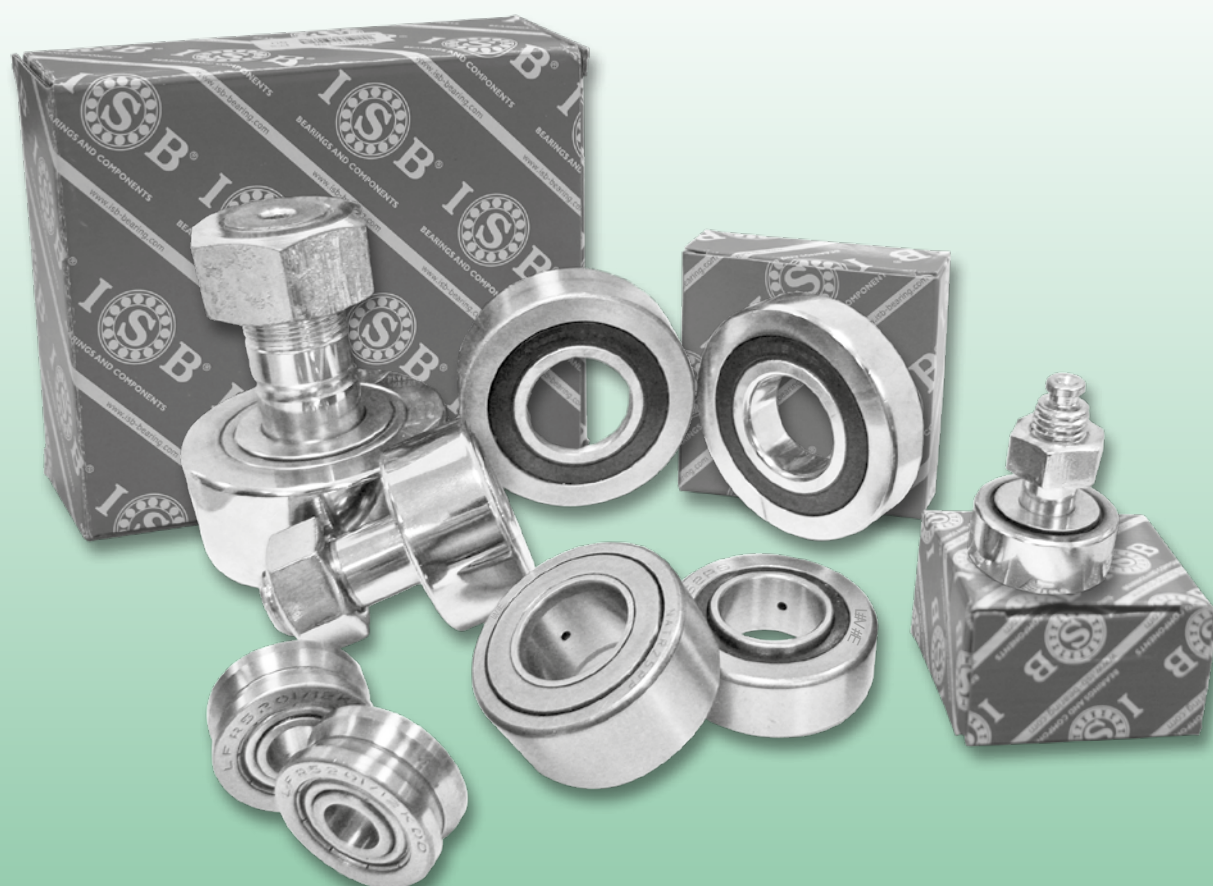



Perni folli

Stud type track rollers

I perni folli sono formati da un perno con bordo in acciaio, superfici di guida, anello esterno con uno spessore elevato, in grado di sopportare carichi radiali elevati. Grazie alla sua particolare forma dell'anello esterno (superficie bombata), il perno folle riesce a ridurre la concentrazione del carico sugli spigoli. Inoltre essendo prevista una filettatura del perno, si garantisce un facile montaggio. Per ciò che riguarda la lubrificazione, sono previsti dei fori sia sulla superficie laterale del perno che da quella del lato filettato. Quando il perno folle viene utilizzato su di una pista di rotolamento piana può verificarsi una deformazione elastica dell'anello esterno, quindi conviene utilizzare i coefficienti di carico C_w e C_{ow} come base di riferimento. I perni folli possono essere utilizzati in diverse applicazioni come rulli di pressione, rulli per bilancieri o in guide lineari semplici.

Tipologia KR e KR..PP

I perni folli costituiscono un unico gruppo di montaggio essendo formati da un perno con bordo, un anello esterno, una gabbia a rullini ed una ralla di guida. I perni folli appartenenti a questa categoria sono adatti per sopportare elevati carichi e grazie allo spazio presente tra i rullini non occorre lubrificarli molto spesso. Si ricorda che quando si utilizzano dei perni folli con anelli di tenuta non bisogna oltrepassare la temperatura compresa tra i -30°C . ed i $+80^{\circ}\text{C}$.

Tipologia KRV e KRV..PP

I perni folli della serie KRV possono essere confrontati con quelli appartenenti alla serie KR, solo che prevedono un pieno riempimento di rullini, sopportano dei carichi più elevati e raggiungono velocità di rotazione inferiori. I perni folli di questa categoria devono essere lubrificati spesso, inoltre quando sono disponibili con anelli di tenuta si rammenta di non oltrepassare le temperature massime prescritte (vedi KR)

Tipologia NUKR / PWKR

I perni folli appartenenti a questa categoria sono composti da un perno con bordo, un anello esterno con bordi guidato dai rullini, un corpo volvente costituito da rullini a pieno riempimento, tutto questo crea un' unica unità pronta per il montaggio. La tipologia di questi perni folli garantisce l'assorbimento di carichi elevati, ed anche in virtù della guida assiale presente può sopportare sforzi laterali notevoli. Si ricorda che i perni folli NUKR / PWKR hanno un'ulteriore foro di lubrificazione sul gambo. Se il foro di lubrificazione non dovesse essere utilizzato se ne consiglia la chiusura con apposito tappo. In caso d'utilizzo effettuare frequentemente la lubrificazione.

Stud type track rollers consist of a stud with a steel edge, of an outer ring with a wider thickness and of a rolling element able to stand heavy radial loads.

Thanks to the particular shape of its barrel outer ring, stud can reduce load concentration on the sharp edges; besides an easier assembling is assured by a thread which is present onto the stud.

Concerning lubrication, holes are located on both lateral surface and part of stud with thread.

When the stud is mounted on a plane guideway an elastic deformation of outer ring could happen, this is why it seems to be suitable using C_w and C_{ow} coefficients.

Stud type track rollers are used as pressure rollers, rollers for compensators or in linear guideways.

KR and KR ..PP type

Stud type track rollers are a sole group of assembling as they consist of a stud with edge, an outer ring, needle roller cage and a fifth wheel.

The KR are suitable to stand heavy loads and thanks to the space, it is not necessary to lubricate them often.

The sealed KR are thermally stable in the temperature range between -30°C $+80^{\circ}\text{C}$.

KRV and KRV..PP type

The same as above but able to stand heavier loads, lower rotation speeds and with a full complement of needle rollers.

The KRV require a frequent lubrication and seen that they can also be supplied with seals, we remind you not to exceed maximum temperature above indicated for KR.

NUKR / PWKR type

The NUKR consist of a stud, of an outer ring with edges guided by rollers, and of a full complement of needle rollers: the combination of these elements creates a sole group ready to be assembled.

Thanks to their properties, NUKR / PWKR are able to stand very heavy loads; these are axially guided to stand heavy lateral efforts. All NUKR have a further lubrication hole on their shaft: if this isn't exploited, we recommend to close it with an appropriate cap. Lubrication has to be frequently repeated.

Perni folli con eccentrico

I perni folli con eccentrico sono facilmente registrabili rispetto alle piste volventi, inoltre nel caso di montaggio di più perni si riesce a ripartire uniformemente il carico. Il rullo può essere facilmente ruotato sino ad ottenere l'eccentricità, grazie alla cava che si trova sulla superficie laterale del perno (vedere dimensione "e" nelle tabelle seguenti).

Tutti i perni folli sono già lubrificati e prevedono un foro per la rilubrificazione, posto sulla superficie laterale del perno. Gli unici perni folli che non possono essere rilubrificati dal gambo sono quelli eccentrici perché l'anello eccentrico che è stato montato impedisce il passaggio del liquido lubrificante.

Eccentric stud type track rollers

Eccentric stud type track rollers are easily registrable respect to raceways, moreover if more studs are assembled together load can be uniformly distributed

Rollers can easily rotate up to get an eccentric form, thanks to the slot inserted on lateral part of stud (see 'V' dimensions in the following tables)

All stud type track rollers are prelubricated and supplied with a lubrication hole, located on lateral side of the stud, only eccentric studs cannot be relubricated from the thread as the assembled eccentric ring avoids oil penetration.

Tipologie dei perni folli

Stud type track rollers

Tipo-Type	Caratteristiche-Characteristics
KR	Con guida assiale, tramite bordo e ralla di guida, tenuta non strisciante <i>Whit axial guide, by means of edge and guide washer, non-slippery seal</i>
KR..PP	Con anelli di tenuta <i>Whit seals</i>
KRE	Con eccentrico <i>Whit eccentric stud</i>
KRE..PP	Con eccentrici ed anelli di tenuta <i>Whit eccentric stud and seals</i>
KRV	Con guida assiale tramite bordo e ralla di guida, a pieno riempimento di rullini, tenuta non strisciante <i>Whit axial guide provided with edge and guider washer, full complement needle rollers, non slippery seal</i>
KRV..PP	A pieno riempimento di rullini, con anelli di tenuta <i>Full complement needle rollers, with seals</i>
KRVE	A pieno riempimento di rullini, con eccentrico <i>Full complement needle rollers, with eccentric stud</i>
KRVE..PP	A pieno riempimento di rullini, con eccentrici ed anelli di tenuta <i>Full complement needle rollers, with studs and seals</i>
NUKR	Con guida assiale tramite i corpi volventi, a pieno riempimento di rulli cilindrici, tenute a labirinto <i>Whit axial guide by means of rolling corps, full complement cylindrical rollers, labyrinth seals</i>
PWKR..2RS	Con guida assiale tramite i corpi volventi, a pieno riempimento di rulli cilindrici con bordo centrale, tenute a labbro schermate <i>Whit axial guide by means of rolling corps, full complement cylindrical rollers, lip seals on both sides</i>
NUKRE / PWKRE..2RS	A pieno riempimento di rulli, con eccentrico <i>Full complement cylindrical rollers and eccentric stud</i>

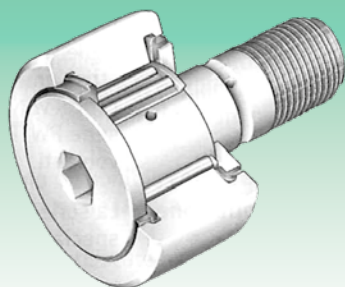

KR..-PP, KR

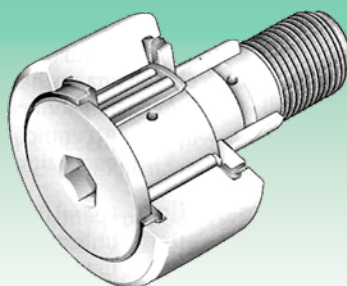

KRE..PP

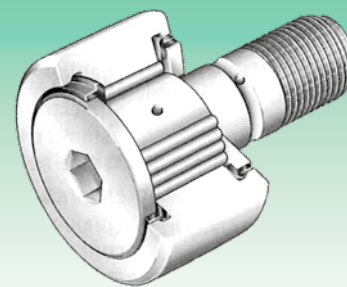

KRV..-PP

Diametro esterno (mm) Outside diameter (mm)	Sigla ¹⁾ Designation				Dimensioni (mm) Dimensions (mm)											
	Senza eccentrico Without eccentric	Peso (g) Weight (g)	Con eccentrico With eccentric	Peso (g) Weight (g)	D	d ₁ h7	B	B ₁ max	B ₂	B ₃	C	C ₁	r min.	d ₂	d ₃	
16	KR16	19	KRE16	20	16	6	28	12.2	16	-	11	0.6	0.15	12.5	-	
	KR16-PP	18	KRE16-PP	20	16	6	28	12.2	16	-	11	0.6	0.15	12.5	-	
	KRV16	18	KRVE16	22	16	6	28	12.2	16	-	11	0.6	0.15	12.5	-	
	KRV16-PP	19	KRVE16-PP	22	16	6	28	12.2	16	-	11	0.6	0.15	12.5	-	
19	KR19	29	KRE19	32	19	8	32	12.2	20	-	11	0.6	0.15	15	-	
	KR19-PP	29	KRE19-PP	32	19	8	32	12.2	20	-	11	0.6	0.15	15	-	
	KRV19	29	KRVE19	35	19	8	32	12.2	20	-	11	0.6	0.15	15	-	
	KRV19-PP	31	KRVE19-PP	35	19	8	32	12.2	20	-	11	0.6	0.15	15	-	
22	KR22	45	KRE22	47	22	10	36	13.2	23	-	12	0.6	0.3	17.5	-	
	KR22-PP	43	KRE22-PP	47	22	10	36	13.2	23	-	12	0.6	0.3	17.5	-	
	KRV22	43	KRVE22	49	22	10	36	13.2	23	-	12	0.6	0.3	17.5	-	
	KRV22-PP	45	KRVE22-PP	49	22	10	36	13.2	23	-	12	0.6	0.3	17.5	-	
26	KR26	59	KRE26	62	26	10	36	13.2	23	-	12	0.6	0.3	17.5	-	
	KR26-PP	57	KRE26-PP	62	26	10	36	13.2	23	-	12	0.6	0.3	17.5	-	
	KRV26	57	KRVE26	65	26	10	36	13.2	23	-	12	0.6	0.3	17.5	-	
	KRV26-PP	59	KRVE26-PP	65	26	10	36	13.2	23	-	12	0.6	0.3	17.5	-	
30	KR30	92	KRE30	93	30	12	40	15.2	25	6	14	0.6	0.6	23	3	
	KR30-PP	88	KRE30-PP	93	30	12	40	15.2	25	6	14	0.6	0.6	23	3	
	KRV30	88	KRVE30	94	30	12	40	15.2	25	6	14	0.6	0.6	23	3	
	KRV30-PP	91	KRVE30-PP	94	30	12	40	15.2	25	6	14	0.6	0.6	23	3	
32	KR32	103	KRE32	104	32	12	40	15.2	25	6	14	0.6	0.6	23	3	
	KR32-PP	98	KRE32-PP	104	32	12	40	15.2	25	6	14	0.6	0.6	23	3	
	KRV32	98	KRVE32	105	32	12	40	15.2	25	6	14	0.6	0.6	23	3	
	KRV32-PP	101	KRVE32-PP	105	32	12	40	15.2	25	6	14	0.6	0.6	23	3	
35	KR35	169	KRE35	181	35	16	52	19.6	32.5	8	18	0.8	0.6	27.6	3	
	KR35-PP	169	KRE35-PP	181	35	16	52	19.6	32.5	8	18	0.8	0.6	27.6	3	
	KRV35	171	KRVE35	183	35	16	52	19.6	32.5	8	18	0.8	0.6	27.6	3	
	KRV35-PP	171	KRVE35-PP	183	35	16	52	19.6	32.5	8	18	0.8	0.6	27.6	3	
40	KR40	247	KRE40	260	40	18	58	21.6	36.5	8	20	0.8	1	31.5	3	
	KR40-PP	247	KRE40-PP	260	40	18	58	21.6	36.5	8	20	0.8	1	31.5	3	
	KRV40	249	KRVE40	262	40	18	58	21.6	36.5	8	20	0.8	1	31.5	3	
	KRV40-PP	249	KRVE40-PP	262	40	18	58	21.6	36.5	8	20	0.8	1	31.5	3	

1) Anello esterno con superficie cilindrica: suffisso X. / Outer ring with cylindrical surface: X ref.

 2) C e C₀ coefficienti di carico: per utilizzo con accoppiamento con cuscinetti volventi. / C and C₀ load ratings: coupling with bearings.

3) Con lubrificazione ad olio il limite dei giri aumenta circa del 25%. / With oil lubrication, number of revolutions improves of about 25%.

4) Su richiesta, disponibili in acciaio inox 440C o 420C / Under request, stainless steel available 440C or 420C.

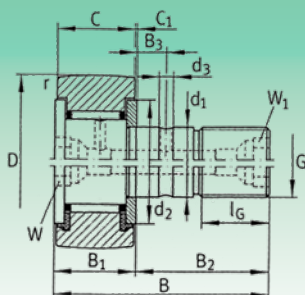
Perni folli a rullini (serie KR • KR..PP - KRV • KRV..PP - KRE • KRE..PP - KRVE • KRVE..PP)
Stud type needle track roller (KR • KR..PP - KRV • KRV..PP - KRE • KRE..PP - KRVE • KRVE..PP series)

KR..PP, KR

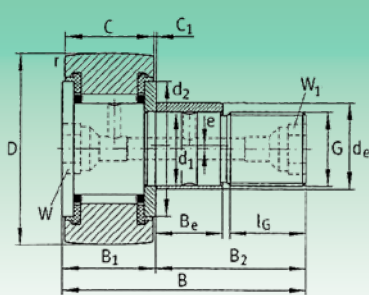

KRE..PP

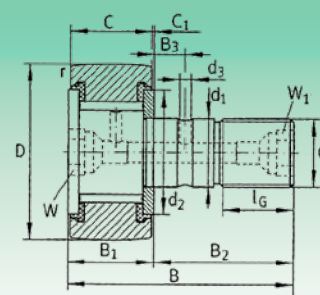

KRV..PP

Dimensioni (mm) Dimensions (mm)							Nippli ingrassatori Grease nipples	Momento di serraggio Nut tightening torque M _A N _m	Coefficienti di carico ²⁾ Basic load rating ²⁾		Carico limite di fatica Fatigue load C _{uw} N	Velocità limite Limiting speed N° giri max- N° max rpm
G	l _G	W	W ₁	Eccentrico - Eccentric					Dinamico Dynamic C _w	Statico Static C _{ow}		
				d _e h9	B _e	e						
M6(X1)	8	4	-	9	7	0.5	NIP1	3	3 150	3 300	415	14 000
M6(X1)	8	4	-	9	7	0.5	NIP1	3	3 150	3 300	415	14 000
M6(X1)	8	4	-	9	7	0.5	NIP1	3	4 900	6 500	860	3 000
M6(X1)	8	4	-	9	7	0.5	NIP1	3	4 900	6 500	860	3 000
M8(X1,25)	10	4	-	11	9	0.5	NIP1	8	3 500	3 900	485	11 000
M8(X1,25)	10	4	-	11	9	0.5	NIP1	8	3 500	3 900	485	11 000
M8(X1,25)	10	4	-	11	9	0.5	NIP1	8	5 400	7 900	1 040	3 100
M8(X1,25)	10	4	-	11	9	0.5	NIP1	8	5 400	7 900	1 040	3 100
M10X1	12	5	5	13	10	0.5	NIP1X4.5	15	4 500	5 200	650	8 000
M10X1	12	5	5	13	10	0.5	NIP1X4.5	15	4 500	5 200	650	8 000
M10X1	12	5	5	13	10	0.5	NIP1X4.5	15	6 200	9 100	1 110	2 600
M10X1	12	5	5	13	10	0.5	NIP1X4.5	15	6 200	9 100	1 110	2 600
M10X1	12	5	5	13	10	0.5	NIP1X4.5	15	5 100	6 200	770	8 000
M10X1	12	5	5	13	10	0.5	NIP1X4.5	15	5 100	6 200	770	8 000
M10X1	12	5	5	13	10	0.5	NIP1X4.5	15	7 300	11 300	1 380	2 600
M10X1	12	5	5	13	10	0.5	NIP1X4.5	15	7 300	11 300	1 380	2 600
M12X1,5	13	6	6	15	11	0.5	NIP1X4.5	22	6 800	8 400	1 070	5 500
M12X1,5	13	6	6	15	11	0.5	NIP1X4.5	22	6 800	8 400	1 070	5 500
M12X1,5	13	6	6	15	11	0.5	NIP1X4.5	22	9 500	14 600	1 840	2 100
M12X1,5	13	6	6	15	11	0.5	NIP1X4.5	22	9 500	14 600	1 840	2 100
M12X1,5	13	6	6	15	11	0.5	NIP1X4.5	22	7 100	8 900	1 140	5 500
M12X1,5	13	6	6	15	11	0.5	NIP1X4.5	22	7 100	8 900	1 140	5 500
M12X1,5	13	6	6	15	11	0.5	NIP1X4.5	22	10 500	15 800	1 990	2 100
M12X1,5	13	6	6	15	11	0.5	NIP1X4.5	22	10 500	15 800	1 990	2 100
M16X1,5	17	8	8	20	14	1	NIP2X7.5	58	9 800	14 100	1 700	3 600
M16X1,5	17	8	8	20	14	1	NIP2X7.5	58	9 800	14 100	1 700	3 600
M16X1,5	17	8	8	20	14	1	NIP2X7.5	58	12 800	23 000	2 900	1 600
M16X1,5	17	8	8	20	14	1	NIP2X7.5	58	12 800	23 000	2 900	1 600
M18X1,5	19	8	8	22	16	1	NIP2X7.5	87	10 900	15 500	1 850	2 900
M18X1,5	19	8	8	22	16	1	NIP2X7.5	87	10 900	15 500	1 850	2 900
M18X1,5	19	8	8	22	16	1	NIP2X7.5	87	14 800	26 500	3 050	1 400
M18X1,5	19	8	8	22	16	1	NIP2X7.5	87	14 800	26 500	3 050	1 400

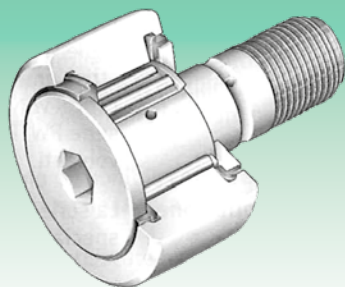

KR...PP, KR

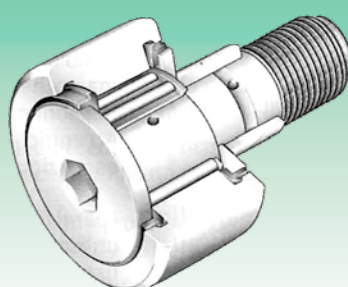

KRE..PP

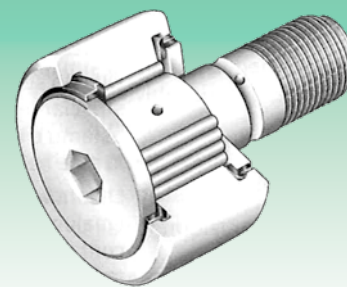

KRV..PP

Diametro esterno (mm) Outside diameter (mm)	Sigla ¹⁾ Designation				Dimensioni (mm) Dimensions (mm)										
	Senza eccentrico Without eccentric	Peso (g) Weight (g)	Con eccentrico With eccentric	Peso (g) Weight (g)	D	d ₁ h7	B	B ₁ max	B ₂	B ₃	C	C ₁	r min.	d ₂	d ₃
47	KR47	386	KRE47	400	47	20	66	25.6	40.5	9	24	0.8	1	36.5	4
	KR47-PP	386	KRE47-PP	400	47	20	66	25.6	40.5	9	24	0.8	1	36.5	4
	KRV47	390	KRVE47	409	47	20	66	25.6	40.5	9	24	0.8	1	36.5	4
	KRV47-PP	390	-	409	47	20	66	25.6	40.5	9	24	0.8	1	36.5	4
52	KR52	461	KRE52	473	52	20	66	25.6	40.5	9	24	0.8	1	36.5	4
	KR52-PP	461	KRE52-PP	473	52	20	66	25.6	40.5	9	24	0.8	1	36.5	4
	KRV52	465	KRVE52	484	52	20	66	25.6	40.5	9	24	0.8	1	36.5	4
	KRV52-PP	465	-	484	52	20	66	25.6	40.5	9	24	0.8	1	36.5	4
62	KR62	790	KRE62	798	62	24	80	30.6	49.5	11	28	0.8	1	44	4
	KR62-PP	790	KRE62-PP	798	62	24	80	30.6	49.5	11	28	0.8	1	44	4
	KRV62	802	KRVE62	830	62	24	80	30.6	49.5	11	28	0.8	1	44	4
	KRV62-PP	802	-	830	62	24	80	30.6	49.5	11	28	0.8	1	44	4
72	KR72	1 010	KRE72	1 038	72	24	80	30.6	49.5	11	28	0.8	1.1	44	4
	KR72-PP	1 010	KRE72-PP	1 038	72	24	80	30.6	49.5	11	28	0.8	1.1	44	4
	KRV72	1 045	KRVE72	1 073	72	24	80	30.6	49.5	11	28	0.8	1.1	44	4
	KRV72-PP	1 045	-	1 073	72	24	80	30.6	49.5	11	28	0.8	1.1	44	4
80	KR80	1 608	KRE80	1 665	80	30	100	37	63	15	35	1	1.1	53	4
	KR80-PP	1 608	KRE80-PP	1 665	80	30	100	37	63	15	35	1	1.1	53	4
	KRV80	1 636	KRVE80	1 900	80	30	100	37	63	15	35	1	1.1	53	4
	KRV80-PP	1 636	-	1 900	80	30	100	37	63	15	35	1	1.1	53	4
85	KR85	1 740	KRE85	2 075	85	30	100	37	63	15	35	1	1.1	53	4
	KR85-PP	1 740	KRE85-PP	2 075	85	30	100	37	63	15	35	1	1.1	53	4
90	KR90	1 950	KRE90	2 260	90	30	100	37	63	15	35	1	1.1	53	4
	KR90-PP	1 950	KRE90-PP	2 260	90	30	100	37	63	15	35	1	1.1	53	4
	KRV90	1 970	KRVE90	2 300	90	30	100	37	63	15	35	1	1.1	53	4
	KRV90-PP	1 970	-	2 300	90	30	100	37	63	15	35	1	1.1	53	4

1) Anello esterno con superficie cilindrica: suffisso X. / Outer ring with cylindric surface: X ref.

 2) C e C₀ coefficienti di carico: per utilizzo con accoppiamento con cuscinetti volventi. / C and C₀ load ratings: coupling with bearings.

3) Con lubrificazione ad olio il limite dei giri aumenta circa del 25%. / With oil lubrication, number of revolutions improves of about 25%.

4) Su richiesta, disponibili in acciaio inox 440C o 420C / Under request, stainless steel available 440C or 420C.

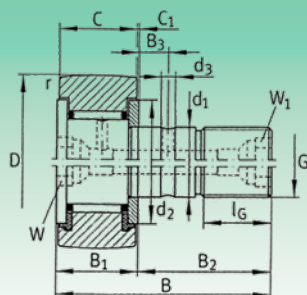
Perni folli a rullini (serie KR • KR..PP - KRV • KRV..PP - KRE • KRE..PP - KRVE • KRVE..PP)
Stud type needle track roller (KR • KR..PP - KRV • KRV..PP - KRE • KRE..PP - KRVE • KRVE..PP series)

KR..PP, KR

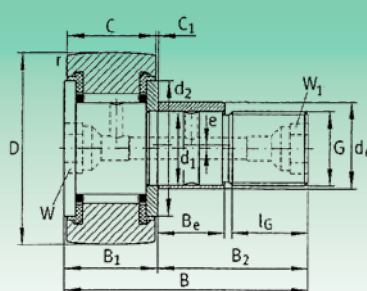

KRE..-PP

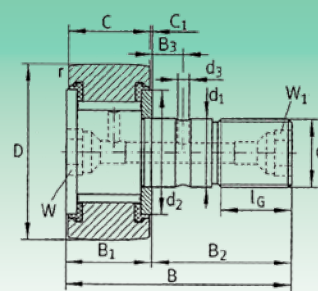

KRV..-PP

Dimensioni (mm) Dimensions (mm)							Nippli ingrassatori Grease nipples	Momento di serraggio Nut tightening torque M _A N _m	Coefficienti di carico ²⁾ Basic load rating ²⁾		Carico limite di fatica Fatigue load C _{uw} N	Velocità limite Limiting speed
G	l _G	W	W ₁	Eccentrico - Eccentric					Dinamico Dynamic C _w	Statico Static C _{ow}		
				d _e h9	B _e	e						
N° giri max - N° max rpm												
M20X1,5	21	10	10	24	18	1	NIP2X7,5	120	15 500	25 500	3 000	2 400
M20X1,5	21	10	10	24	18	1	NIP2X7,5	120	15 500	25 500	3 000	2 400
M20X1,5	21	10	10	24	18	1	NIP2X7,5	120	20 600	42 000	5 200	1 300
M20X1,5	21	10	10	24	18	1	NIP2X7,5	120	20 600	42 000	5 200	1 300
M20X1,5	21	10	10	24	18	1	NIP2X7,5	120	16 700	29 000	3 400	2 400
M20X1,5	21	10	10	24	18	1	NIP2X7,5	120	16 700	29 000	3 400	2 400
M20X1,5	21	10	10	24	18	1	NIP2X7,5	120	22 600	48 000	5 900	1 300
M20X1,5	21	10	10	24	18	1	NIP2X7,5	120	22 600	48 000	5 900	1 300
M24X1,5	25	14	14	28	22	1	NIP3X9,5	220	26 500	48 000	6 100	1 900
M24X1,5	25	14	14	28	22	1	NIP3X9,5	220	26 500	48 000	6 100	1 900
M24X1,5	25	14	14	28	22	1	NIP3X9,5	220	34 000	75 000	9 800	1 100
M24X1,5	25	14	14	28	22	1	NIP3X9,5	220	34 000	75 000	9 800	1 100
M24X1,5	25	14	14	28	22	1	NIP3X9,5	220	28 000	53 000	6 700	1 900
M24X1,5	25	14	14	28	22	1	NIP3X9,5	220	28 000	53 000	6 700	1 900
M24X1,5	25	14	14	28	22	1	NIP3X9,5	220	36 500	85 000	11 100	1 100
M24X1,5	25	14	14	28	22	1	NIP3X9,5	220	36 500	85 000	11 100	1 100
M30X1,5	32	14	14	35	29	1.5	NIP3X9,5	450	39 000	77 000	9 900	1 300
M30X1,5	32	14	14	35	29	1.5	NIP3X9,5	450	39 000	77 000	9 900	1 300
M30X1,5	32	14	14	35	29	1.5	NIP3X9,5	450	49 500	117 000	15 300	850
M30X1,5	32	14	14	35	29	1.5	NIP3X9,5	450	49 500	117 000	15 300	850
M30X1,5	32	14	14	35	29	1.5	NIP3X9,5	450	40 000	80 750	10 200	1 300
M30X1,5	32	14	14	35	29	1.5	NIP3X9,5	450	40 000	80 750	10 200	1 300
M30X1,5	32	14	14	35	29	1.5	NIP3X9,5	450	41 000	83 000	10 600	1 300
M30X1,5	32	14	14	35	29	1.5	NIP3X9,5	450	41 000	83 000	10 600	1 300
M30X1,5	32	14	14	35	29	1.5	NIP3X9,5	450	52 000	129 000	16 900	850
M30X1,5	32	14	14	35	29	1.5	NIP3X9,5	450	52 000	129 000	16 900	850

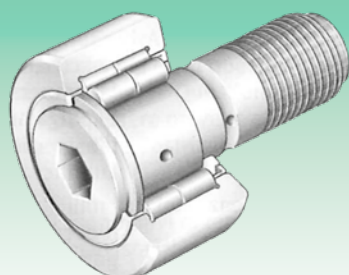

NUKR

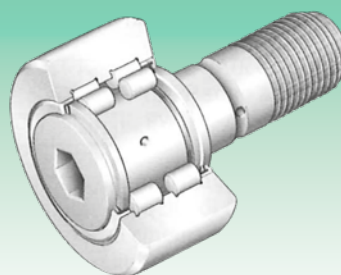

PWKR..2RS

Diametro esterno (mm) Outside Diameter (mm)	Sigla ¹⁾ Designation	Peso (g) Weight (g)	Con eccentrico With eccentric	Peso (g) Weight (g)	Dimensioni (mm) Dimensions (mm)											
					D	d ₁ h7	B	B ₁ max.	B ₂	B ₃	C	C ₁	r min.	d ₂	d ₃	G
35	NUKR35	164	-	-	35	16	52	19.6	32.5	7.8	18	0.8	0.6	20	3	M16X1,5
	-	-	NUKRE35	177	35	16	52	22.6	29.5	-	18	3.8	0.6	27.6	-	M16X1,5
	PWKR35-2RS	164	-	-	35	16	52	19.6	32.5	7.8	18	0.8	0.6	20	3	M16X1,5
	-	-	PWKRE35-2RS	177	35	16	52	22.6	29.5	-	18	3.8	0.6	27.6	-	M16X1,5
40	NUKR40	242	-	-	40	18	58	21.6	36.5	8	20	0.8	1	22	3	M18X1,5
	-	-	NUKRE40	258	40	18	58	24.6	33.5	-	20	3.8	1	30	-	M18X1,5
	PWKR40-2RS	242	-	-	40	18	58	21.6	36.5	8	20	0.8	1	22	3	M18X1,5
	-	-	PWKRE40-2RS	258	40	18	58	24.6	33.5	-	20	3.8	1	30	-	M18X1,5
47	NUKR47	380	NUKRE47	400	47	20	66	25.6	40.5	9	24	0.8	1	27	4	M20X1,5
	PWKR47-2RS	380	PWKRE47-2RS	400	47	20	66	25.6	40.5	9	24	0.8	1	27	4	M20X1,5
52	NUKR52	450	NUKRE52	470	52	20	66	25.6	40.5	9	24	0.8	1	31	4	M20X1,5
	PWKR52-2RS	450	PWKRE52-2RS	470	52	20	66	25.6	40.5	9	24	0.8	1	31	4	M20X1,5
62	NUKR62	795	NUKRE62	824	62	24	80	30.6	49.5	11	28	1.3	1	38	4	M24X1,5
	PWKR62-2RS	795	PWKRE62-2RS	824	62	24	80	30.6	49.5	11	28	1.3	1	38	4	M24X1,5
72	NUKR72	1 020	NUKRE72	1 050	72	24	80	30.6	49.5	11	28	1.3	1.1	44	4	M24X1,5
	PWKR72-2RS	1 020	PWKRE72-2RS	1 050	72	24	80	30.6	49.5	11	28	1.3	1.1	44	4	M24X1,5
80	NUKR80	1 600	NUKRE80	1 670	80	30	100	37	63	15	35	1	1.1	47	4	M30X1,5
	PWKR80-2RS	1 600	PWKRE80-2RS	1 670	80	30	100	37	63	15	35	1	1.1	47	4	M30X1,5
90	NUKR90	1 960	NUKRE90	2 020	90	30	100	37	63	15	35	1	1.1	47	4	M30X1,5
	PWKR90-2RS	1 960	PWKRE90-2RS	2 020	90	30	100	37	63	15	35	1	1.1	47	4	M30X1,5

- 1) Anello esterno con superficie cilindrica: suffisso X.
Outer ring with cylindric surface: X ref.
- 2) C e C₀ coefficienti di carico: per utilizzo con accoppiamento con cuscinetti volventi.
C and C₀ load ratings: coupling with bearings.
- 3) Con lubrificazione ad olio il limite dei giri aumenta circa del 25%.
With oil lubrication, number of revolutions improves of about 25%.
- 4) Su richiesta, disponibili in acciaio inox 440C o 420C.
Under request, stainless steel available 440C or 420C.

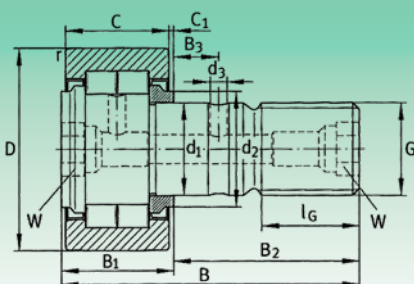
Perni folli a rulli (serie NUKR • NUKRE • PWKR..2RS • PWKRE..2RS)
Stud type track roller (NUKR • NUKRE • PWKR..2RS • PWKRE..2RS series)

NUKR

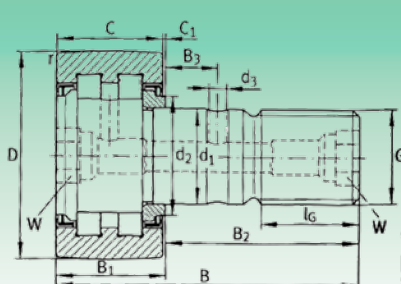

PWKR..-2RS

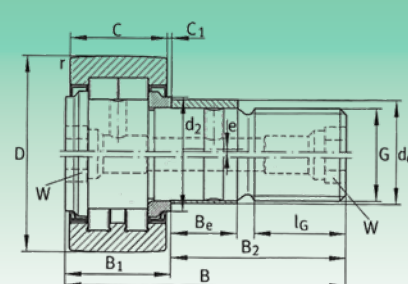
 NUKRE
PWKRE..-2RS

Dimensioni (mm) Dimensions (mm)					Nippli ingrassatori Grease nipples	Momento di serraggio Nut tightening torque M _A N _m	Coefficienti di carico ²⁾ Basic load rating ²⁾				Carico limite di fatica Fatigue load C _{uw} N	Velocità limite Limiting speed Grasso - Grease ³⁾ N° giri max - N° max rpm
l _G	W	Eccentrico - Eccentric					din. C _{r/w} N	stat. C _{0r/w} N	din. F _{r per} N	stat. F _{0r per} N		
		d _e h9	B _e	e								
17	8	-	-	-	NIPA2X7,5	58	15 000	16 800	8 600	16 800	2 220	6 500
17	8	20	12	1	NIPA2X7,5	58	15 000	16 800	8 600	16 800	2 220	6 500
17	8	-	-	-	NIPA2X7,5	58	11 600	11 300	9 400	11 300	1 780	6 000
17	8	20	12	1	NIPA2X7,5	58	11 600	11 300	9 400	11 300	1 780	6 000
19	8	-	-	-	NIPA2X7,5	87	18 400	22 600	13 100	22 600	2 900	5 500
19	8	22	14	1	NIPA2X7,5	87	18 400	22 600	13 100	22 600	2 900	5 500
19	8	-	-	-	NIPA2X7,5	87	13 200	13 800	13 800	13 800	2 200	5 000
19	8	22	14	1	NIPA2X7,5	87	13 200	13 800	13 800	13 800	2 200	5 000
21	10	24	18	1	NIPA2X7,5	120	28 000	35 000	16 400	33 000	4 400	4 200
21	10	24	18	1	NIPA2X7,5	120	23 200	25 500	18 300	25 500	3 600	3 800
21	10	24	18	1	NIPA2X7,5	120	29 000	37 500	17 300	34 500	4 700	4 200
21	10	24	18	1	NIPA2X7,5	120	24 200	28 000	19 300	28 000	3 900	3 800
25	14	28	22	1	NIPA3X9,5	220	40 000	50 000	23 500	46 500	6 300	2 600
25	14	28	22	1	NIPA3X9,5	220	35 000	39 500	25 500	39 500	5 400	2 200
25	14	28	22	1	NIPA3X9,5	220	44 500	60 000	32 000	60 000	7 600	2 600
25	14	28	22	1	NIPA3X9,5	220	38 500	46 500	46 500	46 500	6 300	2 200
32	14	35	29	1.5	NIPA3X9,5	450	69 000	98 000	47 500	96 000	12 100	1 800
32	14	35	29	1.5	NIPA3X9,5	450	56 000	70 000	53 000	70 000	9 100	1 800
32	14	35	29	1.5	NIPA3X9,5	450	79 000	117 000	77 000	117 000	14 400	1 800
32	14	35	29	1.5	NIPA3X9,5	450	63 000	82 000	82 000	82 000	10 700	1 800





ROTELLE AD UNA E DUE CORONE DI SFERE

WHEELS WITH SINGLE OR DOUBLE ROW BALLS







Rotelle ad una e due corone di sfere Wheels with single or double row balls



Le rotelle sono costruite con un'esecuzione simile a quella dei cuscinetti a sfere della serie 62, hanno però l'anello esterno di spessore maggiore.

Le rotelle a due corone di sfere, sono particolarmente adatte ad assorbire forze assiali bidirezionali, grazie al maggior numero di sfere.

Queste serie hanno un giuoco radiale C3.

Tutte le altre serie, sono normalmente costruite secondo le norme DIN, in classe di tolleranza PN, fatta eccezione per il diametro dell'anello esterno D (-0,05).

Il giuoco radiale è CN e la lubrificazione è effettuata con grasso al sapone di litio. Il suffisso U indica l'anello esterno sferico (bombato). Per il normale impiego dei cuscinetti come rotelle, si devono considerare i coefficienti di carico C_w e C_{ow} , determinati in base alla deformazione elastica dell'anello esterno del cuscinetto sotto carico.

Wheels are built according to an execution, which resembles serie 62 ball bearings'.

Yet wheels are provided with a higher outer ring.

Wheels with two rows are thought to resist bi-directional axial forces.

This can be achieved thanks to the higher number of balls. These series present a C3 radial play.

Other series are usually built according to DIN rules and present a PN tolerance class, except for the outer ring's D diameter (-0,05). The radial play is CN and lubrication is made by means of some lithium's soap grease. Suffix – U indicates the spherical external ring.

To use bearings as wheels, coefficients C_w and C_{ow} must be taken into consideration. The latter are calculated on the basis of the elastic deformation of the bearing's outer ring, when the object itself is bearing a load.

Tipologie delle rotelle ad una e due corone di sfere Wheels with single or double row balls types

Tipo-Type	Caratteristiche-Characteristics
LR 2..NPP	Ad una corona di sfere, anello esterno cilindrico, tenuta bilaterale strisciante con schermi di copertura (esec. tipo 2RS) <i>With single row balls, outer cylindrical ring, bilateral sliding seals (2RS type)</i>
LR 2.. 6.. 60.. NPPU	Ad una corona di sfere, anello esterno bombato (sferico), tenuta bilaterale strisciante con schermi di copertura (esec. tipo 2RS) <i>With single row balls, outer barrel ring (spherical), bilateral sliding seals (2RS type)</i>
LR 50.. 52.. 53.. NPPU	A due corone di sfere, anello esterno bombato (sferico), tenuta bilaterale strisciante con schermi di copertura (esec. tipo 2RS) <i>With double row balls, outer barrel ring (spherical), bilateral sliding seals (2RS type)</i>
LR 52.. KDD	A due corone di sfere, anello esterno cilindrico, con schermi di copertura (esec. tipo ZZ) <i>With double row balls, outer cylindrical ring, shielded (ZZ type)</i>
LR 52.. 53.. KDDU	A due corone di sfere, anello esterno bombato (sferico), con schermi di copertura (esec. tipo ZZ) <i>With double row balls, outer barrel ring (spherical), shielded (ZZ type)</i>



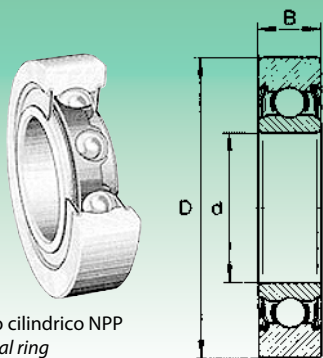
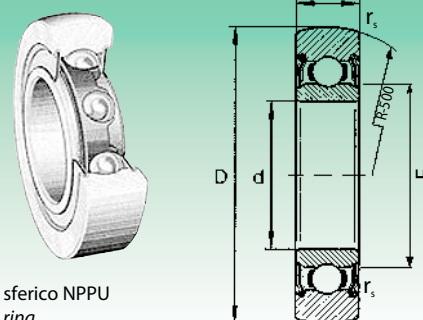

 Anello esterno cilindrico NPP
Outer cylindrical ring

 Anello esterno sferico NPPU
Outer spherical ring

Sigla Designation	Corrispondente INA Equivalent INA	Corrispondente SKF Equivalent SKF	Dimensioni (mm) Dimensions (mm)					Peso (g) Weight (g)	Coefficienti di carico effettivi (N) ¹⁾ Real Basic load rating (N) ¹⁾		Carichi radiali (N) Radial loads (N)		Velocità limite Limiting speed Grasso Grease
			d	D	B	F	r _s min		Dinamico Dynamic C _w	Statico Static C _{ow}	F _{ramm}	F _{oramm}	
LR 200 NPP	LR 200 - X - 2RS	-	10	32	9	15.4	0.6	50	4 200	2 050	4 260	4 260	12 300
LR 201 NPP	LR 201 - X - 2RS	-	12	35	10	18.3	0.6	50	5 300	2 550	4 500	4 500	11 400
LR 202 NPP	LR 202 - X - 2RS	-	15	40	11	21	0.6	70	6 250	3 200	6 600	6 600	10 400
LR 203 NPP	LR 203 - X - 2RS	-	17	47	12	24	0.6	110	8 100	4 200	8 800	8 800	8 500
LR 204 NPP	LR 204 - X - 2RS	-	20	52	14	29	1.0	150	10 000	5 400	10 700	11 200	7 600
LR 205 NPP	LR 205 - X - 2RS	-	25	62	15	33.5	1.0	230	11 900	6 700	14 200	14 200	6 600
LR 206 NPP	LR 206 - X - 2RS	-	30	72	16	37.4	1.0	330	15 800	9 200	19 200	19 200	5 200
LR 207 NPP	LR 207 - X - 2RS	-	35	80	17	42.4	1.1	400	19 500	11 500	19 500	23 800	4 200
LR 208 NPP	LR 208 - X - 2RS	-	40	85	18	48.4	1.1	450	20 400	12 200	13 400	23 100	3 750
LR 209 NPP	LR 209 - X - 2RS	-	45	90	19	53.2	1.1	500	21 300	13 000	13 300	22 800	3 400
LR 200 NPPU	LR 200 2RS	361200	10	32	9	15.4	0.6	50	4 200	2 050	4 260	4 260	12 300
LR 201 NPPU	LR 201 2RS	361201	12	35	10	18.3	0.6	50	5 300	2 550	4 500	4 500	11 400
LR 202 NPPU	LR 202 2RS	361202	15	40	11	21	0.6	70	6 250	3 200	6 600	6 600	10 400
LR 203 NPPU	LR 203 2RS	361203	17	47	12	24	0.6	110	8 100	4 200	8 800	8 800	8 500
LR 204 NPPU	LR 204 2RS	361204	20	52	14	29	1.0	150	10 000	5 400	10 700	11 200	7 600
LR 205 NPPU	LR 205 2RS	361205	25	62	15	33.5	1.0	230	11 900	6 700	14 200	14 200	6 600
LR 206 NPPU	LR 206 2RS	361206	30	72	16	37.4	1.0	330	15 800	9 200	19 200	19 200	5 200
LR 207 NPPU	LR 207 2RS	361207	35	80	17	42.4	1.1	400	19 500	11 500	19 500	23 800	4 200
LR 208 NPPU	LR 208 2RS	-	40	85	18	48.4	1.1	450	20 400	12 200	13 400	23 100	3 750
LR 209 NPPU	LR 209 2RS	-	45	90	19	53.2	1.1	500	21 300	13 000	13 300	22 800	3 400

Sigla Designation	Corrispondente INA Equivalent INA	Dimensioni (mm) Dimensions (mm)					Peso (g) Weight (g)	Coefficienti di carico effettivi (N) ¹⁾ Real Basic load rating (N) ¹⁾		Carichi radiali (N) Radial loads (N)		Velocità limite Limiting speed Grasso Grease
		d	D	B	F	r _s min		Dinamico Dynamic C _w	Statico Static C _{ow}	F _{ramm}	F _{oramm}	
LR 604 NPPU	LR 604 2RSR	4	13	4	6.1	0.2	10	860	350	700	350	22 800
LR 605 NPPU	LR 605 2RSR	5	16	5	7.5	0.2	10	1 190	490	980	490	20 900
LR 606 NPPU	LR 606 2RSR	6	19	6	8.7	0.3	10	1 740	700	1 400	1 400	19 000
LR 607 NPPU	LR 607 2RSR	7	22	6	9	0.3	10	2 130	870	1 740	1 740	19 000
LR 608 NPPU	LR 608 2RSR	8	24	7	10	0.3	20	2 750	1 250	2 500	2 500	18 000
LR 6000 NPPU	LR 6000 2RS R	10	28	8	14.6	0.3	20	3 450	2 350	2 550	3 400	16 500
LR 6001 NPPU	LR 6001 2RS R	12	30	8	16.6	0.3	30	3 650	2 600	4 100	4 100	15 400
LR 6002 NPPU	LR 6002 2RS R	15	35	9	20.1	0.3	50	4 000	3 050	4 600	4 600	14 200
LR 6003 NPPU	LR 6003 2RS R	17	40	10	22.6	0.3	70	4 550	3 450	5 980	5 980	12 800
LR 6004 NPPU	LR 6004 2RS R	20	47	12	27.6	0.6	110	5 200	3 900	4 650	7 140	11 300

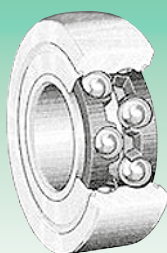
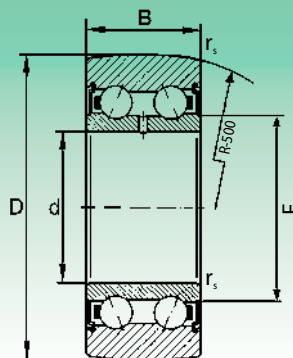
Rotelle di maggiori dimensioni a richiesta / Balls of bigger dimensions available under request

- 1) Nel caso d'utilizzo su di una camma o su di una superficie piana, è opportuno considerare i coefficienti di carico effettivi C_w e C_{ow} ed i carichi radiali F_{ramm} e F_{oramm}
 1) In case of mounting on a cam on a flat surface, please consider real load C_w and C_{ow} and radial load F_{ramm} and F_{oramm}



 Anello esterno sferico NPPU
Outer spherical ring

Sigla <i>Designation</i>	Corrispondente INA <i>Equivalent INA</i>	Dimensioni (mm) <i>Dimensions (mm)</i>					Peso (g) <i>Weight (g)</i>	Coefficienti di carico effettivi (N) ¹⁾ <i>Real Basic load rating (N)¹⁾</i>		Carichi radiali (N) <i>Radial loads (N)</i>		Velocità limite <i>Limiting speed</i>
		d	D	B	F	r _s min		Dinamico <i>Dynamic</i> C _w	Statico <i>Static</i> C _{ow}	F _{ramm}	F _{oram}	
LR 50/5 NPPU	LR 50/5 2RSR	5	17	7	8.2	0.2	10	1 660	950	1 900	1 900	11 500
LR 50/6 NPPU	LR 50/6 2RSR	6	19	9	9.3	0.3	20	2 650	1 310	2 210	2 720	10 500
LR 50/7 NPPU	LR 50/7 2RSR	7	22	10	10.5	0.3	20	3 300	1 690	3 380	3 380	9 500
LR 50/8 NPPU	LR 50/8 2RSR	8	24	11	10.5	0.3	30	4 200	2 360	3 500	4 720	9 500
LR 5000 NPPU	LR 5000 2RSR	10	28	12	13.5	0.3	30	4 750	2 850	5 300	5 700	8 550
LR 5001 NPPU	LR 5001 2RSR	12	30	12	15.5	0.3	30	4 950	3 100	5 400	6 200	8 050
LR 5002 NPPU	LR 5002 2RSR	15	35	13	20.4	0.3	50	6 500	4 100	5 300	8 200	6 700
LR 5003 NPPU	LR 5003 2RSR	17	40	14	21.6	0.3	70	7 700	5 200	10 200	10 400	5 700
LR 5004 NPPU	LR 5004 2RSR	20	47	16	25.2	0.6	120	11 500	7 700	11 000	15 400	5 250
LR 5005 NPPU	LR 5005 2RSR	25	52	16	29.8	0.6	150	11 600	8 100	10 900	16 200	4 450
LR 5006 NPPU	LR 5006 2RSR	30	62	19	35.5	1.0	250	15 800	11 800	18 200	23 600	3 800
LR 5007 NPPU	LR 5007 2RSR	35	68	20	41.7	1.0	300	17 600	13 100	14 100	26 200	4 050
LR 5008 NPPU	LR 5008 2RSR	40	75	21.9	46.7	1.0	370	18 400	14 600	20 300	29 200	4 350

Sigla <i>Designation</i>	Corrispondente INA <i>Equivalent INA</i>	Corrispondente SKF <i>Equivalent SKF</i>	Dimensioni (mm) <i>Dimensions (mm)</i>					Peso (g) <i>Weight (g)</i>	Coefficienti di carico effettivi (N) ¹⁾ <i>Real Basic load rating (N)¹⁾</i>		Carichi radiali (N) <i>Radial loads (N)</i>		Velocità limite <i>Limiting speed</i>
			d	D	B	F	r _s min		Dinamico <i>Dynamic</i> C _w	Statico <i>Static</i> C _{ow}	F _{ramm}	F _{oram}	
LR 5200 NPPU	LR 5200 2RSR	3058 00	10	32	14	15.4	0.6	70	6 800	4 050	7 700	8 100	7 600
LR 5201 NPPU	LR 5201 2RSR	3058 01	12	35	15.9	17.1	0.6	80	8 600	5 100	6 700	10 200	7 100
LR 5202 NPPU	LR 5202 2RSR	3058 02	15	40	15.9	20.0	0.6	110	9 800	6 200	10 600	12 400	6 600
LR 5203 NPPU	LR 5203 2RSR	3058 03	17	47	17.5	22.5	0.6	170	12 600	8 200	15 900	16 400	5 200
LR 5204 NPPU	LR 5204 2RSR	3058 04	20	52	20.6	26.5	1.0	230	15 800	10 500	14 600	21 000	4 600
LR 5205 NPPU	LR 5205 2RSR	3058 05	25	62	20.6	30.3	1.0	340	18 500	13 000	25 000	26 000	4 250
LR 5206 NPPU	LR 5206 2RSR	3058 06	30	72	23.8	37.4	1.0	510	24 600	21 400	29 500	35 400	3 300
LR 5207 NPPU	LR 5207 2RSR	3058 07	35	80	27	42.4	1.1	660	30 500	22 400	28 500	44 800	2 650
LR 5208 NPPU	LR 5208 2RSR	-	40	85	30.2	48.4	1.1	750	34 500	25 500	20 800	36 000	2 350
LR 5302 NPPU	LR 5302 2RSR	-	15	47	19.0	21.7	1.0	150	14 600	9 200	12 500	18 400	5 200
LR 5303 NPPU	LR 5303 2RSR	-	17	52	22.2	23.5	1.0	210	17 200	11 100	15 500	22 200	4 500
LR 5304 NPPU	LR 5304 2RSR	-	20	62	22.2	29.0	1.1	340	21 100	14 500	27 000	29 000	4 250
LR 5305 NPPU	LR 5305 2RSR	-	25	72	25.4	34.4	1.1	500	27 500	19 500	34 500	39 000	3 700
LR 5306 NPPU	LR 5306 2RSR	-	30	80	30.2	41.4	1.1	670	36 500	26 500	43 500	53 000	2 900
LR 5307 NPPU	LR 5307 2RSR	-	35	90	34.9	47.7	1.5	970	44 500	33 000	39 500	66 000	2 350
LR 5308 NPPU	LR 5308 2RSR	-	40	100	36.5	52.4	1.5	1 200	56 000	42 000	70 000	84 000	2 150

Rotelle di maggiori dimensioni a richiesta / Balls of bigger dimensions available under request

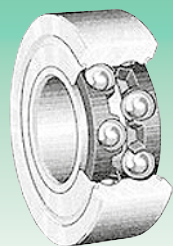
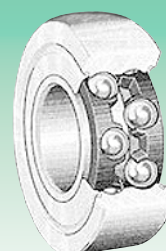
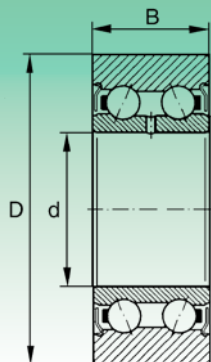
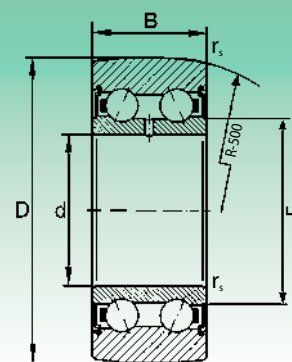
 1) Nel caso d'utilizzo su di una camma o su di una superficie piana, è opportuno considerare i coefficienti di carico effettivi C_w e C_{ow} ed i carichi radiali F_{ramm} e F_{oram}
 1) In case of mounting on a cam on a flat surface, please consider real load C_w and C_{ow} and radial load F_{ramm} and F_{oram}

 Anello esterno cilindrico KDD
Outer cylindrical ring

 Anello esterno sferico KDDU
Outer spherical ring

Sigla Designation	Corrispondente INA Equivalent INA	Corrispondente SKF Equivalent SKF	Dimensioni (mm) Dimensions (mm)					Peso (g) Weight (g)	Coefficienti di carico effettivi (N) ¹⁾ Real Basic load rating (N) ¹⁾		Carichi radiali (N) Radial loads (N)		Velocità limite Limiting speed Grasso Grease
			d	D	B	F	r _s min		Dinamico Dynamic C _w	Statico Static C _{ow}	F _{ramm}	F _{oramm}	
LR 5201 KDD	LR 5200 - X- 2Z	-	10	32	14	15.4	0.6	70	6 800	4 050	7 700	8 100	7 600
LR 5201 KDD	LR 5201 - X- 2Z	3057 01	12	35	15.9	17.1	0.6	80	8 600	5 100	6 700	10 200	7 100
LR 5202 KDD	LR 5202 - X- 2Z	3057 02	15	40	15.9	20.0	0.6	110	9 800	6 200	10 600	12 400	6 600
LR 5203 KDD	LR 5203 - X- 2Z	3057 03	17	47	17.5	22.5	0.6	170	12 600	8 200	15 900	16 400	5 200
LR 5204 KDD	LR 5204 - X- 2Z	3057 04	20	52	20.6	26.5	1.0	230	15 800	10 500	14 600	21 000	4 600
LR 5205 KDD	LR 5205 - X- 2Z	3057 05	25	62	20.6	30.3	1.0	340	18 500	13 000	25 000	26 000	4 250
LR 5206 KDD	LR 5206 - X- 2Z	3057 06	30	72	23.8	37.4	1.0	510	24 600	2 400	29 500	35 400	3 300
LR 5207 KDD	LR 5207 - X- 2Z	3057 07	35	80	27	42.4	1.1	660	30 500	22 400	28 500	44 800	2 650
LR 5208 KDD	LR 5208 - X- 2Z	-	40	85	30.2	48.4	1.1	750	34 500	25 500	20 800	36 000	2 350
LR 5200 KDDU	LR 5200 2Z	3058 00	10	32	14	15.4	0.6	70	6 800	4 050	7 700	8 100	7 600
LR 5201 KDDU	LR 5201 2Z	3058 01	12	35	15.9	17.1	0.6	80	8 600	5 100	6 700	10 200	7 100
LR 5202 KDDU	LR 5202 2Z	3058 02	15	40	15.9	20.0	0.6	110	9 800	6 200	10 600	12 400	6 600
LR 5203 KDDU	LR 5203 2Z	3058 03	17	47	17.5	22.5	0.6	170	12 600	8 200	15 900	16 400	5 200
LR 5204 KDDU	LR 5204 2Z	3058 04	20	52	20.6	26.5	1.0	230	15 800	10 500	14 600	21 000	4 600
LR 5205 KDDU	LR 5205 2Z	3058 05	25	62	20.6	30.3	1.0	340	18 500	13 000	25 000	26 000	4 250
LR 5206 KDDU	LR 5206 2Z	3058 06	30	72	23.8	37.4	1.0	510	24 600	2 400	29 500	35 400	3 300
LR 5207 KDDU	LR 5207 2Z	3058 07	35	80	27	42.4	1.1	660	30 500	22 400	28 500	44 800	2 650
LR 5208 KDDU	LR 5208 2Z	-	40	85	30.2	48.4	1.1	750	34 500	25 500	20 800	36 000	2 350

Sigla Designation	Corrispondente INA Equivalent INA	Dimensioni (mm) Dimensions (mm)					Peso (g) Weight (g)	Coefficienti di carico effettivi (N) ¹⁾ Real Basic load rating (N) ¹⁾		Carichi radiali (N) Radial loads (N)		Velocità limite Limiting speed Grasso Grease
		d	D	B	F	r _s min		Dinamico Dynamic C _w	Statico Static C _{ow}	F _{ramm}	F _{oramm}	
LR 5304 KDDU	LR 5304 2Z	20	62	22.2	29.0	1.1	340	21 100	14 500	27 000	29 000	4 250
LR 5305 KDDU	LR 5305 2Z	25	72	25.4	34.4	1.1	500	27 500	19 500	34 500	39 000	3 700
LR 5306 KDDU	LR 5306 2Z	30	80	30.2	41.4	1.1	670	36 500	26 500	43 500	53 000	2 900
LR 5307 KDDU	LR 5307 2Z	35	90	34.9	47.7	1.5	970	44 500	33 000	39 500	66 000	2 350
LR 5308 KDDU	LR 5308 2Z	40	100	36.5	52.4	1.5	1 200	56 000	42 000	70 000	84 000	2 150

Rotelle di maggiori dimensioni a richiesta / Balls of bigger dimensions available under request

- 1) Nel caso d'utilizzo su di una camma o su di una superficie piana, è opportuno considerare i coefficienti di carico effettivi C_w e C_{ow} ed i carichi radiali F_{ramm} e F_{oramm}
 1) In case of mounting on a cam on a flat surface, please consider real load C_w and C_{ow} and radial load F_{ramm} and F_{oramm}



CUSCINETTI RADIALI A RULLINI ED ASSIALI A RULLI CILINDRICI

*RADIAL NEEDLE ROLLER BEARINGS AND
AXIAL CYLINDRICAL NEEDLE ROLLER BEARINGS*

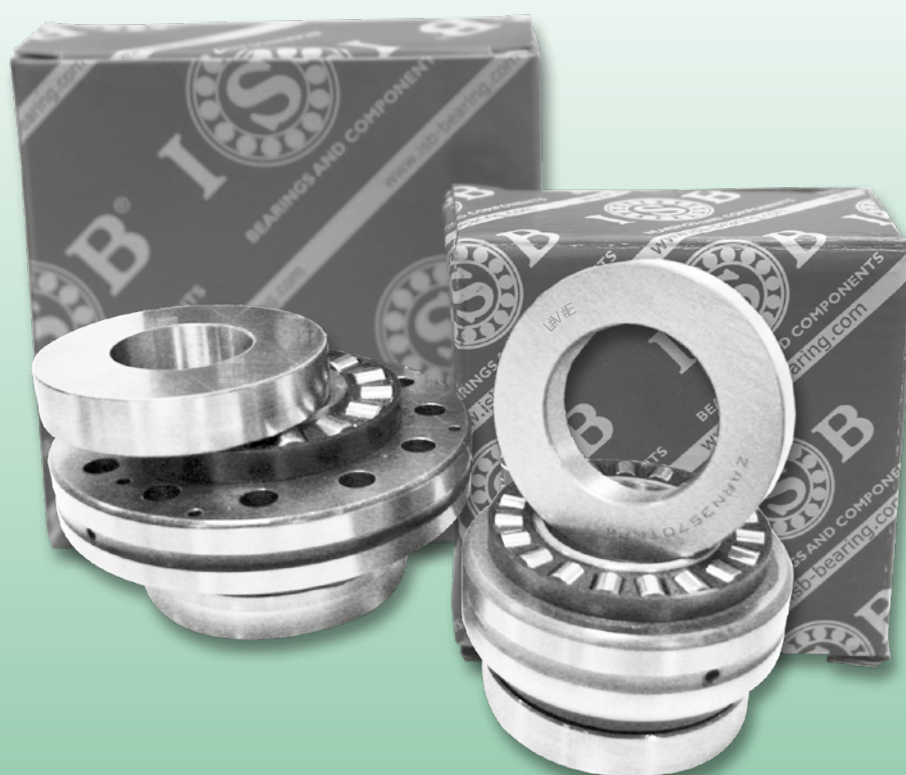



Cuscinetti radiali a rullini ed assiali a rulli cilindrici**Radial needle roller bearings and axial cylindrical needle roller bearings**

Sono particolarmente adatti in applicazioni che necessitano di un posizionamento assiale molto preciso e che devono sopportare carichi elevati. I cuscinetti radiali a rullini ZARN..L sono costituiti da un cuscinetto radiale a rullini con gabbia provvisto di anello esterno di grosso spessore, le cui facce laterali vengono quindi sfruttate come piste di rotolamento di due cuscinetti reggispira a rullini od a rulli. L'anello interno del cuscinetto radiale ritenuto lateralmente tra le ralle del reggispira, funge da distanziatore per il cuscinetto assiale.

Lo stesso concetto vale per i cuscinetti ..L, anche se la differenza principale consiste nel fatto che questi cuscinetti diversamente dai ZARN..L hanno l'anello esterno del cuscinetto radiale più alto così da formare una flangia provvista di fori per il fissaggio, inoltre sono destinati ad applicazioni con basse velocità e carichi meno elevati.

Su richiesta per questi cuscinetti possono essere forniti degli anelli di tenuta speciali, che hanno il preciso compito di fungere da protezione contro eventuali agenti esterni. Occorre prestare particolare attenzione in fase di montaggio, in quanto questi cuscinetti debbono essere necessariamente applicati su delle parti molto rigide, l'anello esterno dev'essere bloccato contro una battuta onde evitare qualsiasi tipo di spostamento assiale in fase di carico.

Per ciò che riguarda i cuscinetti ZARF..L vengono fissati sulla macchina con delle viti nei fori previsti sull'anello esterno. La lubrificazione può essere effettuata dai tre diversi lati in quanto l'unione dei tre condotti permette una lubrificazione globale. I cuscinetti della serie ZARF e ZARN sono forniti con giuoco radiale C2, le precisioni dimensionali e di forma corrispondono alla classe P6 e P4 per la parte radiale ed assiale.

These needle roller bearings are particularly suitable for applications requiring ability to stand heavy loads and a very accurate axial placing.

Radial needle roller bearings ZARN..L consist in caged radial needle bearing supplied with an outer ring having a big thickness, its lateral surfaces are used as raceways for two thrust needle bearings or roller bearings; the inner ring of radial needle roller bearing is holded sideways between the ring of the thrust bearing and it works as a spacer for the axial bearing.

A ZARF..L bearing has the same characteristic of a ZARN..L type, but it's different from it because these bearings have the outer ring of radial bearing that is higher, creating in this way a flange provided with fixation holes.

They are suitable for applications requiring low speeds and lighter loads.

Under request for these needle roller bearings special oil seals can be supplied : their special duty is to protect them from external factors.

It is very important to carefully follow assembling operations, as these bearings have to be mounted on very rigid parts: the outer ring has to be locked against one housing step, avoiding in this way any kind of axial movement while loading.

Concerning a ZARF..L bearing, it is mounted on machinery by some screw inside the holes existing on the outer ring.

Lubrication can be effectued from the three different sides, as the union of three galleries enables a total lubrication.

ZARN and ZARF are supplied with C2 radial clearance, P6 and P4 are their dimensional and shaping tolerances concerning radial and axial part.

Tipologie dei cuscinetti radiali a rullini ed assiali a rulli cilindrici**Radial needle roller bearings and axial cylindrical needle roller bearings types**

Tipo-Type	Caratteristiche-Characteristics
ZARF	Cuscinetto radiale a rullini, combinato con cuscinetti assiali a rulli cilindrici con ralla intermedia flangiabile (serie leggera e pesante). Anello esterno con fori per montaggio mediante viti. <i>Needle roller/axial cylindrical roller bearing, double direction, outer ring suitable for flange mounting, with axial preload facility (light and heavy series). Outer ring suitable for flange mounting.</i>
ZARF..L	Cuscinetto radiale a rullini, combinato con cuscinetti assiali a rulli cilindrici come ZARF, con una delle due ralle per albero estesa e profilata. Anello esterno con fori per montaggio mediante viti. <i>Needle roller/axial cylindrical roller bearing as ZARF, with stepped, extended shaft washer on one side. Outer ring suitable for flange mounting.</i>
ZARN	Cuscinetto radiale a rullini ed assiale a rulli cilindrici, a doppio effetto, precaricabile assialmente (serie leggera e pesante) <i>Radial needle roller bearings and axial cylindrical needle roller bearings, double direction, with axial preload facility (light and heavy series)</i>
ZARN..L	Cuscinetto radiale a rullini, combinato con cuscinetti assiali a rulli cilindrici come ZARN, con una delle due ralle per albero estesa e profilata <i>Needle roller/axial cylindrical roller bearing as ZARN, with stepped, extended shaft washer on one side</i>

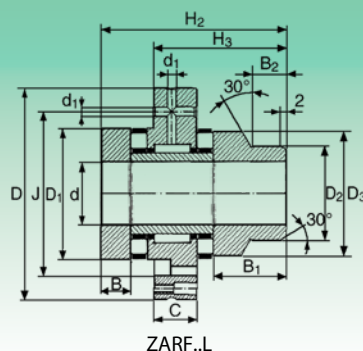
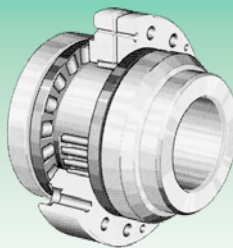
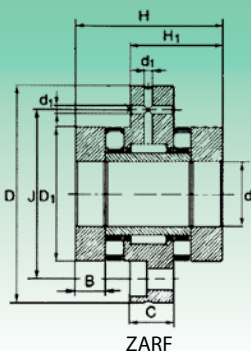
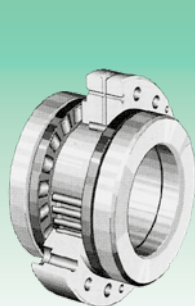

SERIE LEGGERA / LIGHT SERIES

Diametro albero (mm) Shaft Diameter (mm)	Sigla Designation	Peso (g) Weight (g)	Sigla Designation	Peso (g) Weight (g)	Dimensioni (mm) Dimensions (mm)														
					d	D	H	H ₁	H ₂	H ₃	C	D ₁	D ₂	D ₃	B	B ₁	B ₂	d ₁	J
15	ZARF 1560 TN	420	ZARF 1560 L TN	450	15	60	40	26	53	39	14	35	24	34	7.5	20.5	11	3.2	46
17	ZARF 1762 TN	490	ZARF 1762 L TN	520	17	62	43	27.5	57	41.5	14	38	28	38	9	23	11	3.2	48
20	ZARF 2068 TN	560	ZARF 2068 L TN	610	20	68	46	29	60	43	14	42	30	40	10	24	11	3.2	53
25	ZARF 2575 TN	780	ZARF 2575 L TN	840	25	75	50	33	65	48	18	47	36	45	10	25	11	3.2	58
30	ZARF 3080 TN	850	ZARF 3080 L TN	900	30	80	50	33	65	48	18	52	40	50	10	25	11	3.2	63
35	ZARF 3590 TN	1 120	ZARF 3590 L TN	1 250	35	90	54	35	70	51	18	60	45	58	11	27	12	3.2	73
40	ZARF 40100 TN	1 350	ZARF 40100 L TN	1 450	40	100	54	35	70	51	18	65	50	63	11	27	12	3.2	80
45	ZARF 45105 TN	1 700	ZARF 45105 L TN	1 850	45	105	60	40	75	55	22.5	70	56	68	11.5	26.5	12	6	85
50	ZARF 50115 TN	2 100	ZARF 50115 L TN	2 450	50	115	60	40	78	58	22.5	78	60	78	11.5	29.5	12	6	94

SERIE PESANTE / HEAVY DUTY

Diametro albero (mm) Shaft Diameter (mm)	Sigla Designation	Peso (g) Weight (g)	Sigla Designation	Peso (g) Weight (g)	Dimensioni (mm) Dimensions (mm)														
					d	D	H	H ₁	H ₂	H ₃	C	D ₁	D ₂	D ₃	B	B ₁	B ₂	d ₁	J
20	ZARF 2080 TN	1 100	ZARF 2080 L TN	1 220	20	80	60	38	75	53	18	52	40	50	12.5	27.5	11	3.2	63
25	ZARF 2590 TN	1 600	ZARF 2590 L TN	1 750	25	90	60	38	75	53	18	62	48	60	12.5	27.5	11	3.2	73
30	ZARF 30105 TN	1 950	ZARF 30105 L TN	2 150	30	105	66	41	82	57	18	68	52	66	14	30	12	3.2	85
35	ZARF 35110 TN	1 600	ZARF 35110 L TN	1 850	35	110	66	41	82	57	18	73	60	73	14	30	12	3.2	88
40	ZARF 40115 TN	2 700	ZARF 40115 L TN	3 000	40	115	75	47.5	93	65.5	22.5	78	60	78	16	34	12	6	94
45	ZARF 45130 TN	3 900	ZARF 45130 L TN	4 300	45	130	82	51	103	72	22.5	90	70	88	17.5	38.5	14	6	105
50	ZARF 50140 TN	4 200	ZARF 50140 L TN	4 650	50	140	82	51	103	72	22.5	95	75	93	17.5	38.5	14	6	113
55	ZARF 55145 TN	4 500	ZARF 55145 L TN	5 000	55	145	82	51	103	72	22.5	100	80	98	17.5	38.5	14	6	118
60	ZARF 60150 TN	4 700	ZARF 60150 L TN	5 350	60	150	82	51	103	72	22.5	105	90	105	17.5	38.5	16	6	123
65	ZARF 65155 TN	5 100	ZARF 65155 L TN	5 700	65	155	82	51	103	72	22.5	110	90	108	17.5	38.5	16	6	128
70	ZARF 70160 TN	5 200	ZARF 70160 L TN	5 950	70	160	82	51	103	72	22.5	115	100	115	17.5	38.5	16	6	133
75	ZARF 75185 TN	9 400	ZARF 75185 L TN	10 600	75	185	100	62	125	87	27	135	115	135	21	46	16	6	155
90	ZARF 90210 TN	13 700	ZARF 90210 L TN	15 100	90	210	110	69.5	135	94.5	32	160	130	158	22.5	47.5	16	8	180

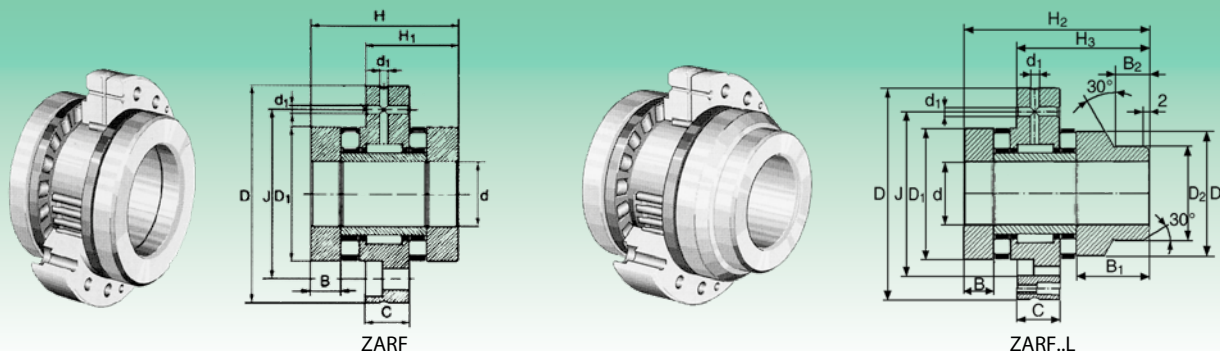
TN= Gabbia in materiale plastico, temperatura d'esercizio ammessa 80°C (per funzionamento continuo).
 TN= Plastic cage; temperature allowed: 80°C (continuous working).

Cuscinetti combinati, a rullini ed assiali a rulli cilindrici (serie ZARF • ZARF..L)
Needle roller axial cylindrical roller bearings (ZARF • ZARF..L series)

Viti di fissaggio ¹⁾ Fixing Screws		Coefficiente di carico (N) Basic Load Rating (N)				Velocità limite Limiting Speed		Coppia di attrito Bearing Frictional Torque	Rigidezza assiale Axial Rigidity	Rigidezza angolare Tilting Rigidity	Ghiera Locknut	
Filetto Thread	Quantità Quantity	Assiale / Axial		Radiale / Radial		Olio ²⁾ Oil	Grasso Grease	MRL Nm	CaL N/μm	CkL Nm/mrad	Filetto Thread	M _A Nm
		Dinamico C Dynamic C	Statico C ₀ Static C ₀	Dinamico C Dynamic C	Statico C ₀ Static C ₀	N° giri max max rpm						
M6	6	23 600	50 350	12 000	16 500	8 000	2 100	0.32	1 260	100	M15x1	10
M6	6	24 700	54 150	13 300	18 900	7 400	2 000	0.38	1 400	130	M17x1	12
M6	8	32 500	72 200	14 100	21 280	6 600	1 900	0.41	1 600	190	M20x1.5	18
M6	8	33 700	81 700	21 470	34 200	5 700	1 800	0.50	1 700	300	M25x1.5	25
M6	12	37 000	95 950	23 100	39 400	5 200	1 700	0.55	2 000	420	M30x1.5	32
M6	12	53 200	140 600	24 700	44 650	4 560	1 600	0.79	2 300	640	M35x1.5	42
M8	8	56 000	154 850	26 100	50 350	4 180	1 500	0.88	2 500	1 000	M40x1.5	55
M8	8	57 950	168 150	36 100	70 300	3 800	1 400	1.00	2 800	1 240	M45x1.5	65
M8	12	85 500	285 000	38 000	77 900	3 400	1 150	1.90	3 700	2 370	M50x1.5	85

Viti di fissaggio ¹⁾ Fixing Screws		Coefficiente di carico (N) Basic Load Rating (N)				Velocità limite Limiting Speed		Coppia di attrito Bearing Frictional Torque	Rigidezza assiale Axial Rigidity	Rigidezza angolare Tilting Rigidity	Ghiera Locknut	
Filetto Thread	Quantità Quantity	Assiale / Axial		Radiale / Radial		Olio ²⁾ Oil	Grasso Grease	MRL Nm	CaL N/μm	CkL Nm/mrad	Filetto Thread	M _A Nm
		Dinamico C Dynamic C	Statico C ₀ Static C ₀	Dinamico C Dynamic C	Statico C ₀ Static C ₀	N° giri max max rpm						
M6	12	64 000	141 000	22 600	36 000	6 000	1 500	1.3	2 300	400	M20x1	38
M6	12	80 000	199 000	24 300	41 500	4 900	1 400	1.6	3 000	800	M25x1.5	55
M8	12	107 000	265 000	26 000	47 000	4 400	1 300	2.1	3 300	1 100	M30x1.5	75
M8	12	105 000	265 000	27 500	53 000	4 000	1 250	2.3	2 500	1 300	M35x1.5	100
M8	12	117 000	315 000	38 000	74 000	3 700	1 200	2.5	3 800	1 800	M40x1.5	120
M8	12	154 000	405 000	40 000	82 000	3 300	1 150	3.5	4 000	2 100	M45x1.5	150
M10	12	172 000	480 000	42 000	90 000	3 100	1 100	3.8	4 600	2 900	M50x1.5	180
M10	12	177 000	500 000	44 000	98 000	2 900	1 000	4	4 900	3 600	M55x2	220
M10	12	187 000	550 000	44 500	92 000	2 700	950	4.2	5 300	4 300	M60x2	250
M10	12	172 000	500 000	54 000	104 000	2 600	900	4	4 800	4 000	M65x2	270
M10	12	201 000	630 000	56 000	119 000	2 400	800	4.8	5 800	6 000	M70x2	330
M12	12	290 000	890 000	72 000	132 000	2 100	700	8	6 600	8 500	M75x2	580
M12	16	325 000	1 030 000	98 000	210 000	1 800	700	10.5	7 700	14 500	M90x2	960

1) Coppia di serraggio per viti di fissaggio secondo indicazioni del produttore, le viti secondo DIN non fanno parte del programma di fornitura.
Tightening for fixation screws, as per manufacturer's indications. Screws, in accordance with DIN are not included in this sales program.

2) Numero di giri limite per lubrificazione ad olio con sufficiente olio di raffreddamento.
Number of allowed revolutions with an oil lubrication, with enough cooling oil.

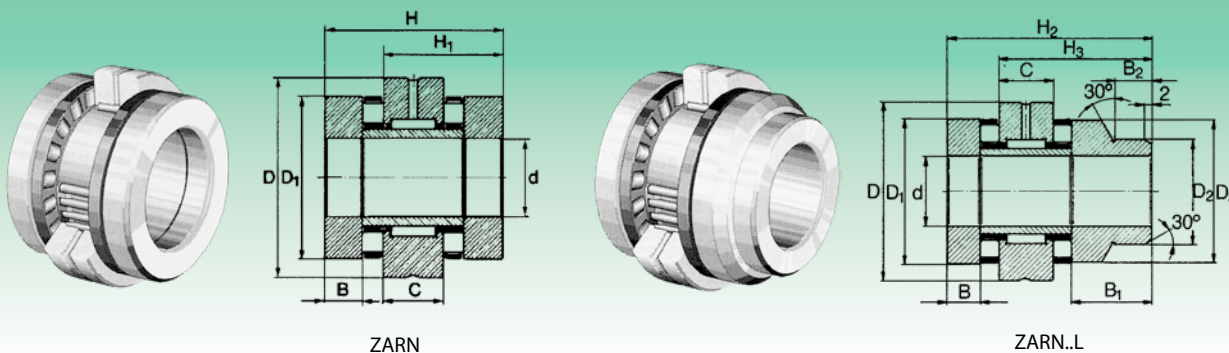
SERIE LEGGERA / LIGHT SERIES

Diametro albero (mm) Shaft Diameter (mm)	Sigla Designation	Peso (g) Weight (g)	Sigla Designation	Peso (g) Weight (g)	Dimensioni (mm) Dimensions (mm)												
					d	D	H	H ₁	H ₂	H ₃	C	D ₁	D ₂	D ₃	B	B ₁	B ₂
15	ZARN 1545 TN	340	ZARN 1545 L TN	370	15	45	40	28	53	41	16	35	24	34	7.5	20.5	11
17	ZARN 1747 TN	370	ZARN 1747 L TN	410	17	47	43	29.5	57	43.5	16	38	28	38	9	23	11
20	ZARN 2052 TN	410	ZARN 2052 L TN	460	20	52	46	31	60	45	16	42	30	40	10	24	11
25	ZARN 2557 TN	530	ZARN 2557 L TN	590	25	57	50	35	65	50	20	47	36	45	10	25	11
30	ZARN 3062 TN	600	ZARN 3062 L TN	750	30	62	50	35	65	50	20	52	40	50	10	25	11
35	ZARN 3570 TN	800	ZARN 3570 L TN	930	35	70	54	37	70	53	20	60	45	58	11	27	12
40	ZARN 4075 TN	900	ZARN 4075 L TN	1 000	40	75	54	37	70	53	20	65	50	63	11	27	12
45	ZARN 4580 TN	1 120	ZARN 4580 L TN	1 270	45	80	60	42.5	75	57.5	25	70	56	68	11.5	26.5	12
50	ZARN 5090 TN	1 430	ZARN 5090 L TN	1 780	50	90	60	42.5	78	60.5	25	78	60	78	11.5	29.5	12

SERIE PESANTE / HEAVY DUTY

Diametro albero (mm) Shaft Diameter (mm)	Sigla Designation	Peso (g) Weight (g)	Sigla Designation	Peso (g) Weight (g)	Dimensioni (mm) Dimensions (mm)												
					d	D	H	H ₁	H ₂	H ₃	C	D ₁	D ₂	D ₃	B	B ₁	B ₂
870	ZARN 2062 TN	870	ZARN 2062 L TN	990	20	62	60	40	75	55	20	52	40	50	12.5	27.5	11
1 170	ZARN 2572 TN	1 170	ZARN 2572 L TN	1 320	25	72	60	40	75	55	20	62	48	60	12.5	27.5	11
1 500	ZARN 3080 TN	1 500	ZARN 3080 L TN	1 700	30	80	66	43	82	59	20	68	52	66	14	30	12
1 650	ZARN 3585 TN	1 650	ZARN 3585 L TN	1 800	35	85	66	43	82	59	20	73	60	73	14	30	12
2 090	ZARN 4090 TN	2 090	ZARN 4090 L TN	2 390	40	90	75	50	93	68	25	78	60	78	16	34	12
3 020	ZARN 45105 TN	3 020	ZARN 45105 L TN	3 420	45	105	82	53.5	103	74.5	25	90	70	88	17.5	38.5	14
3 300	ZARN 50110 TN	3 300	ZARN 50110 L TN	3 750	50	110	82	53.5	103	74.5	25	95	75	93	17.5	38.5	14
3 500	ZARN 55115 TN	3 500	ZARN 55115 L TN	4 000	55	115	82	53.5	103	74.5	25	100	80	98	17.5	38.5	14
3 700	ZARN 60120 TN	3 700	ZARN 60120 L TN	4 850	60	120	82	53.5	103	74.5	25	105	90	105	17.5	38.5	16
4 000	ZARN 65125 TN	4 000	ZARN 65125 L TN	4 600	65	125	82	53.5	103	74.5	25	110	90	108	17.5	38.5	16
4 100	ZARN 70130 TN	4 100	ZARN 70130 L TN	4 850	70	130	82	53.5	103	74.5	25	115	100	115	17.5	38.5	16
7 900	ZARN 75155 TN	7 900	ZARN 75155 L TN	9 100	75	155	100	65	125	90	30	135	115	135	21	46	16
11 800	ZARN 90180 TN	11 800	ZARN 90180 L TN	13 200	90	180	110	72.5	135	97.5	35	160	130	158	22.5	47.5	16

TN= Gabbia in materiale plastico, temperatura d'esercizio ammessa 80°C (per funzionamento continuo).

TN= Plastic cage; temperature allowed: 80°C (continuous working).

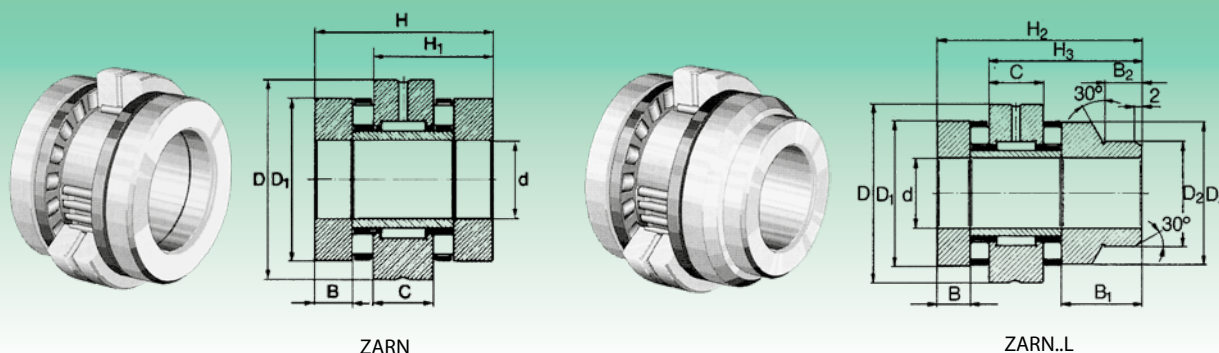
Cuscinetti combinati, a rullini ed assiali a rulli cilindrici (serie ZARN • ZARN..L)
Needle roller axial cylindrical roller bearings (ZARN • ZARN..L series)

Coefficiente di carico (N) Basic Load Rating (N)				Velocità limite Limiting Speed		Coppia di attrito Bearing Frictional Torque	Rigidezza assiale Axial Rigidity	Rigidezza angolare Tilting Rigidity	Ghiera Locknut	
Assiale / Axial		Radiale / Radial		Olio ²⁾ Oil	Grasso Grease				MRL	CaL
Dinamico C Dynamic C	Statico C ₀ Static C ₀	Dinamico C Dynamic C	Statico C ₀ Static C ₀	N° giri max max rpm		Nm	N/μm	Nm/mrad		Nm
23 600	50 350	12 000	16 500	8 000	2 100	0.32	1 260	100	M15x1	10
24 700	54 150	13 300	18 900	7 400	2 000	0.38	1 400	130	M17x1	12
32 500	72 200	14 100	21 280	6 600	1 900	0.41	1 600	190	M20x1.5	18
33 700	81 700	21 470	34 200	5 700	1 800	0.50	1 700	300	M25x1.5	25
37 000	95 950	23 100	39 400	5 200	1 700	0.55	2 000	420	M30x1.5	32
53 200	140 600	24 700	44 650	4 560	1 600	0.79	2 300	640	M35x1.5	42
56 000	154 850	26 100	50 350	4 180	1 500	0.88	2 500	1 000	M40x1.5	55
57 950	168 150	36 100	70 300	3 800	1 400	1.0	2 800	1 240	M45x1.5	65
85 500	285 000	38 000	77 900	3 400	1 150	1.9	3 700	2 370	M50x1.5	85

Coefficiente di carico (N) Basic Load Rating (N)				Velocità limite Limiting Speed		Coppia di attrito Bearing Frictional Torque	Rigidezza assiale Axial Rigidity	Rigidezza angolare Tilting Rigidity	Ghiera Locknut	
Assiale / Axial		Radiale / Radial		Olio ²⁾ Oil	Grasso Grease				MRL	CaL
Dinamico C Dynamic C	Statico C ₀ Static C ₀	Dinamico C Dynamic C	Statico C ₀ Static C ₀	N° giri max max rpm		Nm	N/μm	Nm/mrad		Nm
64 000	141 000	22 600	36 000	6 000	1 500	1.3	2 300	400	M20x1	38
80 000	199 000	24 300	41 500	4 900	1 400	1.6	3 000	800	M25x1,5	55
107 000	265 000	26 000	4 400	4 400	1 300	2.1	3 300	1 100	M30x1,5	75
105 000	265 000	27 500	53 000	4 000	1 250	2.3	-	1 300	M35x1,5	100
117 000	315 000	38 000	74 000	3 700	1 200	2.5	3 800	1 800	M40x1,5	120
154 000	405 000	40 000	82 000	3 300	1 150	3.5	4 000	2 100	M45x1,5	150
172 000	480 000	42 000	90 000	3 100	1 100	3.8	4 600	2 900	M50x1,5	180
177 000	500 000	44 000	98 000	2 900	1 000	4	4 900	3 600	M55x2	220
187 000	550 000	44 500	92 000	2 700	950	4.2	5 300	4 300	M60x2	250
172 000	500 000	54 000	104 000	2 600	900	4	4 800	4 000	M65x2	270
201 000	630 000	56 000	119 000	2 400	800	4.8	5 800	6 000	M70x2	330
290 000	890 000	72 000	132 000	2 100	700	8	6 600	8 500	M75x2	580
325 000	1 030 000	98 000	210 000	1 800	700	10.5	7 700	14 500	M90x2	960

2) Numero di giri limite per lubrificazione ad olio con sufficiente olio di raffreddamento.
Number of allowed revolutions with an oil lubrication, with enough cooling oil.

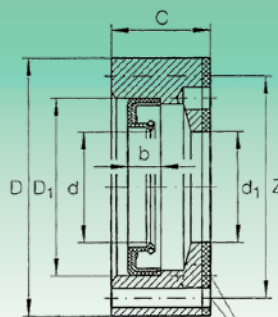
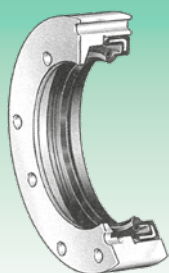

1) 4 Fori, disassati di 90°
4 Holes 90° a part

Diametro albero (mm) Shaft diameter (mm)	Sigla Designation	Peso (g) Weight (g)	Dimensioni (mm) - Dimensions (mm)				Anello di tenuta radiale - Rotary shaft seals				Relativi cuscinetti in esecuzione normale o L Designation for corresponding bearing in standard or L Sigla - Designation
			D	C	d ₁	Z	d	D ₁	b	Viti cilindriche DIN 912 4 pezzi Fixing screws DIN 912 4 pieces	
15	DRS 1560	160	60	14	35	52.4	35	45	7	M3x20	ZARF 1560 TN
17	DRS 1762	180	62	15.5	38	54.4	38	47	7	M3x25	ZARF 1762 TN
20	DRS 2068	110	68	17	42	60.4	42	55	8	M3x25	ZARF 2068 TN
	DRS 2080	200	80	22	52	73.4	52	68	8	M3x30	ZARF 2080 TN
25	DRS 2575	160	75	17	47	67.4	47	62	6	M3x25	ZARF 2575 TN
	DRS 2590	300	90	22	62	81	62	75	10	M3x30	ZARF 2590 TN
30	DRS 3080	150	80	17	52	73.4	52	68	8	M3x25	ZARF 3080 TN
	DRS 30105	350	105	25	68	95	68	85	10	M4x35	ZARF 30105 TN
35	DRS 3590	150	90	19	60	80	60	72	8	M4x25	ZARF 3590 TN
	DRS 35110	300	110	25	73	101	73	95	10	M3x30	ZARF 35110 TN
40	DRS 40100	250	100	19	65	90	65	80	8	M4x30	ZARF 40100 TN
	DRS 40115	500	115	27.5	78	106	78	100	10	M3x35	ZARF 40115 TN
45	DRS 45105	300	105	20	70	95	70	85	8	M4x30	ZARF 45105 TN
	DRS 45130	700	130	31	90	120	90	110	12	M4x40	ZARF 45130 TN
50	DRS 50115	200	115	20	78	106	78	100	10	M3x30	ZARF 50115 TN
	DRS 50140	800	140	30	95	127.5	95	115	13	M5x40	ZARF 50140 TN
55	DRS 55145	900	145	30	100	132.5	100	120	12	M5x40	ZARF 55145 TN
60	DRS 60150	900	150	30	105	137.5	105	125	12	M5x40	ZARF 60150 TN
65	DRS 65155	1 000	155	30	110	142.5	110	130	12	M5x40	ZARF 65155 TN
70	DRS 70160	1 000	160	30	115	147.5	115	135	13	M5x40	ZARF 70160 TN
75	DRS 75185	1 800	185	36	135	172.5	135	160	15	M5x50	ZARF 75185 TN
90	DRS 90210	2 700	210	38	160	194	160	180	15	M5x50	ZARF 90210 TN

1) Il portatenute viene fornito come set di tenute in singoli componenti ed è composto da:

- flangia per tenuta
- anello di tenuta radiale per albero
- tenuta flangiata
- viti cilindriche

1) The seal carrier assembly is provided with :

- seal flange
- radial seal for shaft
- flanged seal
- cylindrical screws



CUSCINETTI RADIALI A RULLI CILINDRICI A PIENO RIEMPIMENTO

CYLINDRICAL ROLLER BEARINGS, FULL COMPLEMENT ROLLER SET

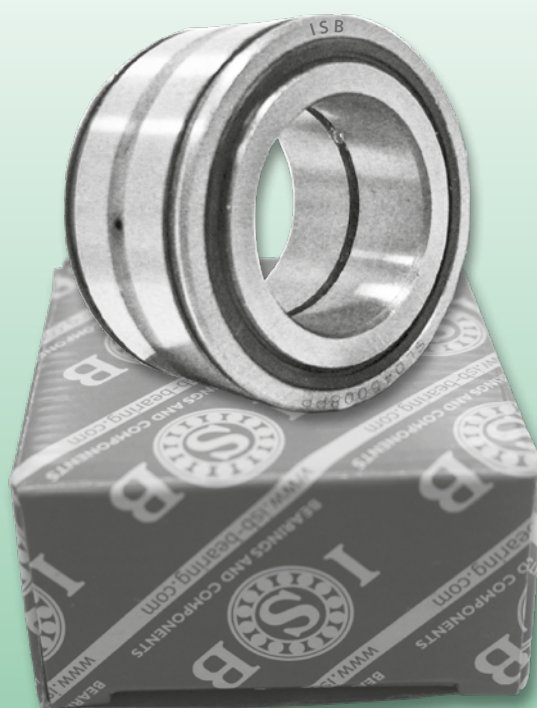



Cuscinetti radiali a rulli cilindrici a pieno riempimento

Cylindrical roller bearings, full complement roller set

I cuscinetti radiali a rulli cilindrici a pieno riempimento, sono composti da rulli cilindrici guidati sui bordi ed anelli esterni ed interni massicci.

Grazie all'elevato numero di rulli, possono assicurare coefficienti di carico dinamico e statico importanti.

Questi particolari cuscinetti risultano indicati per l'assorbimento di carichi in senso radiale e sono utilizzabili per spazi costruttivi ridotti.

I cuscinetti radiali a pieno riempimento di rulli cilindrici, sono disponibili in diverse tipologie: con cuscinetti liberi, d'appoggio, bloccati, ad una e due corone.

Quest'ultimi cuscinetti a due corone, presentano una gola e fori di lubrificazione nell'anello esterno, oltre a tenute. Nella tabella a pagina 94, sono indicate le principali caratteristiche dei cuscinetti radiali a rulli cilindrici a pieno riempimento.

Full complement cylindrical roller bearings are formed by cylindrical rollers, guided on the edge, and by massive inner and outer rings.

The great number of rollers can ensure high coefficients of dynamic and static loads.

These bearings are particularly suitable where high radial loads and small working places are present.

There are different types of full complement cylindrical roller bearings: non-located, semi-located, located, and single and double row.

Double row bearings are provided with groove and lubrication holes on the outer ring, as well as seals. The table in page 94, shows the main characteristics of full complement roller bearings.



Cuscinetti radiali a rulli cilindrici a pieno riempimento

Cylindrical roller bearings, full complement roller set



Tipologie dei cuscinetti radiali a rulli cilindrici a pieno riempimento

Cylindrical roller bearings, full complement roller set types

Tipo-Type	Caratteristiche-Characteristics
SL 18 18 SL 18 29 SL 18 30 SL 18 22 SL 19 23 SL 18 50	<p>I cuscinetti d'appoggio sono disponibili ad una corona ed a due corone per la serie 18 50, trasmettono carichi radiali elevati ed anche carichi assiali unidirezionali, guidando pertanto l'albero assialmente in un'unica direzione. Nell'altra direzione agiscono come cuscinetti liberi. La serie 19 23, si differenzia per un bordino sull'anello interno; questo dettaglio agevola le operazioni di montaggio e smontaggio. Questi cuscinetti sono forniti non schermati e non lubrificati. La lubrificazione può avvenire con olio o grasso e possono raggiungere temperature comprese tra: -30 °C a + 120 °C.</p> <p><i>Semi-locating bearings are available in single row or in double row for series 18 50, and can bear high radial loads and unidirectional axial loads, guiding therefore the shaft axially in one direction. In the other direction they act as non-locating bearings. Series 19 23 has only one edge on the inner ring, and this allows an easier mounting and dismounting operations. These bearings are supplied without seals and lubrication. Lubrication can be effected with oil or grease. Working temperature can range between -30 °C and +120 °C.</i></p>
SL 02 48 SL 02 49	<p>I cuscinetti mobili e/o liberi, sono disponibili a due corone e trasmettono esclusivamente carichi radiali. L'anello esterno privo di bordino rispetto all'anello interno può essere spostato assialmente in entrambe le direzioni. Questi cuscinetti sono forniti non schermati e non lubrificati. La lubrificazione può avvenire con olio o grasso, attraverso una scanalatura e dei fori; possono raggiungere temperature comprese tra: -30 °C a + 120 °C. Così come per i cuscinetti d'appoggio, sull'anello esterno è presente un elemento di fissaggio che ne assicura, durante la manipolazione del cuscinetto (movimentazione e montaggio) l'integrità. L'elemento utilizzato per il fissaggio non deve essere caricato assialmente.</p> <p><i>Non-locating bearings are available in double row and can only bear radial loads. The outer ring has no edge compared to inner ring and can therefore be moved axially in both directions. These bearings are supplied without seals and lubrication. They can be lubricated with oil or grease through lubrication groove and holes their working temperature can range between: -30 °C and +120 °C. As well as semi-locating bearings, they have a fixing device on the outer ring, which can protect the bearing during handling and assembling operations. The fixing device must not be subject to axial loads.</i></p>
SL 01 48 SL 01 49	<p>I cuscinetti fissi e/o bloccati a due corone, sono in grado di assorbire forze radiali ed assiali in entrambe le direzioni. L'anello esterno presenta bordini su entrambi i lati, è suddiviso assialmente ma trattenuto da agenti di bloccanti. Anche questi cuscinetti sono forniti non schermati e non lubrificati. La lubrificazione può avvenire con olio o grasso, attraverso una scanalatura e dei fori; possono raggiungere temperature comprese tra: -30 °C a + 120 °C.</p> <p><i>Double row locating bearings can bear radial and axial loads in both directions. Outer ring has edges on both sides, is axially split and blocked by fixing devices. These bearings are supplied without seals and lubrication. Lubrication can be effected with oil or grease through lubrication groove and holes. Their working temperature can range between: -30 °C and +120 °C.</i></p>
SL 04 50..-PP SL 04..-PP	<p>I cuscinetti a rulli cilindrici con gole per anelli elastici, sono a due corone a pieno riempimento; sono prevalentemente indicati al supporto di pulegge per funi. Questi cuscinetti possono assorbire forze radiali ed assiali bidirezionali. Tutti i componenti (anello interno, corpi volventi, anello esterno) costituiscono un unico gruppo non scindibile, insieme alle tenute bilaterali, che assicurano protezione da agenti inquinanti esterni. ©Le temperature possono oscillare da: -30 °C a + 80 °C. I cuscinetti a rulli cilindrici con gole per anelli elastici, sono forniti già ingrassati, tramite un grasso al sapone di litio, tuttavia attraverso l'anello esterno dov'è presente una gola e dei fori di lubrificazione, possono essere ri-lubrificati. Occorre prestare molta attenzione in fase di montaggio e smontaggio affinché non si agisca forzando, gli elementi di trattenuta dell'anello interno in due metà, i corpi volventi e gli anelli di tenuta. Per questo particolare cuscinetto sono indicati gli anelli elastici del tipo AES e gli anelli di bloccaggio secondo DIN 471.</p> <p><i>Cylindrical roller bearings with snap ring grooves are full complement double row bearing; they are particularly suitable for wire rope pulleys. These bearings can bear radial and axial loads from both directions. All parts (inner ring, rollers, outer ring) form a entire group that can not be divided, together with the seals on both sides, which protect from contaminating agents. Working temperatures range from -30 °C to + 80 °C. Cylindrical roller bearings with snap ring grooves are lubricated with a lithium soap grease. However, they can be re-lubricated through the groove and lubrication holes present on outer ring. Assembling and disassembling should be carried out very carefully, in order to avoid any damaging of inner half-rings and their retainer ring (circlip), as well as rollers and seals. These particular bearing requires elastic rings AES and blocking rings DIN 471, supplied on request.</i></p>
LSL 1923	<p>I cuscinetti radiali a rulli cilindrici ad attrito ridotto con gabbia a disco</p> <p><i>Cylindrical roller bearings, semi-locating bearing with disc cage</i></p>
ZSL 1923	<p>I cuscinetti radiali a rulli cilindrici ad attrito ridotto con distanziali</p> <p><i>Cylindrical roller bearings, semi-locating bearing with spacers</i></p>

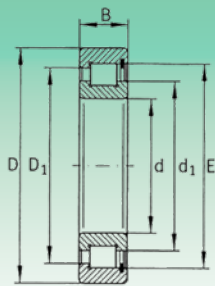
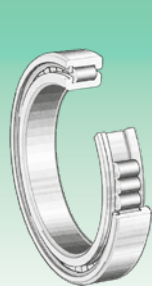

SL1829, SL1830, SL1822

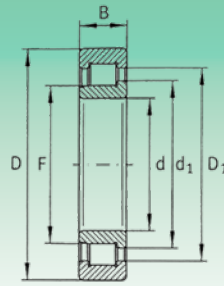
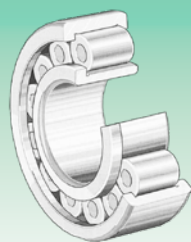

SL1923

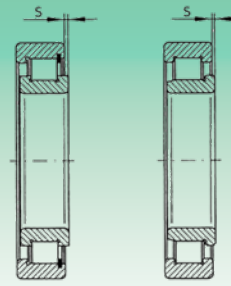
 Spostamento assiale «s»
 Axial displacement distance «s»

Diametro albero (mm) Shaft Diameter (mm)	Sigla Designation	Peso (g) Weight (g)	Dimensioni (mm) Dimensions (mm)				Dimensioni di montaggio (mm) Mounting dimensions (mm)				Coefficienti di carico (N) Basic Load Rating (N)		Velocità limite Limiting Speed
			d	D	B	s	F	d ₁	D ₁	E	Dinamico C Dynamic C	Statico C ₀ Static C ₀	
20	SL183004	110	20	42	16	1.5	–	28.8	32.8	36.81	26 200	25 100	9 500
	SL182204	160	20	47	18	1	–	30.3	36.9	41.47	39 000	35 600	9 025
25	SL183005	120	25	47	16	1.5	–	34.6	38.5	42.51	30 000	30 800	8 550
	SL182205	180	25	52	18	1	–	35.3	41.9	46.52	43 700	42 700	8 075
30	SL192305	370	25	62	24	2	31.72	36.7	47.5	–	61 700	57 000	7 125
	SL183006	200	30	55	19	2	–	40	45.4	49.6	38 500	40 800	7 125
	SL182206	300	30	62	20	1	–	42	50.6	55.19	59 800	61 700	6 650
35	SL192306	560	30	72	27	2	38.3	43.5	56	–	84 500	83 600	6 175
	SL183007	260	35	62	20	2	–	44.9	51.3	55.52	47 000	52 200	6 175
	SL182207	440	35	72	23	1	–	47	59.3	63.97	75 000	75 000	5 700
40	SL192307	740	35	80	31	2	44.68	50.7	65.8	–	107 300	106 400	5 225
	SL183008	310	40	68	21	2	–	50.5	57.1	61.74	56 000	64 600	5 700
	SL182208	550	40	80	23	1	–	54	66.3	70.94	82 600	78 800	5 225
45	SL192308	1 010	40	90	33	2	51.12	57.5	75.2	–	144 400	148 200	4 750
	SL183009	400	45	75	23	2	–	55.3	62.2	66.85	59 800	72 200	5 225
	SL182209	590	45	85	23	1	–	57.5	69.8	74.43	85 500	94 000	4 750
50	SL192309	1 370	45	100	36	3	56.1	62.5	80.3	–	153 900	163 400	4 275
	SL183010	430	50	80	23	2	–	59.1	67.7	72.33	75 000	91 200	4 750
	SL182210	640	50	90	23	1	–	64.4	76.7	81.4	92 100	107 300	4 370
55	SL192310	1 810	50	110	40	3	60.72	68.3	89.7	–	197 600	208 000	3 900
	SL183011	640	55	90	26	2	–	68.5	78.8	83.54	101 600	131 100	4 275
	SL182211	870	55	100	25	1	–	70	84.1	88.81	118 700	142 500	4 000
60	SL192311	2 280	55	120	43	3	67.11	75.5	99.3	–	229 900	242 200	3 500
	SL182912	290	60	85	16	1	–	69	74.4	78.55	54 100	74 100	4 275
	SL183012	690	60	95	26	2	–	71.7	82.1	86.74	104 500	137 700	4 000
65	SL182212	1 180	60	110	28	1.5	–	76.8	93.9	99.17	144 400	171 000	3 600
	SL192312	2 880	60	130	46	3	73.62	82	105.8	–	247 000	266 000	3 200
	SL182913	310	65	90	16	1	–	75.7	81	85.24	57 000	81 700	4 000
70	SL183013	730	65	100	26	2	–	78.1	88.4	93.09	110 200	151 000	3 700
	SL182213	1 570	65	120	31	1.5	–	82.3	100.7	106.25	169 100	203 300	3 325
	SL192313	3 520	65	140	48	3.5	80.69	90	116.5	–	299 200	337 200	3 050
75	SL182914	490	70	100	19	1	–	81.2	87.8	92.31	75 000	108 300	3 600
	SL183014	1 020	70	110	30	3	–	81.5	95.6	100.28	130 100	167 200	3 420
	SL182214	1 660	70	125	31	1.5	–	87	105.2	111.45	174 800	215 600	3 150
	SL192314	4 330	70	150	51	3.5	84.14	93.5	121.6	–	327 700	370 500	2 750

Cuscinetti radiali a rulli cilindrici a pieno riempimento, ad una corona, cuscinetti di appoggio

Cylindrical roller bearings, full complement roller set, single row, semi-locating bearings

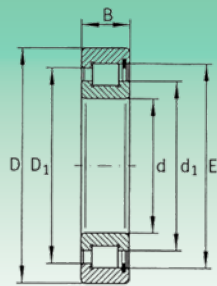
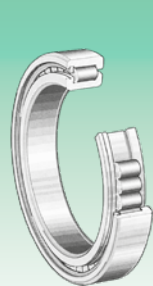

SL1829, SL1830, SL1822

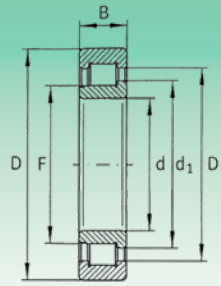
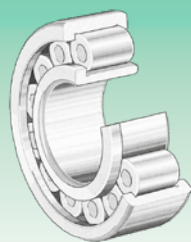

SL1923

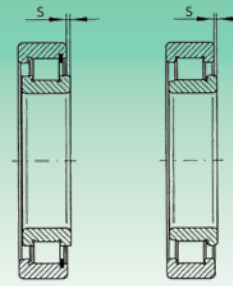
 Spostamento assiale «s»
 Axial displacement distance «s»

Diametro albero (mm) Shaft Diameter (mm)	Sigla Designation	Peso (g) Weight (g)	Dimensioni (mm) Dimensions (mm)				Dimensioni di montaggio (mm) Mounting dimensions (mm)				Coefficienti di carico (N) Basic Load Rating (N)		Velocità limite Limiting Speed
			d	D	B	s	F	d ₁	D ₁	E	Dinamico C Dynamic C	Statico C ₀ Static C ₀	
75	SL182915	520	75	105	19	1	–	86.3	92.8	97.41	77 000	115 000	3 420
	SL183015	1 060	75	115	30	3	–	89	103.2	107.9	137 700	184 300	3 230
	SL182215	1 750	75	130	31	1.5	–	91.8	110	116.2	180 500	229 000	3 040
	SL192315	5 300	75	160	55	3.5	91.22	101.6	131.5	–	389 500	451 200	2 660
80	SL182916	550	80	110	19	1	–	91.4	98	102.51	79 800	122 500	3 230
	SL183016	1 430	80	125	34	4	–	95	111.7	117.4	164 300	213 700	3 040
	SL182216	2 150	80	140	33	1.5	–	98.6	119.3	126.3	214 700	270 700	2 750
	SL192316	6 320	80	170	58	3.5	98.24	109.5	142.1	–	456 000	532 000	2 470
85	SL182917	810	85	120	22	1	–	96.4	105	109.58	99 700	153 900	3 040
	SL183017	1 510	85	130	34	4	–	99.4	116.1	121.25	169 100	225 100	2 850
	SL182217	2 740	85	150	36	1.5	–	104.4	126.3	133.75	242 200	308 700	2 660
	SL192317	7 340	85	180	60	4	107.01	118.2	150.9	–	484 500	589 000	2 000
90	SL182918	840	90	125	22	1	–	102	110.7	115.75	103 500	163 400	2 850
	SL183018	1 970	90	140	37	4	–	106.1	124.5	130.65	197 600	266 000	2 660
	SL182218	3 480	90	160	40	2.5	–	110.2	133.3	141.15	275 500	351 500	2 470
	SL192318	8 830	90	190	64	4	105.26	117.5	152.5	–	532 000	627 000	2 185
95	SL182919	860	95	130	22	1	–	106.7	117	122.25	112 100	170 000	2 750
	SL182219	4 170	95	170	43	2.5	–	122	147.3	155.95	323 000	413 200	2 280
	SL192319	1 020	95	200	67	4	114.65	126.6	161.9	–	551 000	684 000	2 090
100	SL182920	1 140	100	140	24	1.5	–	113.4	125.7	130.95	129 200	195 700	2 565
	SL183020	2 150	100	150	37	4	–	115.7	134	140.2	208 000	294 500	2 470
	SL182220	5 130	100	180	46	2.5	–	127.5	154.3	163.35	375 200	494 000	2 185
	SL192320	13 000	100	215	73	4	119.3	132.7	172.8	–	674 500	817 000	2 000
110	SL182922	1 230	110	150	24	1.5	–	124	136.2	141.5	133 000	190 000	2 375
	SL183022	3 500	110	170	45	5.5	–	127.3	149.3	156.7	270 700	375 200	2 185
	SL182222	7 240	110	200	53	4	–	137	168	177.6	432 200	560 500	2 000
	SL192322	17 000	110	240	80	5	134.27	151.1	199.9	–	807 500	931 000	1 800
120	SL182924	1 730	120	165	27	1.5	–	134.8	149	154.3	171 000	280 200	2 185
	SL183024	3 800	120	180	46	5.5	–	138.8	160.7	168.15	285 000	413 200	2 090
	SL182224	9 080	120	215	58	4	–	150.7	183	192.9	513 000	693 500	1 800
	SL192324	22 300	120	260	86	5	147.39	164.2	213.1	–	1 130 000	1 178 000	1 615
130	SL182926	2 330	130	180	30	2	–	146	161.1	167.15	238 000	337 500	2 000
	SL183026	5 650	130	200	52	5.5	–	148.6	175.5	184.4	435 000	589 000	1 900
	SL182226	11 250	130	230	64	5	–	162.3	197	207.75	630 000	817 000	1 710

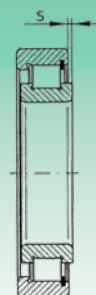
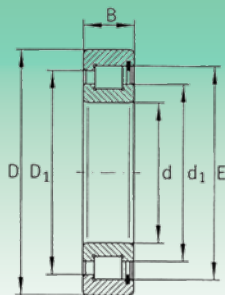

SL1818, SL1829, SL1830, SL1822

 «s» Spostamento assiale «s»
 Axial displacement distance «s»

Diametro albero (mm) Shaft Diameter (mm)	Sigla Designation	Peso (g) Weight (g)	Dimensioni (mm) Dimensions (mm)				Dimensioni di montaggio (mm) Mounting dimensions (mm)			Coefficienti di carico (N) Basic Load Rating (N)		Velocità limite Limiting Speed
			d	D	B	s	d ₁	D ₁	E	Dinamico C Dynamic C	Statico C ₀ Static C ₀	
140	SL182928	2 420	140	190	30	2	157	174	180	220 000	365 000	1 900
	SL183028	6 040	140	210	53	5.5	162.2	189.5	198.4	432 000	646 000	1 805
	SL182228	14 470	140	250	68	5	173.9	211.1	222.55	684 000	969 000	1 615
150	SL182930	3 770	150	210	36	2.5	169	189.6	196.75	289 000	465 000	1 710
	SL183030	7 330	150	225	56	7	170	198	207.45	456 000	674 000	1 615
	SL182230	18 430	150	270	73	6	185.5	225.2	237.35	788 000	1 121 000	1 425
160	SL182932	4 000	160	220	36	2.5	179.7	200.5	207.6	304 000	494 000	1 615
	SL183032	8 800	160	240	60	7	184.8	215.8	225.45	522 000	779 000	1 520
	SL182232	23 000	160	290	80	6	208.7	253.4	267.1	978 000	1 415 000	1 330
170	SL182934	4 300	170	230	36	2.5	190.6	211.3	218.45	313 000	532 000	1 520
	SL183034	12 200	170	260	67	7	198.1	232.7	243.55	674 000	1 016 000	1 425
	SL182234	28 650	170	310	86	7	220.3	267.4	281.9	1 092 000	1 596 000	1 330
180	SL182936	6 200	180	250	42	3	200.7	224	231.85	389 000	655 000	1 425
	SL183036	16 100	180	280	74	7	212.2	249.4	261	779 000	1 197 000	1 330
	SL182236	29 800	180	320	86	7	232.4	279.5	294	1 130 000	1 691 000	1 235
190	SL182938	6 500	190	260	42	2	211.5	238.5	244.15	432 000	750 000	1 330
	SL183038	17 000	190	290	75	9	221.8	259	270.6	798 000	1 254 000	1 330
	SL182238	35 650	190	340	92	9	243.5	295.5	311.5	1 244 000	1 824 000	1 140
200	SL181840	2 570	200	250	24	2	216.6	231.6	237.6	173 000	313 000	1 330
	SL182940	9 100	200	280	48	3	225.5	252.4	261.6	522 000	912 000	1 330
	SL183040	21 800	200	310	82	9	236.6	276.2	288.6	912 000	1 453 000	1 235
	SL182240	43 120	200	360	98	9	246.6	302.4	319.4	1 349 000	1 938 000	1 140
220	SL181844	2 800	220	270	24	2	237.3	252.3	258.5	182 000	346 000	1 235
	SL182944	9 900	220	300	48	3	246.3	273.2	282.45	551 000	997 000	1 140
	SL183044	28 400	220	340	90	9	254.6	299.2	312	1 102 000	1 748 000	1 140
240	SL181848	4 290	240	300	28	2	260.5	281	287.5	212 000	413 000	1 140
	SL182948	10 600	240	320	48	3	267.5	294.4	303.7	579 000	1 083 000	1 140
	SL183048	30 900	240	360	92	11	277.5	322.1	336	1 159 000	1 909 000	1 045
260	SL181852	4 610	260	320	28	2	281	301.5	308	222 000	451 000	1 045
	SL182952	18 500	260	360	60	5	291.5	323.4	333.7	750 000	1 396 000	950
	SL183052	44 500	260	400	104	11	304	358.4	375.97	1 539 000	2 422 000	950
280	SL181856	6 890	280	350	33	2.5	304	327	335	299 000	589 000	950
	SL182956	19 700	280	380	60	3.5	314	348.5	359.5	874 000	1 653 000	950
	SL183056	48 000	280	420	106	11	319.5	372.9	390.3	1 586 000	2 565 000	900

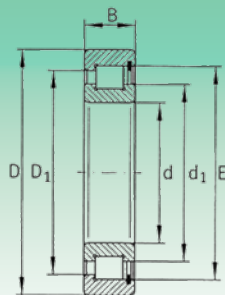
Cuscinetti radiali a rulli cilindrici a pieno riempimento, ad una corona, cuscinetti di appoggio
Cylindrical roller bearings, full complement roller set, single row, semi-locating bearings

SL1818, SL1829, SL1830, SL1822

¹⁾ Spostamento assiale «s»
Axial displacement distance «s»

Diametro albero (mm) Shaft Diameter (mm)	Sigla Designation	Peso (g) Weight (g)	Dimensioni (mm) Dimensions (mm)				Dimensioni di montaggio (mm) Mounting dimensions (mm)			Coefficienti di carico (N) Basic Load Rating (N)		Velocità limite Limiting Speed
			d	D	B	s ¹	d ₁	D ₁	E	Dinamico C Dynamic C	Statico C ₀ Static C ₀	
300	SL181860	9 790	300	380	38	3	323.5	350.5	360	361 000	712 000	900
	SL182960	31 200	300	420	72	5	338	376.9	389.45	1 121 000	2 118 000	855
	SL183060	66 600	300	460	118	14	353.6	415.6	434.85	1 938 000	3 182 000	805
320	SL181864	10 360	320	400	38	3	344.5	371.5	381	370 000	760 000	855
	SL182964	32 900	320	440	72	5	358.5	397.4	409.85	1 159 000	2 251 000	805
	SL183064	71 700	320	480	121	14	369.5	430.1	449.5	1 995 000	3 325 000	760
340	SL181868	10 930	340	420	38	3	365.5	392.5	402.2	384 000	789 000	805
	SL182968	34 700	340	460	72	5	379	418.5	430.2	1 197 000	2 375 000	760
	SL183068	95 800	340	520	133	16	396.1	463.9	485.65	2 375 000	3 942 000	710
360	SL181872	11 490	360	440	38	3	387	413.5	423.5	404 000	845 000	760
	SL182972	36 400	360	480	72	5	399.5	438.6	450.6	1 225 000	2 517 000	710
	SL183072	101 000	360	540	134	16	414	481.6	503.45	2 422 000	4 132 000	665
380	SL181876	18 870	380	480	46	4	415.5	448	459	560 000	1 130 000	710
	SL182976	52 100	380	520	82	5	426	472.1	486.7	1 586 000	3 182 000	665
	SL183076	106 000	380	560	135	16	431.7	499.5	521.25	2 470 000	4 275 000	665
400	SL181880	19 810	400	500	46	4	432	464.5	475.5	570 000	1 197 000	665
	SL182980	54 300	400	540	82	5	450	496.3	510.85	1 643 000	3 382 000	665
	SL183080	140 000	400	600	148	18	462.5	535.1	558.52	2 945 000	5 130 000	615
420	SL181884	20 600	420	520	46	4	457	489.5	500	589 000	1 244 000	665
	SL182984	56 900	420	560	82	5	462	509	522.95	1 662 000	3 420 000	615
440	SL181888	21 540	440	540	46	4	473.5	506	517	598 000	1 311 000	615
	SL182988	78 100	440	600	95	7	490	544.6	562	2 004 000	3 942 000	570
460	SL181892	33 210	460	580	56	5	501.5	541	554	750 000	1 596 000	570
	SL182992	81 100	460	620	95	7	504	559.6	576.3	2 033 000	4 085 000	570
480	SL181896	34 530	480	600	56	5	522	561	474.5	769 000	1 653 000	570
	SL182996	94 700	480	650	100	7	538	596.6	614.75	2 289 000	4 607 000	520
500	SL1818/500	35 730	500	620	56	5	542	581.5	594.5	788 000	1 738 000	570
	SL1829/500	98 300	500	670	100	7	553	612.7	630	2 327 000	4 750 000	520

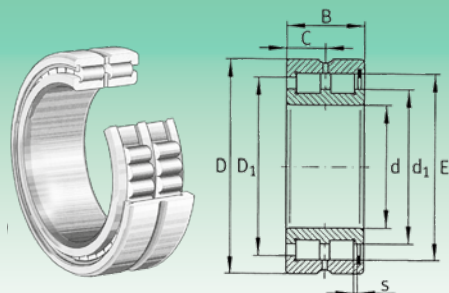

SL1850

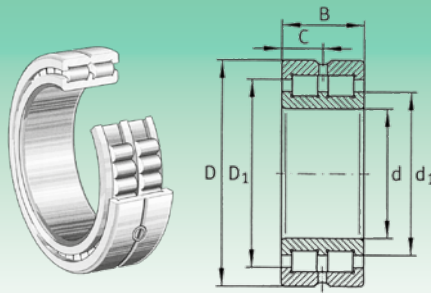

SL0148, SL0149

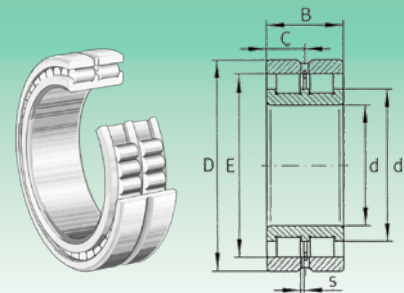

SL0248, SL0249

Diametro albero (mm) Shaft Diameter (mm)	Sigla Designation			Peso (g) Weight (g)	Dimensioni (mm) Dimensions (mm)				Dimensioni di montaggio (mm) Mounting dimensions (mm)				Coefficienti di carico (N) Basic Load Rating (N)		Velocità limite Limiting Speed
	Cuscinetto di appoggio Semi-locating bearings	Cuscinetto bloccati Locating bearings	Cuscinetto liberi Non-locating bearings		d	D	B	s	C	d ₁	D ₁	E	Dinamico C Dynamic C	Statico C ₀ Static C ₀	
20	SL185004	-	-	200	20	42	30	1	15	28.4	33.3	36.81	45 000	50 000	9 500
25	SL185005	-	-	230	25	47	30	1	15	34.5	39	42.51	51 000	61 000	8 550
30	SL185006	-	-	350	30	55	34	1.5	17	40	45.3	49.6	66 000	81 000	7 125
35	SL185007	-	-	460	35	62	36	1.5	18	44.9	51.2	55.52	80 000	103 000	6 175
40	SL185008	-	-	560	40	68	38	1.5	19	50.5	57.2	61.74	96 000	129 000	5 700
45	SL185009	-	-	710	45	75	40	1.5	20	55.3	62.6	66.85	102 000	143 000	5 225
50	SL185010	-	-	760	50	80	40	1.5	20	59.1	67.6	72.33	128 000	181 000	4 750
55	SL185011	-	-	1 160	55	90	46	1.5	23	68.5	78.7	83.54	165 000	261 000	4 275
60	-	SL014912	-	490	60	85	25	-	12.5	70.3	73.5	-	67 000	118 000	4 275
	-	-	SL024912	470	60	85	25	1	12.5	70.3	-	77.51	67 000	118 000	4 275
	SL185012	-	-	1 240	60	95	46	1.5	23	71.7	81.9	86.74	179 000	275 000	3 990
65	SL185013	-	-	1 320	65	100	46	1.5	23	78.1	88.3	93.09	189 000	304 000	3 705
70	-	SL014914	-	780	70	100	30	-	15	82.5	87.4	-	102 000	179 000	3 610
	-	-	SL024914	750	70	100	30	1	15	82.5	-	91.87	102 000	179 000	3 610
	SL185014	-	-	1 850	70	110	54	3	27	81.5	95.7	100.28	223 000	337 000	3 420
75	SL185015	-	-	1 930	75	115	54	3	27	89	102.9	107.9	235 000	370 000	3 230
80	-	SL014916	-	880	80	110	30	-	15	91.4	96.2	-	109 000	200 000	3 230
	-	-	SL024916	850	80	110	30	1	15	91.4	-	100.78	109 000	200 000	3 230
	SL185016	-	-	2 590	80	125	60	3.5	30	95	111.7	117.4	280 000	427 000	3 040
85	SL185017	-	-	2 720	85	130	60	3.5	30	99	116.1	121.95	289 000	451 000	2 850
90	-	SL014918	-	1 350	90	125	35	-	17.5	103.9	110.7	-	147 000	280 000	2 850
	-	-	SL024918	1 300	90	125	35	1.5	17.5	103	-	115.2	147 000	280 000	2 850
	SL185018	-	-	3 620	90	140	67	4	33.5	106.1	124.5	130.65	337 000	532 000	2 660
100	-	SL014920	-	1 950	100	140	40	-	20	116.4	125	-	186 000	361 000	2 565
	-	-	SL024920	1 900	100	140	40	2	20	116.4	-	129.6	186 000	361 000	2 565
	SL185020	-	-	3 940	100	150	67	4	33.5	115.7	134	140.2	356 000	589 000	2 470
110	-	SL014922	-	2 150	110	150	40	-	20	125	133.6	-	193 000	389 000	2 375
	-	-	SL024922	2 100	110	150	40	2	20	125	-	138.2	193 000	389 000	2 375
	SL185022	-	-	6 320	110	170	80	5	40	127.3	149.3	156.7	465 000	750 000	2 185
120	-	SL014924	-	2 950	120	165	45	-	22.5	138.6	148.6	-	216 000	432 000	2 185
	-	-	SL024924	2 850	120	165	45	3	22.5	138.6	-	153.55	216 000	432 000	2 185
	SL185024	-	-	6 700	120	180	80	5	40	138.8	160.7	168.15	494 000	826 000	2 090

Cuscinetti radiali a rulli cilindrici a pieno riempimento, a due corone, cuscinetti di appoggio, cuscinetti bloccati, cuscinetti liberi

Cylindrical roller bearings, full complement roller set, double row, semi-locating bearings, locating bearings, non-locating bearings

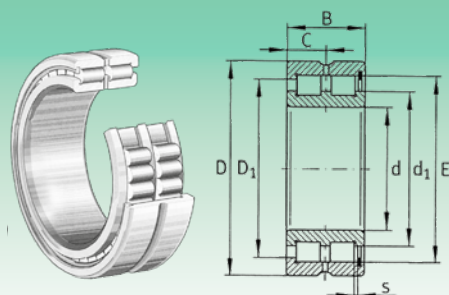

SL1850

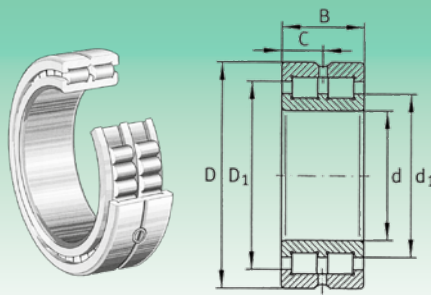

SL0148, SL0149

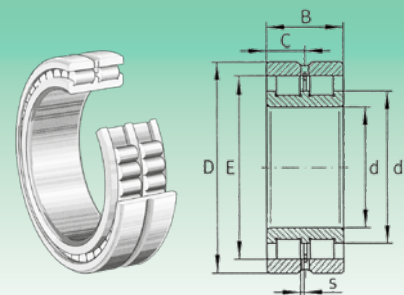

SL0248, SL0249

Diametro albero (mm) Shaft Diameter (mm)	Sigla Designation			Peso (g) Weight (g)	Dimensioni (mm) Dimensions (mm)				Dimensioni di montaggio (mm) Mounting dimensions (mm)				Coefficienti di carico (N) Basic Load Rating (N)		Velocità limite Limiting Speed
	Cuscinetto di appoggio Semi-locating bearings	Cuscinetto bloccati Locating bearings	Cuscinetto liberi Non-locating bearings		d	D	B	s	C	d ₁	D ₁	E	Dinamico C _r Dynamic C _r	Statico C ₀ Static C ₀	
130	-	SL014926	-	3 950	130	180	50	-	25	148.4	160	-	251 000	503 000	1 995
	-	-	SL024926	3 800	130	180	50	4	25	149.5	-	165.4	251 000	503 000	1 995
	SL185026	-	-	10 200	130	200	95	5	47.5	148.6	175.5	184.4	703 000	1 168 000	1 900
140	-	SL014928	-	4 200	140	190	50	-	25	159	170.5	-	261 000	541 000	1 900
	-	-	SL024928	4 100	140	190	50	4	25	160	-	175.9	261 000	541 000	1 900
	SL185028	-	-	11 100	140	210	95	5	47.5	162.6	189.5	198.4	741 000	1 292 000	1 805
150	-	SL014830	-	2 900	150	190	40	-	20	165.1	174.2	-	225 000	522 000	1 805
	-	-	SL024830	2 800	150	190	40	2	20	165.1	-	178.3	225 000	522 000	1 805
	-	-	SL014930	6 650	150	210	60	-	30	171.8	187.2	-	394 000	798 000	1 710
	-	-	SL024930	6 450	150	210	60	4	30	171.8	-	192.77	394 000	798 000	1 710
160	SL185030	-	-	13 300	150	225	100	6	50	170	198	207.45	779 000	1 349 000	1 645
	-	SL014832	-	3 100	160	200	40	-	20	173.7	182.8	-	230 000	551 000	1 710
	-	-	SL024832	3 000	160	200	40	2	20	173.7	-	186.9	230 000	551 000	1 710
	-	SL014932	-	7 000	160	220	60	-	30	184.2	200.3	-	413 000	855 000	1 615
170	-	-	SL024932	6 800	160	220	60	4	30	184.2	-	206.16	413 000	855 000	1 615
	-	SL014834	-	4 100	170	215	45	-	22.5	186.3	197	-	251 000	589 000	1 615
	-	-	SL024834	3 950	170	215	45	3	22.5	186.3	-	201.3	251 000	589 000	1 615
	-	SL014934	-	7 350	170	230	60	-	30	193.1	209.1	-	422 000	902 000	1 520
180	-	-	SL024934	7 100	170	230	60	4	30	193.1	-	215.08	422 000	902 000	1 520
	-	SL014836	-	4 300	180	225	45	-	22.5	199.1	209.8	-	261 000	627 000	1 520
	-	-	SL024836	4 150	180	225	45	3	22.5	199.1	-	214.1	261 000	627 000	1 520
	-	SL014936	-	10 800	180	250	69	-	34.5	204.9	224.1	-	551 000	1 168 000	1 425
190	-	-	SL024936	10 500	180	250	69	4	34.5	204.9	-	230.5	551 000	1 168 000	1 425
	-	SL014838	-	5 650	190	240	50	-	25	207.6	220.7	-	299 000	712 000	1 425
	-	-	SL024838	5 450	190	240	50	4	25	207.6	-	225	299 000	712 000	1 425
	-	SL014938	-	11 200	190	260	69	-	34.5	215	234.3	-	560 000	1 225 000	1 330
200	-	-	SL024938	10 900	190	260	69	4	34.5	215	-	240.7	560 000	1 225 000	1 330
	-	SL014840	-	5 900	200	250	50	-	25	218.1	231.2	-	308 000	750 000	1 330
	-	-	SL024840	5 700	200	250	50	4	25	218.1	-	235.5	308 000	750 000	1 330
	-	SL014940	-	15 800	200	280	80	-	40	230.5	252.3	-	655 000	1 406 000	1 330
-	-	SL024940	15 300	200	280	80	5	40	230.5	-	259.34	655 000	1 406 000	1 330	

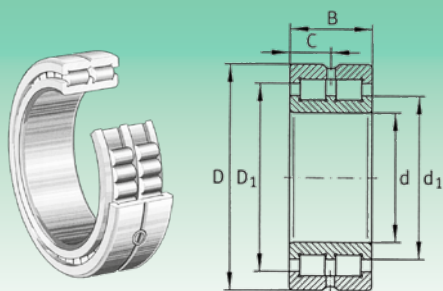

SL0148, SL0149

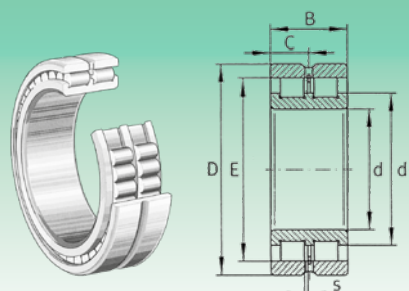

SL0248, SL0249

Diametro albero (mm) Shaft Diameter (mm)	Sigla Designation		Peso (g) Weight (g)	Dimensioni (mm) Dimensions (mm)				Dimensioni di montaggio (mm) Mounting dimensions (mm)				Coefficienti di carico (N) Basic Load Rating (N)		Velocità limite Limiting Speed
	Cuscinetto bloccati Locating bearings	Cuscinetto liberi Non-locating bearings		d	D	B	s	C	d ₁	D ₁	E	Dinamico C Dynamic C	Statico C ₀ Static C ₀	
220	SL014844	–	6 400	220	270	50	–	25	239.1	252.3	–	323 000	826 000	1 235
	–	SL024844	6 200	220	270	50	4	25	239.1	–	256.5	323 000	826 000	1 235
	SL014944	–	17 200	220	300	80	–	40	248	268.5	–	684 000	1 510 000	1 140
	–	SL024944	16 700	220	300	80	5	40	248	–	276.52	684 000	1 510 000	1 140
240	SL014848	–	10 000	240	300	60	–	30	259.5	276.7	–	494 000	1 225 000	1 140
	–	SL024848	9 900	240	300	60	4	30	259.5	–	281.9	494 000	1 225 000	1 140
	SL014948	–	18 500	240	320	80	–	40	270.6	292.3	–	712 000	1 653 000	1 140
	–	SL024948	17 900	240	320	80	5	40	270.6	–	299.46	712 000	1 653 000	1 140
260	SL014852	–	11 000	260	320	60	–	30	281.8	298.8	–	513 000	1 330 000	1 045
	–	SL024852	10 600	260	320	60	4	30	281.8	–	304.2	513 000	1 330 000	1 045
	SL014952	–	32 000	260	360	100	–	50	294.5	322.1	–	1 064 000	2 375 000	950
	–	SL024952	31 200	260	360	100	6	50	294.5	–	331.33	1 064 000	2 375 000	950
280	SL014856	–	16 000	280	350	69	–	34.5	306.8	326.4	–	674 000	1 767 000	950
	–	SL024856	15 600	280	350	69	4	34.5	306.8	–	332.4	674 000	1 767 000	950
	SL014956	–	34 000	280	380	100	–	50	316.5	344.6	–	1 111 000	2 565 000	950
	–	SL024956	33 100	280	380	100	6	50	316.5	–	353.34	1 111 000	2 565 000	950
300	SL014860	–	23 000	300	380	80	–	40	327.9	349.9	–	788 000	2 014 000	900
	–	SL024860	22 000	300	380	80	6	40	327.9	–	356.7	788 000	2 014 000	900
	SL014960	–	53 000	300	420	118	–	59	340.7	374.3	–	1 567 000	3 610 000	855
	–	SL024960	51 900	300	420	118	6	59	340.7	–	385.51	1 567 000	3 610 000	855
320	SL014864	–	24 000	320	400	80	–	40	350.9	372.9	–	817 000	2 166 000	855
	–	SL024864	23 500	320	400	80	6	40	350.9	–	379.7	817 000	2 166 000	855
	SL014964	–	56 000	320	440	118	–	59	367.5	401.1	–	1 634 000	3 895 000	805
	–	SL024964	54 900	320	440	118	6	59	367.5	–	412.27	1 634 000	3 895 000	805
340	SL014868	–	25 500	340	420	80	–	40	368.1	390.1	–	836 000	2 270 000	805
	–	SL024868	25 000	340	420	80	6	40	368.1	–	396.9	836 000	2 270 000	805
	SL014968	–	59 000	340	460	118	–	59	385.3	418.9	–	1 681 000	4 085 000	760
	–	SL024968	57 800	340	460	118	6	59	385.3	–	430.11	1 681 000	4 085 000	760

Cuscinetti radiali a rulli cilindrici a pieno riempimento, a due corone, c uscinetti di appoggio, cuscinetti bloccati, cuscinetti liberi

Cylindrical roller bearings, full complement roller set, double row, semi-locating bearings, locating bearings, non-locating bearings

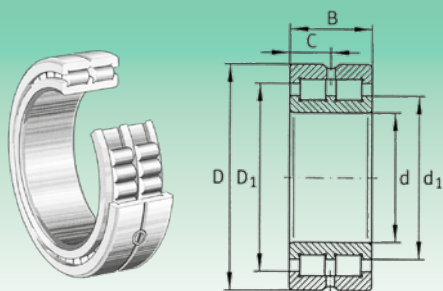

SL0148, SL0149

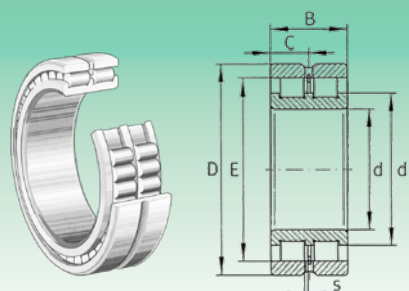

SL0248, SL0249

Diametro albero (mm) Shaft Diameter (mm)	Sigla Designation		Peso (g) Weight (g)	Dimensioni (mm) Dimensions (mm)				Dimensioni di montaggio (mm) Mounting dimensions (mm)				Coefficienti di carico (N) Basic Load Rating (N)		Velocità limite Limiting Speed
	Cuscinetto bloccati Locating bearings	Cuscinetto liberi Non-locating bearings		d	D	B	s	C	d ₁	D ₁	E	Dinamico C Dynamic C	Statico C ₀ Static C ₀	
360	SL014872	-	27 000	360	440	80	-	40	391	413.2	-	864 000	2 422 000	760
	-	SL024872	26 000	360	440	80	6	40	391	-	419.8	864 000	2 422 000	760
	SL014972	-	62 100	360	480	118	-	59	404	436.8	-	1 719 000	4 275 000	712
	-	SL024972	60 800	360	480	118	6	59	404	-	447.95	1 719 000	4 275 000	712
380	SL014876	-	45 500	380	480	100	-	50	419	447.2	-	1 263 000	3 372 000	712
	-	SL024876	44 000	380	480	100	6	50	419	-	455.8	1 263 000	3 372 000	712
	SL014976	-	92 400	380	520	140	-	70	430.2	468.7	-	2 166 000	5 320 000	665
	-	SL024976	90 500	380	520	140	7	70	430.2	-	481.35	2 166 000	5 320 000	665
400	SL014880	-	46 500	400	500	100	-	50	433.8	462	-	1 292 000	3 515 000	665
	-	SL024880	45 800	400	500	100	6	50	433.8	-	470.59	1 292 000	3 515 000	665
	SL014980	-	96 500	400	540	140	-	70	450.5	489	-	2 223 000	5 605 000	665
	-	SL024980	94 600	400	540	140	7	70	450.5	-	501.74	2 223 000	5 605 000	665

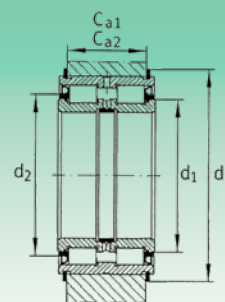
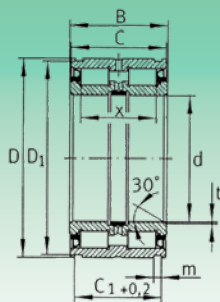
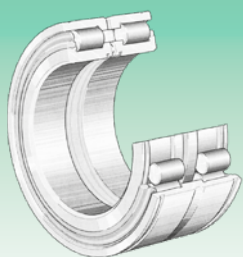

 SL0450...PP
 SL04...PP

Diametro albero (mm) Shaft Diameter (mm)	Sigla Designation	Peso (g) Weight (g)	Dimensioni (mm) Dimensions (mm)								
			d	D	B	C	C ₁	D ₁	m	t	x
20	SL045004-PP	200	20	42	30	29	24.7	40.2	1.8	0.5	22.5
25	SL045005-PP	240	25	47	30	29	24.7	45.2	1.8	0.5	22.5
30	SL045006-PP	370	30	55	34	33	28.2	53	2.1	0.5	25.5
35	SL045007-PP	480	35	62	36	35	30.2	60	2.1	0.5	27.5
40	SL045008-PP	560	40	68	38	37	32.2	65.8	2.7	0.8	28.5
45	SL045009-PP	700	45	75	40	39	34.2	72.8	2.7	0.8	30.5
50	SL045010-PP	760	50	80	40	39	34.2	77.8	2.7	0.8	30.5
55	SL045011-PP	1 180	55	90	46	45	40.2	87.4	3.2	1	36
60	SL045012-PP	1 260	60	95	46	45	40.2	92.4	3.2	1	36
65	SL045013-PP	1 330	65	100	46	45	40.2	97.4	3.2	1	36
70	SL045014-PP	1 870	70	110	54	53	48.2	107.1	4.2	1	42
75	SL045015-PP	1 960	75	115	54	53	48.2	112.1	4.2	1	42
80	SL045016-PP	2 710	80	125	60	59	54.2	122.1	4.2	1.5	48
85	SL045017-PP	2 830	85	130	60	59	54.2	127.1	4.2	1.5	48
90	SL045018-PP	3 710	90	140	67	66	59.2	137	4.2	1.5	54
95	SL045019-PP	3 880	95	145	67	66	59.2	142	4.2	1.5	54
100	SL045020-PP	3 950	100	150	67	66	59.2	147	4.2	1.5	54
110	SL045022-PP	6 570	110	170	80	79	70.2	167	4.2	1.8	64
120	SL045024-PP	7 040	120	180	80	79	71.2	176	4.2	1.8	64
130	SL045026-PP	10 500	130	200	95	94	83.2	196	4.2	1.8	77
	SL04130-PP	7 500	130	190	80	79	71.2	186	4.2	1.8	64
140	SL045028-PP	11 100	140	210	95	94	83.2	206	5.2	1.8	77
	SL04140-PP	8 000	140	200	80	79	71.2	196	4.2	1.8	64
150	SL045030-PP	13 300	150	225	100	99	87.2	221	5.2	2	80
	SL04150-PP	8 400	150	210	80	79	71.2	206	5.2	1.8	64
160	SL045032-PP	16 600	160	240	109	108	95.2	236	5.2	2	89
	SL04160-PP	8 800	160	220	80	79	71.2	216	5.2	1.8	64

Cuscinetti a rulli cilindrici con gole per anelli elastici a pieno riempimento, schermati, cuscinetti bloccati

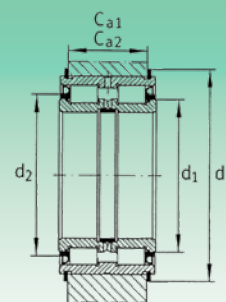
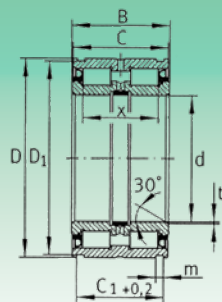
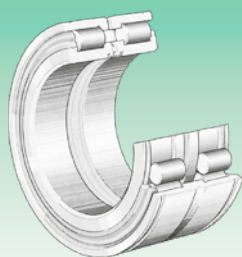

Cylindrical roller bearings with snap ring grooves full complement roller set, locating bearings

 SL0450...PP
 SL04...PP

Dimensioni di montaggio (mm) Mounting dimensions (mm)					Coefficients di carico (N) Basic Load Rating (N)		Velocità limite Limiting Speed	Anello elastico AES Elastic rings AES	Anello di ancoraggio Retaining rings
C_{a1} ¹⁾ -0,2	C_{a2} ²⁾ -0,2	d_1	d_2	d_3 ¹⁾	Dinamico C Dynamic C	Statico C_0 Static C_0			
21.5	21	30.55	34	47	40 500	49 000	4 000	AES42	42X1,75
21.5	21	35.35	39	52	44 500	58 000	3 600	AES47	47X1,75
25	24	40.6	44	60	50 000	67 000	3 000	AES55	55X2
27	26	46.1	50	67	63 000	88 000	2 600	AES62	62X2
28	27	51.4	55	75	76 000	103 000	2 400	AES68	68X2,5
30	29	57	61	82	92 000	130 000	2 200	AES75	75X2,5
30	29	61.8	66	87	97 000	142 000	2 000	AES80	80X2,5
35	34	68.6	73	99	115 000	175 000	1 800	AES90	90X3
35	34	73.7	79	104	120 000	189 000	1 700	AES95	95X3
35	34	78.8	84	109	125 000	203 000	1 600	AES100	100X3
43	40	84.5	91	119	168 000	265 000	1 400	AES110	110X4
43	40	89.95	97	124	194 000	300 000	1 400	AES115	115X4
49	46	97.1	105	137	203 000	325 000	1 300	AES125	125X4
49	46	103.9	112	142	211 000	350 000	1 200	AES130	130X4
54	51	109.3	118	152	305 000	510 000	1 100	AES140	140X4
54	51	113.35	122	157	315 000	530 000	1 100	AES145	145X4
54	51	117.35	128	162	330 000	550 000	1 000	AES150	150X4
65	62	131.55	143	182	395 000	680 000	900	AES170	170X4
65	63	140.9	153	196	410 000	740 000	900	AES180	180X4
77	75	156.75	170	216	540 000	960 000	800	AES200	200X4
65	63	150.55	160	206	430 000	790 000	800	AES190	190X4
77	73	165.4	181	226	610 000	1 100 000	750	AES210	210X5
65	63	159.95	170	216	445 000	840 000	750	AES200	200X4
81	77	175.7	192	245	710 000	1 260 000	700	AES225	225X5
65	61	174.4	185	226	465 000	920 000	700	AES210	210X5
89	85	189	207	260	740 000	1 360 000	650	AES240	240X5
65	61	184.05	196	236	480 000	970 000	700	AES220	220X5

¹⁾ Per anelli elastici AES - For AES elastic rings

²⁾ Per anelli di ancoraggio - For retaining rings

³⁾ Montaggio obbligatorio con anelli AES (vedi pag. 194 e indice) - Obligatory assembly with AES rings (pag. 194 and index)



Cuscinetti a rulli cilindrici con gole per anelli elastici a pieno riempimento, schermati, cuscinetti bloccati

Cylindrical roller bearings with snap ring grooves full complement roller set, locating bearings

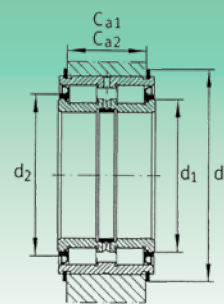
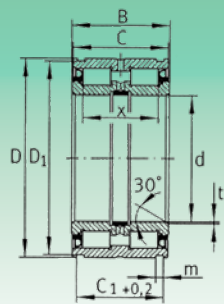
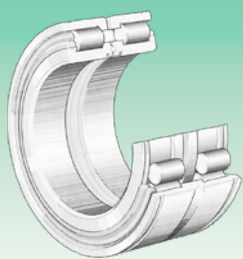

SL0450..-PP
SL04..-PP

Diametro albero (mm) Shaft Diameter (mm)	Sigla Designation	Peso (g) Weight (g)	Dimensioni (mm) Dimensions (mm)								
			d	D	B	C	C ₁	D ₁	m	t	x
170	SL045034-PP	22 600	170	260	122	121	107.2	254	5.2	2	100
	SL04170-PP	9 300	170	230	80	79	71.2	226	5.2	1.8	64
180	SL045036-PP	30 100	180	280	136	135	118.2	274	5.2	2	112
	SL04180-PP	9 800	180	240	80	79	71.2	236	5.2	1.8	64
190	SL045038-PP	31 500	190	290	136	135	118.2	284	5.2	2	112
	SL04190-PP	12 700	190	260	80	79	73.2	254	5.2	1.8	64
200	SL045040-PP	40 800	200	310	150	149	128.2	304	6.3	2	126
	SL04200-PP	13 200	200	270	80	79	73.2	264	5.2	1.8	64
220	SL045044-PP	52 500	220	340	160	159	138.2	334	6.3	2	132
	SL04220-PP	19 500	220	300	95	94	83.2	294	5.2	2	72
240	SL045048-PP	56 000	240	360	160	159	138.2	354	6.3	2	132
	SL04240-PP	21 000	240	320	95	94	83.2	314	6.3	2	72
260	SL045052-PP	84 500	260	400	190	189	162.2	394	6.3	3	150
	SL04260-PP	22 500	260	340	95	94	83.2	334	6.3	3	75
280	SL045056-PP	90 000	280	420	190	189	163.2	413	7.3	3	150
300	SL045060-PP	126 000	300	460	218	216	185.2	453	7.3	3	170
	SL04300-PP	25 500	300	380	95	94	83.2	374	6.3	3	75



Cuscinetti a rulli cilindrici con gole per anelli elastici a pieno riempimento, schermati, cuscinetti bloccati



Cylindrical roller bearings with snap ring grooves full complement roller set, locating bearings

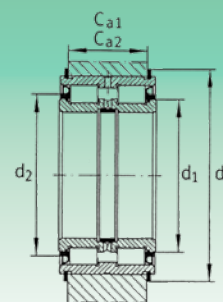
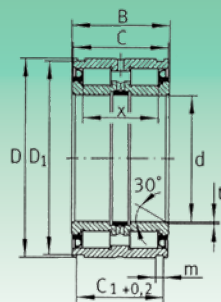
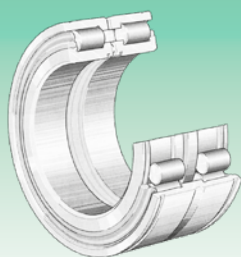

 SL0450..-PP
 SL04..-PP

Dimensioni di montaggio (mm) Mounting dimensions (mm)					Coefficienti di carico (N) Basic Load Rating (N)		Velocità limite Limiting Speed	Anello elastico AES Elastic rings AES	Anello di ancoraggio Retaining rings
C_{a1} ¹⁾ -0.2	C_{a2} ²⁾ -0.2	d_1	d_2	d_3 ¹⁾	Dinamico C Dynamic C	Statico C_0 Static C_0			
99	97	200.7	220	282	960 000	1 750 000	600	AES260	260X5
65	61	193.9	206	250	490 000	1 030 000	650	AES230	230X5
110	108	217.8	239	302	1 140 000	2 130 000	550	AES280	280X5
65	61	203.1	216	260	500 000	1 080 000	600	AES240	240X5
110	108	225.65	248	312	1 160 000	2 210 000	550	AES290	290X5
65	63	217.55	231	282	520 000	1 130 000	550	AES260	260X5
120	116	243.05	267	336	1 350 000	2 600 000	500	AES310	310X6
65	63	227.15	241	292	540 000	1 210 000	550	AES270	270X5
130	126	259.85	286	366	1 570 000	3 050 000	480	AES340	340X6
75	73	248.7	264	322	700 000	1 550 000	480	AES300	300X5
130	126	279.25	305	386	1 630 000	3 300 000	440	AES360	360X6
75	71	271.7	287	346	740 000	1 700 000	480	AES320	320X6
154	150	304.95	336	426	2 380 000	4 700 000	400	AES400	400X6
75	71	292.7	310	366	840 000	1 990 000	440	AES340	340X6
154	149	320.95	354	453	2 600 000	5 200 000	380	AES420	420X7
176	171	346.85	375	493	3 000 000	5 800 000	340	AES460	460X7
75	71	328	346	406	900 000	2 250 000	380	AES380	380X6

¹⁾ Per anelli elastici AES - For AES elastic rings

²⁾ Per anelli di ancoraggio - For retaining rings

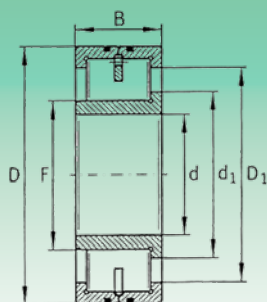
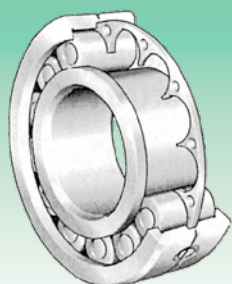
³⁾ Montaggio obbligatorio con anelli AES (vedi pag. 194 e indice) - Obligatory assembly with AES ring (pag. 194 and index)

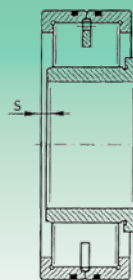

LSL 1923

¹⁾ Spostamento assiale «s»
¹⁾ Axial displacement distance «s»

Sigla Designation	Peso (g) Weight (g)	Dimensioni (mm) Dimensions (mm)				Dimensioni di montaggio (mm) Mounting dimensions (mm)			Coefficienti di carico (N) Basic load rating (N)		Velocità limite Limiting speed
		d	D	B	s ¹⁾	F	d ₁	D ₁	Dinamico C Dynamic C	Statico C ₀ Static C ₀	
LSL192316	6 100	80	170	58	3.5	94.00	104.50	134.80	475 000	495 000	8 800
LSL192317	7 300	85	180	60	4	100.00	111.30	143.90	500 000	520 000	8 300
LSL192318	8 600	90	190	64	4	105.26	117.20	152.50	590 000	610 000	7 900
LSL192319	10 000	95	200	67	4	114.66	126.60	161.00	610 000	660 000	7 500
LSL192320	12 800	100	215	73	4	119.30	132.70	172.00	636 500	760 000	6 175
LSL192322	17 300	110	240	80	5	135.50	150.70	193.10	750 500	893 000	5 320
LSL192324	22 000	120	260	86	5	147.39	164.20	213.10	902 500	1 092 500	5 035
LSL192326	27 200	130	280	93	5	157.90	176.00	227.90	1 016 500	1 235 000	4 655
LSL192328	34 000	140	300	102	7	168.45	187.50	243.20	1 140 000	1 396 500	4 370
LSL192330	40 700	150	320	108	7	182.49	203.30	263.90	1 349 000	1 691 000	3 990
LSL192332	48 100	160	340	114	7	196.38	219.00	284.80	1 520 000	1 919 000	3 700
LSL192334	57 500	170	360	120	7	230.55	226.60	295.40	1 662 500	2 118 500	3 600
LSL192336	67 400	180	380	126	7	221.56	245.00	313.30	1 757 500	2 318 000	3 325
LSL192338	78 100	190	400	132	7	224.43	250.00	325.50	2 004 500	2 612 500	3 230
LSL192340	89 300	200	420	138	7	238.45	265.70	345.90	2 232 500	2 897 500	3 040
LSL192344	108 000	220	460	145	7	266.71	297.00	385.90	2 375 000	3 040 000	2 750
LSL192348	138 600	240	500	155	10	280.55	312.50	406.10	2 612 500	3 372 500	2 565
LSL192352	168 000	260	540	165	10	315.60	351.60	457.20	3 230 000	4 180 000	2 280
LSL192356	206 600	280	580	175	12	333.10	371.00	485.00	3 515 000	4 607 500	2 185
LSL192360	253 000	300	620	185	12	350.93	390.90	508.50	3 942 500	5 320 000	2 090

²⁾ Gabbia a disco in ottone.
 Machined brass disc cage

Cuscinetti radiali a rulli cilindrici con distanziali ²⁾, cuscinetti di appoggio
Cylindrical roller bearings with spacers ²⁾, semi-locating bearings

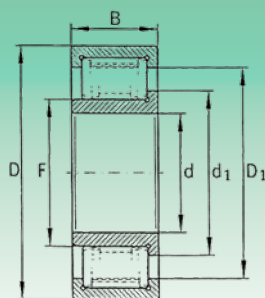
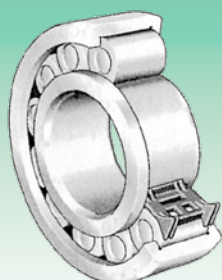

ZSL 1923

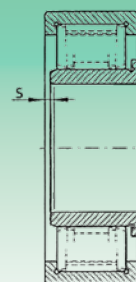
¹⁾ Spostamento assiale «s»
¹⁾ Axial displacement distance «s»

Sigla Designation	Peso (g) Weight (g)	Dimensioni (mm) Dimensions (mm)				Dimensioni di montaggio (mm) Mounting dimensions (mm)			Coefficienti di carico (N) Basic load rating (N)		Velocità limite Limiting speed
		d	D	B	s ¹⁾	F	d ₁	D ₁	Dinamico C Dynamic C	Statico C ₀ Static C ₀	
ZSL192305	360	25	62	24	2	31.72	36.70	47.50	57 950	52 250	15 200
ZSL192306	550	30	72	27	2	38.30	43.50	56.00	79 800	76 950	13 300
ZSL192307	720	35	80	31	2	44.68	50.70	65.80	100 700	98 800	11 400
ZSL192308	1 000	40	90	33	2	51.12	57.50	75.20	135 850	136 800	10 450
ZSL192309	1 340	45	100	36	3	56.10	62.50	80.30	145 350	152 000	9 500
ZSL192310	1 760	50	110	40	3	60.72	68.30	89.70	186 200	191 900	8 550
ZSL192311	2 220	55	120	43	3	67.11	75.50	99.30	216 600	224 200	7 600
ZSL192312	2 820	60	130	46	3	73.62	82.00	105.8	231 800	247 000	7 000
ZSL192313	3 440	65	140	48	3.5	80.69	90.00	116.50	385 000	313 500	6 450
ZSL192314	4 270	70	150	51	3.5	84.14	93.50	121.60	313 500	346 750	6 080
ZSL192315	5 200	75	160	55	3.5	91.22	101.60	131.90	370 500	418 000	5 700
ZSL192316	6 200	80	170	58	3.5	98.24	109.50	142.10	432 250	494 000	5 320
ZSL192317	7 230	85	180	60	4	107.01	118.20	150.90	460 750	541 500	5 050
ZSL192318	8 700	90	190	64	4	105.26	117.50	152.50	503 500	579 500	4 750
ZSL192319	10 000	95	200	67	4	114.65	126.60	161.90	532 000	636 500	4 550
ZSL192320	12 700	100	215	73	4	119.30	132.70	172.80	636 500	760 000	4 180
ZSL192322	16 500	110	240	80	5	134.27	151.10	199.90	760 000	864 500	3 800
ZSL192324	21 900	120	260	86	5	147.39	164.20	213.10	902 500	1 092 500	3 500

²⁾ Distanziali in plastica, temperatura d'esercizio ammissibile a +120°C (funzionamento continuo).
 Plastic spacers, permissible operating temperature +120°C (continuous operation)





PATTINI A RULLI

RECIRCULATING LINEAR ROLLER BEARINGS

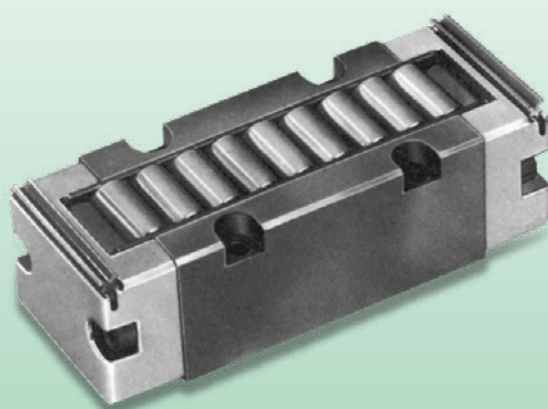





I pattini a circolazione di rulli accostati ISB vengono solitamente impiegati per supportare dei sistemi con movimento lineare permettendo, grazie all'accostamento, applicazioni praticamente illimitate.

Questo tipo particolare di corpo volvente trova la sua migliore applicazione in macchine dove vi è la necessità di ottenere un'alta precisione e carichi elevati.

I pattini sono principalmente costituiti da una guida in acciaio temprato, lavorato ad alta precisione ed a forma di H che garantisce la massima rigidità e dai rulli che sono i corpi volventi.

Le piste di rotolamento al fine di ottenere le prestazioni più elevate possibili devono avere una durezza compresa tra i 58 HRC ed i 64 HRC. Occorre puntualizzare che la precisione viene ottenuta soprattutto in virtù dell'allineamento delle guide, perché se vengono perfettamente allineate e tutte costruite con la stessa lunghezza si possono raggiungere ottimi risultati sia per ciò che riguarda la precisione di scorrimento che la silenziosità. Grazie all'uniformità d'attrito che risulta molto bassa, i pattini a circolazione di rulli accostati garantiscono il non manifestarsi dell'effetto "stick slip", cosa che avviene più comunemente nelle guide a strisciamento. La lubrificazione può essere eseguita sia con grasso che con olio, (vale lo stesso concetto dei cuscinetti a rullini). La lubrificazione ad olio permette di raggiungere velocità superiori di traslazione. Si consiglia di muovere i pattini durante la lubrificazione, per consentire al lubrificante di penetrare in tutte le parti. Possono essere forniti anche dei raschiatori elastici da applicare sui pattini che sono composti da un doppio labbro che funge da protezione per eventuali agenti esterni impuri e da trattenimento per il lubrificante presente.

ISB runners are usually employed to stand linear movement systems and thanks to their approach, their applications are unlimited.

Their best application is in tools and textile machinery, where a great precision must be obtained and very high loads must be stood.

Runners consist in an hardened steel guidance with an "H" form, and in rollers that are the bearings, the steel guidance is used as rolling groove.

The steel is worked with very high precision and has an "H" shape; this form guarantees maximum rigidity.

The raceways, to obtain highest performances, must have an hardness included within 58 HRC and 64 HRC.

Concerning precision, this is determined by guides alignment: if all guidances are perfectly aligned and have the same length, very good results concerning sliding precision and silentness can be reached.

Thanks to the friction uniformity which is very low, the runners guarantee against "stick lip" effect.

Runners can be lubricated either with grease or oil, rules are the same as for needle roller bearings; an oil lubrication enables to reach higher speed rotations and it is also important to remember what type of lubricant has been used at the beginning.

We recommend to move the runners during lubrication: in this way lubricant is able to penetrate in every part.

Elastic scrapers for runners can be supplied, basically formed by a double lip, that protects from external factors and holds the lubricant.



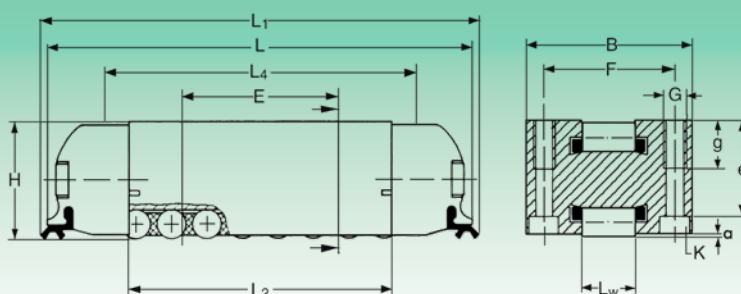
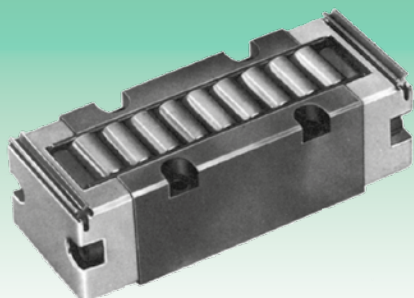

Sigla Designation	Peso (g) Weight (g)	Dimensioni (mm) Dimensions (mm)														Coefficienti di carico (N) Basic Load Rating (N)	
		H	L	B	$L_1 \approx$	L_2	L_3	L_w	a	L_4	E $\pm 0,1$	F $\pm 0,1$	G	e	g	Dinamico C Dynamic C	Statico C_0 Static C_0
PAR 19069	160	19	69	27	75	44	-	10	0.2	50	25.5	20.6	M 4	15.5	6	42 000	33 000
PAR 19105	270	19	105	27	111	78.5	-	10	0.2	85	50	20.6	M 4	15.5	6	68 000	61 000
PAR 26086	410	26	86	40	92	53	-	14	0.2	63	28	30	M 6	21	10	76 000	56 000
PAR 26102	530	26	102	40	108	69	-	14	0.2	79	44	30	M 6	21	10	95 000	75 000
PAR 26126	700	26	126	40	132	93	-	14	0.2	103	68	30	M 6	21	10	122 000	103 000
PAR 38134	1 270	38	133	52	133	85	-	20	0.2	100	51	41	M 8	31	14	179 000	133 000
PAR 38206	2 280	38	206	52	206	158	-	20	0.2	172	102	41	M 8	31	14	305 000	265 000
PAR 65210	7 500	65	211	76	234	134	-	30	0.5	-	76	62	M 10	55	22	465 000	345 000
PAR 85280	16 000	85	281	104	303	185	-	40	0.5	-	101.5	82.5	M 14	73	30	840 000	620 000

Prodotto disponibile su richiesta

Available only under request



RULLINI

NEEDLE ROLLERS

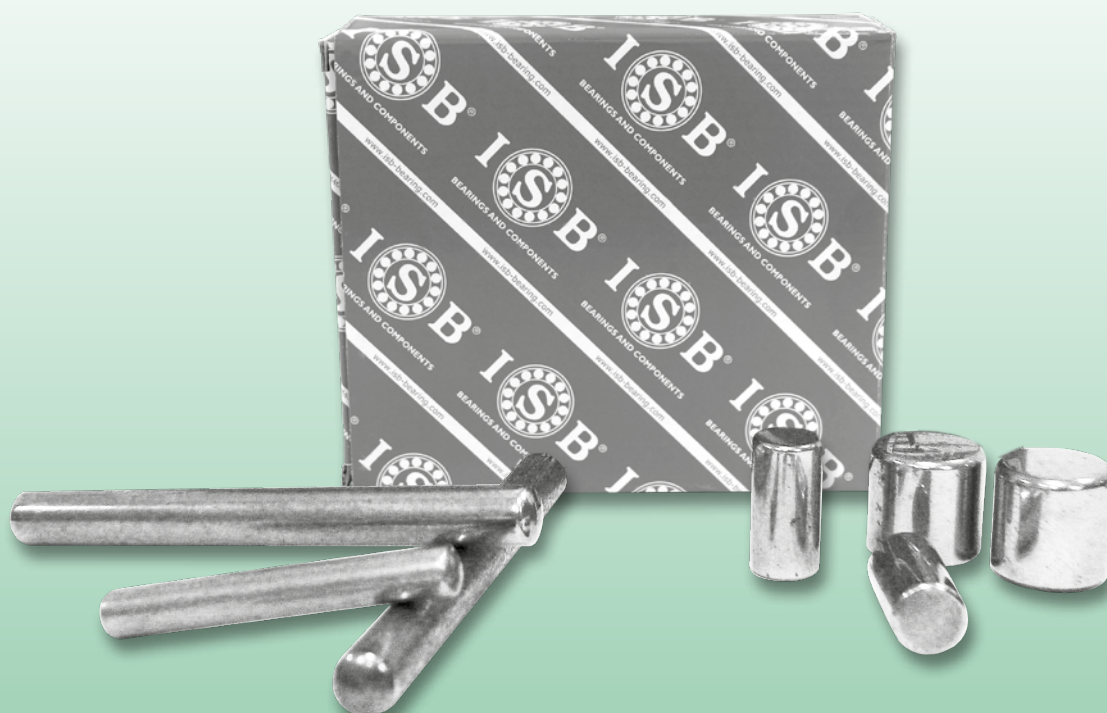





I rullini ISB consentono la realizzazione di cuscinetti a pieno riempimento che, con il minimo ingombro possibile, possono sopportare carichi elevati.

Disponendo i rullini direttamente tra l'albero e la sede senza alcun anello interno od esterno, l'albero può essere dimensionato con il massimo diametro possibile, ottenendo il miglior risultato per quanto riguarda rigidità e capacità di carico. Nel caso che vi siano applicazioni che necessitano di rullini particolarmente lunghi rispetto al diametro dell'albero, è opportuno l'utilizzo di corone con doppia fila di rullini di uguale lunghezza, separate da un distanziale.

Per ottenere la capacità massima di carico occorre che le piste di rotolamento abbiano in superficie una durezza compresa tra i 58 HRC ed i 64 HRC.

I rullini sono realizzati in acciaio da cuscinetti temprato a cuore ed anche loro hanno una durezza compresa tra i valori sopraindicati, su richiesta specifica possono essere forniti in acciaio inossidabile temprato.

La rugosità superficiale dei rullini è inferiore a 0,2 µm.

ISB needle rollers allow the realisation of full complement bearings that, with minimum dimensions, are able to stand heavy loads.

By putting directly the needle rollers within the shaft and the housing without any outer or inner ring, the shaft can be measured with the maximum allowed diameter, obtaining in this way best result for loading ability and rigidity.

In case of applications requiring very long needle rollers respect to shaft diameter, it is better to use crowns with double row needle rollers of the same length, separate from a spacer.

To obtain highest load ability, raceways must have an hardness between 58 HRC and 64 HRC on their surfaces.

Needle rollers are made of steel used for bearings which is heart tempered and have the same hardness as above, under request they can be made of stainless hardened steel.

Their surface roughness is lower than 0.2 µm.

Scostamento e tolleranze per diametro Dw¹⁾ - Deviation and tolerances for diameter Dw¹⁾

Classe di precisione Precision class	Scostamenti Deviations µm	Tolleranza di una selezionatura Tolerance of selection µm	Selezionature ²⁾ Selections µm			Rotondità ¹⁾ Roundness ¹⁾ (DIN ISO) µm	Rugosità Roughness R _a µm	Concavità Concavity µm	Tolleranze sulla lunghezza Length tolerances
G 2	0-10	2	0-2	-1 -3	-2 - 4	1.0	0,1	0,5	h13
-	0-10	5	-3-5	-4 -6	-5 - 7	-	-	-	-
-	-	-	-6-8	-7 -9	-8 -10	-	-	-	-
G 5	0-10	5	0-5	-3 -8	-5 -10	2.5	0,25	1,0	h13

¹⁾ Il diametro e la rotondità devono essere rilevati al centro del rullino.
Diameter and roundness must be measured on needle roller center.

²⁾ Campo di selezionatura preferenziale indicata in grassetto.
Preferential field of selections, indicated in boldface.

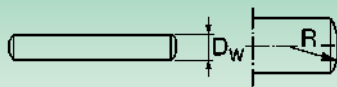
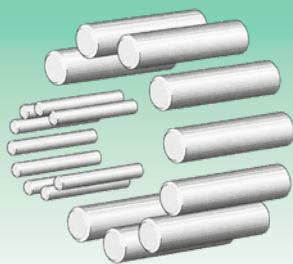
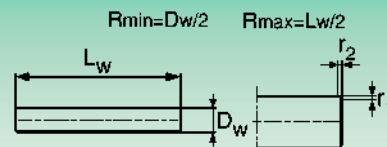

 Forma A - Applicazioni speciali
A form - Special applications

 Forma B - Applicazioni generiche
B form - Generic applications

Sigla Designation	Peso per 1000 pz. (kg) Weight for 1000 Pcs (kg)	Dimensioni (mm) Dimensions (mm)					
		D _w	L _w	r ₁ min.	r ₂ ¹⁾ min.	r ₁ min.	r ₂ ¹⁾ min.
NR 1 x 5,8	0.034	1	5.8	0.1	0.4	0.1	0.6
NR 1 x 6,8	0.042	1	6.8	0.1	0.4	0.1	0.6
NR 1 x 7,8	0.047	1	7.8	0.1	0.4	0.1	0.6
NR 1 x 9,8	0.059	1	9.8	0.1	0.4	0.1	0.6
NR 1,5 x 5,8	0.080	1.5	5.8	0.1	0.4	0.1	0.6
NR 1,5 x 6,8	0.094	1.5	6.8	0.1	0.4	0.1	0.6
NR 1,5 x 7,8	0.108	1.5	7.8	0.1	0.4	0.1	0.6
NR 1,5 x 9,8	0.136	1.5	9.8	0.1	0.4	0.1	0.6
NR 1,5 x 11,8	0.164	1.5	11.8	0.1	0.4	0.1	0.6
NR 1,5 x 13,8	0.191	1.5	13.8	0.1	0.4	0.1	0.6
NR 2 x 6,3	0.140	2	6.3	0.2	0.6	0.2	0.8
NR 2 x 7,8	0.190	2	7.8	0.2	0.6	0.2	0.8
NR 2 x 9,8	0.240	2	9.8	0.2	0.6	0.2	0.8
NR 2 x 11,8	0.290	2	11.8	0.2	0.6	0.2	0.8
NR 2 x 13,8	0.340	2	13.8	0.2	0.6	0.2	0.8
NR 2 x 15,8	0.390	2	15.8	0.2	0.6	0.2	0.8
NR 2 x 17,8	0.440	2	17.8	0.2	0.6	0.2	0.8
NR 2 x 19,8	0.490	2	19.8	0.2	0.6	0.2	0.8
NR 2 x 21,8	0.540	2	21.8	0.2	0.6	0.2	0.8
NR 2,5 x 7,8	0.300	2.5	7.8	0.2	0.6	0.2	0.8
NR 2,5 x 9,8	0.380	2.5	9.8	0.2	0.6	0.2	0.8
NR 2,5 x 11,8	0.450	2.5	11.8	0.2	0.6	0.2	0.8
NR 2,5 x 13,8	0.530	2.5	13.8	0.2	0.6	0.2	0.8
NR 2,5 x 15,8	0.610	2.5	15.8	0.2	0.6	0.2	0.8
NR 2,5 x 17,8	0.690	2.5	17.8	0.2	0.6	0.2	0.8
NR 2,5 x 19,8	0.760	2.5	19.8	0.2	0.6	0.2	0.8
NR 2,5 x 21,8	0.840	2.5	21.8	0.2	0.6	0.2	0.8
NR 2,5 x 23,8	0.920	2.5	23.8	0.2	0.6	0.2	0.8
NR 3 x 9,8	0.540	3	9.8	0.2	0.6	0.2	0.8
NR 3 x 11,8	0.650	3	11.8	0.2	0.6	0.2	0.8
NR 3 x 13,8	0.760	3	13.8	0.2	0.6	0.2	0.8
NR 3 x 15,8	0.870	3	15.8	0.2	0.6	0.2	0.8
NR 3 x 17,8	0.990	3	17.8	0.2	0.6	0.2	0.8
NR 3 x 19,8	1.10	3	19.8	0.2	0.6	0.2	0.8
NR 3 x 21,8	1.21	3	21.8	0.2	0.6	0.2	0.8
NR 3 x 23,8	1.32	3	23.8	0.2	0.6	0.2	0.8
NR 3 x 25,8	1.43	3	25.8	0.2	0.6	0.2	0.8
NR 3 x 27,8	1.54	3	27.8	0.2	0.6	0.2	0.8
NR 3 x 29,8	1.61	3	29.8	0.2	0.6	0.2	0.8

Sigla Designation	Peso per 1000 pz. (kg) Weight for 1000 Pcs (kg)	Dimensioni (mm) Dimensions (mm)					
		D _w	L _w	r ₁ min.	r ₂ ¹⁾ min.	r ₁ min.	r ₂ ¹⁾ min.
NR 3,5 x 11,8	0.91	3.5	11.8	0.3	0.8	0.3	1.0
NR 3,5 x 13,8	1.05	3.5	13.8	0.3	0.8	0.3	1.0
NR 3,5 x 15,8	1.19	3.5	15.8	0.3	0.8	0.3	1.0
NR 3,5 x 17,8	1.35	3.5	17.8	0.3	0.8	0.3	1.0
NR 3,5 x 19,8	1.51	3.5	19.8	0.3	0.8	0.3	1.0
NR 3,5 x 21,8	1.67	3.5	21.8	0.3	0.8	0.3	1.0
NR 3,5 x 23,8	1.85	3.5	23.8	0.3	0.8	0.3	1.0
NR 3,5 x 25,8	1.96	3.5	25.8	0.3	0.8	0.3	1.0
NR 3,5 x 27,8	2.10	3.5	27.8	0.3	0.8	0.3	1.0
NR 3,5 x 29,8	2.25	3.5	29.8	0.3	0.8	0.3	1.0
NR 3,5 x 34,8	2.65	3.5	34.8	0.3	0.8	0.3	1.0
NR 4 x 11,8	1.16	4	11.8	0.3	0.8	0.3	1.0
NR 4 x 13,8	1.36	4	13.8	0.3	0.8	0.3	1.0
NR 4 x 15,8	1.55	4	15.8	0.3	0.8	0.3	1.0
NR 4 x 17,8	1.75	4	17.8	0.3	0.8	0.3	1.0
NR 4 x 19,8	1.95	4	19.8	0.3	0.8	0.3	1.0
NR 4 x 21,8	2.14	4	21.8	0.3	0.8	0.3	1.0
NR 4 x 23,8	2.33	4	23.8	0.3	0.8	0.3	1.0
NR 4 x 25,8	2.53	4	25.8	0.3	0.8	0.3	1.0
NR 4 x 27,8	2.62	4	27.8	0.3	0.8	0.3	1.0
NR 4 x 29,8	2.95	4	29.8	0.3	0.8	0.3	1.0
NR 4 x 34,8	3.40	4	34.8	0.3	0.8	0.3	1.0
NR 4 x 39,8	3.90	4	39.8	0.3	0.8	0.3	1.0
NR 5 x 15,8	2.43	5	15.8	0.3	0.8	0.3	1.0
NR 5 x 19,8	3.03	5	19.8	0.3	0.8	0.3	1.0
NR 5 x 21,8	3.36	5	21.8	0.3	0.8	0.3	1.0
NR 5 x 23,8	3.58	5	23.8	0.3	0.8	0.3	1.0
NR 5 x 25,8	3.98	5	25.8	0.3	0.8	0.3	1.0
NR 5 x 27,8	4.18	5	27.8	0.3	0.8	0.3	1.0
NR 5 x 29,8	4.60	5	29.8	0.3	0.8	0.3	1.0
NR 5 x 34,8	5.40	5	34.8	0.3	0.8	0.3	1.0
NR 5 x 39,8	6.15	5	39.8	0.3	0.8	0.3	1.0
NR 5 x 49,8	7.50	5	49.8	0.3	0.8	0.3	1.0
NR 6 x 17,8	3.95	6	17.8	0.3	0.8	0.3	1.0
NR 6 x 21,8	4.83	6	21.8	0.3	0.8	0.3	1.0
NR 6 x 23,8	5.28	6	23.8	0.3	0.8	0.3	1.0
NR 6 x 25,8	5.72	6	25.8	0.3	0.8	0.3	1.0
NR 6 x 39,8	8.83	6	39.8	0.3	0.8	0.3	1.0

 1) Valori medi
 1) Medium values



ANELLI DI TENUTA PER BUSSOLE DI SCORRIMENTO (SERIE VB - VCW - VC)

SEALS FOR SLIDING BALL BUSHING (VB - VCW - VC SERIES)





**Anelli di tenuta per bussole di scorrimento (serie VB)****Seals for sliding ball bushing (VB series)**

Gli anelli di tenuta per movimenti assiali sono costituiti da inserto metallico in acciaio, da un rivestimento in elastomero e da un labbro di tenuta senza molla con speciale interferenza, che garantisce un bassissimo assorbimento di potenza. L'anello di tenuta deve avere il labbro rivolto verso il fluido da tenere, oppure verso l'esterno, se deve effettuare la tenuta di infiltrazioni provenienti dall'ambiente esterno.

Specifiche tecniche:

- Materiali: NBR -40 ÷ + 120°C
FKM -30 ÷ +200°C
- Velocità di esercizio: 8 m/s
- Pressione d'esercizio: 0 kg/cm²

These seals suitable for axial movements applications, consist of a metal case with rubber covered and a single thin lip, without spring that, together with minimal interference, has very low frictional loss.

Seals can be fitted with the lip in front of the fluid to be sealed or toward the outside to protect from dust and dirt.

Technical data:

- Compounds: NBR -40 ÷ + 120°C
FKM -30 ÷ +200°C
- Speed limit: 8 m/s
- Pressure: 0 kg/cm²

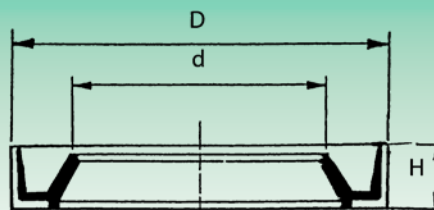

VB - Armatura esterna in metallo
 Metal outer diameter

Tipo Type	Dimensioni Dimensions (mm)		
	Diametro Diameter		H
	d	D	

Tipo Type	Dimensioni Dimensions (mm)		
	Diametro Diameter		H
	d	D	

Tipo Type	Dimensioni Dimensions (mm)		
	Diametro Diameter		H
	d	D	

Tipo Type	Dimensioni Dimensions (mm)		
	Diametro Diameter		H
	d	D	

VB	4.00	8.00	2.00
VB	4.80	12.70	3.20
VB	5.00	9.00	2.00
VB	5.00	10.00	2.00
VB	6.00	10.00	2.00
VB	6.00	12.00	2.00
VB	6.40	15.88	4.00
VB	7.00	11.00	2.00
VB	7.00	14.00	2.00
VB	7.90	12.70	2.50
VB	7.90	15.88	3.80
VB	8.00	12.00	3.00
VB	8.00	14.00	4.00
VB	9.00	12.65	3.00
VB	9.00	13.00	3.00
VB	9.50	14.29	2.40
VB	9.50	16.51	2.70
VB	9.50	19.05	6.40
VB	9.50	22.23	6.40
VB	9.50	23.81	4.80
VB	9.53	15.88	3.20
VB	10.00	14.00	3.00
VB	10.00	15.00	3.00
VB	10.00	16.00	4.00
VB	10.00	17.00	3.00
VB	10.20	26/34	4.50
VB	11.00	15.00	3.00
VB	11.00	17.00	3.00

VB	11.10	15.88	3.20
VB	11.10	16.50	2.50
VB	11.10	17.46	3.20
VB	11.10	21.23	4.80
VB	11.50	22.23	4.80
VB	11.90	18.24	3.20
VB	11.91	17.86	3.20
VB	11.91	22.23	5.60
VB	12.00	16.00	3.00
VB	12.00	18.00	3.00
VB	12.00	18.00	5.00
VB	12.00	19.00	3.00
VB	12.00	20.00	5.00
VB	12.70	19.05	3.20
VB	12.70	19.75	5.00
VB	12.70	22.23	5.60
VB	12.70	22.23	6.40
VB	13.00	20.00	5.00
VB	13.00	32.00	10.50
VB	13.49	22.23	3.20
VB	14.00	18.00	3.20
VB	14.00	20.00	3.00
VB	14.00	22.00	3.00
VB	14.00	22.00	4.00
VB	14.29	22.23	4.80
VB	14.50	32.00	10.60
VB	15.00	21.00	3.00
VB	15.00	22.00	4.00

VB	15.00	32.00	6.00
VB	15.88	20.64	2.40
VB	15.88	22.23	3.20
VB	15.88	23.81	4.40
VB	15.88	25.40	3.20
VB	15.88	25.40	6.40
VB	15.88	26.99	4.80
VB	16.00	22.00	3.00
VB	16.00	24.00	3.00
VB	16.00	24.00	4.00
VB	16.00	30.00	4.50
VB	16.50	21.45	3.00
VB	17.00	20.80	3.20
VB	17.00	21.50	3.00
VB	17.00	23.00	3.00
VB	17.46	25.37	4.80
VB	17.46	28.55	6.40
VB	17.78	23.81	4.80
VB	18.00	26.00	4.00
VB	18.30	38.10	6.40
VB	18.50	32.00	10.60
VB	19.00	27.00	4.00
VB	19.05	25.37	3.20
VB	19.05	25.40	3.20
VB	19.05	25.40	3.20
VB	19.05	26.47	4.10
VB	19.05	28.55	4.00
VB	19.05	28.58	4.40

VB	19.05	30.16	4.00
VB	19.05	38.07	6.40
VB	19.84	27.10	4.60
VB	19.84	31.75	3.20
VB	20.00	26.00	4.00
VB	20.00	28.00	4.00
VB	22.00	28.00	4.00
VB	22.00	30.00	4.00
VB	22.00	32.00	3.00
VB	22.23	28.58	3.20
VB	22.23	28.58	6.40
VB	22.23	30.16	4.00
VB	22.23	30.16	4.80
VB	22.23	33.22	6.40
VB	22.23	34.93	6.40
VB	22.23	36.51	6.40
VB	22.86	38.10	6.40
VB	24.60	31.75	3.20
VB	25.00	32.00	4.00
VB	25.00	32.00	5.00
VB	25.00	34.00	5.00
VB	25.00	35.00	4.00
VB	25.00	35.00	5.00
VB	25.00	39.00	6.5/5.5
VB	25.40	31.75	3/3.2
VB	25.40	31.75	3.20
VB	25.40	34.93	4.80
VB	26.00	31.00	3.00

 VB = Corrispondente GR INA
 VB = GR equivalent INA

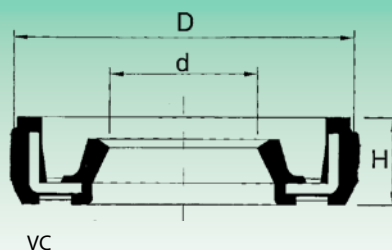

VC

Tipo Type	Dimensioni Dimensions (mm)		
	Diametro Diameter		H
	d	D	

Tipo Type	Dimensioni Dimensions (mm)		
	Diametro Diameter		H
	d	D	

Tipo Type	Dimensioni Dimensions (mm)		
	Diametro Diameter		H
	d	D	

Tipo Type	Dimensioni Dimensions (mm)		
	Diametro Diameter		H
	d	D	

VC	3.18	12.70	6.40
VC	4.00	9.00	3.00
VC	4.00	18.00	4.00
VC	4.50	26.00	5.00
VC	4.50	26.00	8.00
VC	4.80	14.50	4.00
VC	4.80	15.00	4.00
VC	5.00	10.00	4.00
VC	5.00	11.00	3.00
VC	5.00	14.00	4.00
VC	5.00	15.00	6.00
VC	5.50	9.00	3.00
VC	5.50	11.00	4.00
VC	6.00	10.00	2.50
VC	6.00	11.00	4.00
VC	6.00	11.00	4.50
VC	6.00	12.00	5.00
VC	6.00	14.00	4.00
VC	6.00	18.00	4.50
VC	6.00	19.00	5.00
VC	6.00	19.00	7.00
VC	6.00	22.00	7.00
VC	6.35	12.67	4.80
VC	6.40	12.70	3.20
VC	6.40	19.05	6.40
VC	7.00	13.00	4.00
VC	7.00	14.00	4.00
VC	7.00	20.00	5.00
VC	7.50	19.00	4.50
VC	7.80	13.70	2.50
VC	7.90	11.00	2.00
VC	7.90	14.28	6.00
VC	7.94	12.70	3.20
VC	8.00	12.00	3.00
VC	8.00	12.00	4.00
VC	8.00	14.00	4.00

VC	8.00	15.00	5.00
VC	8.00	16.00	4.00
VC	8.00	17.80	5.00
VC	8.60	14.00	3.00
VC	8.85	17.00	4.00
VC	8.85	20.00	4.00
VC	9.00	17.50	4.00
VC	9.00	18.00	5.00
VC	9.50	17.46	4.00
VC	9.50	19.05	6.40
VC	9.50	20.75	6.40
VC	9.53	19.05	4.30
VC	10.00	15.00	3.00
VC	10.00	15.00	4.00
VC	10.00	17.00	3.50
VC	10.00	17.00	5.00
VC	10.00	19.00	4.00
VC	10.00	20.00	5.00
VC	10.00	22.00	3.00
VC	10.00	24.00	4.00
VC	10.72	15.82	3.00
VC	10.80	20.00	9.00
VC	11.00	17.00	3.00
VC	11.00	17.00	6.00
VC	11.10	15.88	3.20
VC	11.90	25.00	4.50
VC	11.98	18.24	3.20
VC	12.00	16.00	2.50
VC	12.00	17.00	2.50
VC	12.00	17.00	5.00
VC	12.00	17.00	6.00
VC	12.00	18.00	3.00
VC	12.00	18.00	5.00
VC	12.00	19.00	3.00
VC	12.00	22.00	3.00
VC	12.00	22.00	4.00

VC	12.00	24.00	4.00
VC	12.00	25.00	4.50
VC	12.50	22.23	6.40
VC	12.65	23.01	2.20
VC	12.70	17.46	2.50
VC	12.70	19.05	3.20
VC	12.70	19.05	4.40
VC	12.70	22.23	3.20
VC	12.70	25.37	6.40
VC	12.70	25.40	4.50
VC	12.80	19.40	2.50
VC	13.00	19.00	3.00
VC	13.00	31.00	8.50
VC	13.00	32.00	9.00
VC	14.00	20.00	4.00
VC	14.00	22.00	4.00
VC	14.00	24.00	4.00
VC	14.00	25.00	5.00
VC	14.00	31.00	8.50
VC	14.29	24.41	5.00
VC	14.50	32.00	9.00
VC	15.00	19.00	6.00
VC	15.00	21.00	3.00
VC	15.00	21.00	5.00
VC	15.00	22.00	5.00
VC	15.00	23.00	3.00
VC	15.00	23.00	4.00
VC	15.00	25.00	4.00
VC	15.00	26.00	3.50
VC	15.00	30.00	5.00
VC	15.10	23.75	4.50
VC	15.32	20.57	2.40
VC	15.60	25.37	6.40
VC	15.77	26.00	2.16
VC	15.77	26.00	2.16
VC	15.88	20.64	2.40

VC	15.88	20.64	3.20
VC	15.88	22.23	2.50
VC	15.88	22.23	3.20
VC	15.88	23.81	4.80
VC	16.00	20.00	2.50
VC	16.00	22.00	3.00
VC	16.00	22.30	2.40
VC	16.00	22.70	2.00
VC	16.00	23.00	3.00
VC	16.00	23.00	5.00
VC	16.00	24.00	4.00
VC	16.00	25.00	5.00
VC	16.00	30.00	3.00
VC	16.00	30.00	5.00
VC	17.00	21.00	3.20
VC	17.00	22.00	5.00
VC	17.00	22.00	6.00
VC	17.00	23.00	3.00
VC	17.00	26.00	3.00
VC	17.00	30.00	5.00
VC	17.00	35.00	4.80
VC	17.46	31.75	6.40
VC	18.00	22.00	7.00
VC	18.00	24.00	4.00
VC	19.00	26.00	4.00
VC	19.05	25.40	3.20
VC	19.05	26.99	4.60
VC	19.05	27.05	4.60
VC	19.05	31.75	6.40
VC	20.00	25.00	2.50
VC	20.00	25.40	3.20
VC	20.00	26.00	4.00
VC	20.00	28.00	5.00
VC	20.00	30.00	4.00
VC	20.00	30.00	7.00
VC	20.00	32.00	5.00

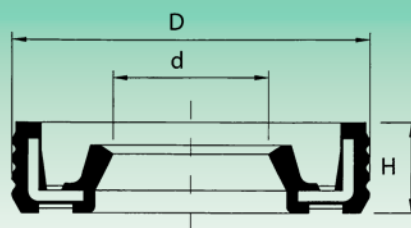

VCW

Sigla Designation	Peso (g) Weight (g) ≈	Dimensioni (mm) Dimensions (mm)		
		d	D	h -0.2 +0.4
VCW	-	6	15	3.30
VCW	-	7	15	3
VCW	-	7	15	5
VCW	0.41	8	12	3
VCW	-	8	14	4
VCW	0.65	8	15	3
VCW	0.44	9	13	3
VCW	0.69	9	16	3
VCW	0.50	10	14	3
VCW	0.90	10	17	3
VCW	-	10	29.70	3.00
VCW	0.60	12	16	3
VCW	0.90	12	18	3
VCW	1.00	12	19	3
VCW	-	12	29.55	3
VCW	-	12	29.70	3
VCW	0.90	13	19	3
VCW	1.00	14	20	3
VCW	1.10	14	21	3
VCW	1.30	14	22	3
VCW	-	14	22	4
VCW	-	14	26.00	3
VCW	1.00	15	21	3
VCW	-	16	20	2.5
VCW	1.30	16	22	3
VCW	1.30	16	24	3
VCW	1.60	16	25	3
VCW	-	17	22	5
VCW	1.30	17	23	3
VCW	1.50	17	25	3
VCW	1.20	18	24	3
VCW	-	18	24	4
VCW	-	18	26	4
VCW	2.0	19	27	4
VCW	-	20	26	3
VCW	1.80	20	26	4
VCW	2.10	20	28	4
VCW	2.2	21	29	4
VCW	1.80	22	28	4
VCW	2.20	22	30	4
VCW	2.50	24	32	4
VCW	2.30	25	32	4
VCW	2.5	25	33	4
VCW	-	25	34	4
VCW	2.60	25	35	4
VCW	2.6	26	34	4
VCW	-	27	35	4

Sigla Designation	Peso (g) Weight (g) ≈	Dimensioni (mm) Dimensions (mm)		
		d	D	h -0.2 +0.4
VCW	2.40	28	35	4
VCW	3.1	28	37	4
VCW	3.2	29	38	4
VCW	2.70	30	37	4
VCW	-	30	38	4
VCW	3.60	30	40	4
VCW	-	30	50	5
VCW	-	30	55	5
VCW	-	30	56	5
VCW	-	31	38	4
VCW	3.70	32	42	4
VCW	5.10	32	45	4
VCW	-	33	40	3
VCW	3.00	35	42	4
VCW	-	35	40	10
VCW	4.10	35	45	4
VCW	-	35	45	5
VCW	4.00	37	47	4
VCW	-	38	45	4
VCW	4.40	38	48	4
VCW	3.30	40	47	4
VCW	4.60	40	50	4
VCW	4.80	40	52	5
VCW	4.70	42	52	4
VCW	-	42	52.50	5
VCW	-	42	55	6
VCW	4.8	43	53	4
VCW	-	45	50	4
VCW	3.80	45	52	4
VCW	5.2	45	55	4
VCW	-	45	71	5
VCW	-	46	58	5
VCW	-	46	54	4
VCW	4.50	50	58	4
VCW	-	50	60.5	5
VCW	10.4	50	62	5
VCW	-	53	65	5
VCW	7.1	55	63	5
VCW	-	58	70.50	5
VCW	-	63	75	5
VCW	-	70	78	4
VCW	9.00	70	78	5
VCW	-	72	85.50	5
VCW	-	76	90.50	6
VCW	-	80	95	5
VCW	-	90	105	5

 VCW: Corrispondente G INA
 VCW: G equivalent INA



Anelli di tenuta a due labbri (serie SD)

Bearings rings double lip (SD serie)

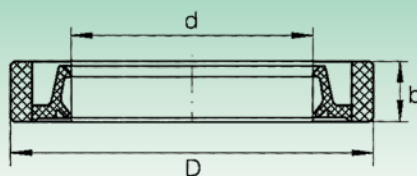
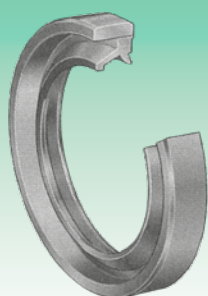

Sigla Designation	Peso (g) Weight (g) ≈	Dimensioni (mm) Dimensions (mm)		
		d	D	b +0,4 0,2
SD 8X15X3	0.4	8	15	3
SD 10X17X3	0.44	10	17	3
SD 12X18X3	0.5	12	18	3
SD 12X19X3	0.6	12	19	3
SD 14X20X3	0.5	14	20	3
SD 14X22X3	0.7	14	22	3
SD 15X21X3	0.5	15	21	3
SD 15X23X3	0.7	15	23	3
SD 16X22X3	0.6	16	22	3
SD 16X24X3	0.8	16	24	3
SD 17X23X3	0.6	17	23	3
SD 17X25X3	0.8	17	25	3
SD 18X24X3	0.6	18	24	3
SD 18X26X4	1.1	18	26	4
SD 19X27X4	1.1	19	27	4
SD 20X26X4	0.8	20	26	4
SD 20X28X4	1.1	20	28	4
SD 22X28X4	0.9	22	28	4
SD 22X30X4	1.3	22	30	4
SD 25X32X4	1.3	25	32	4
SD 25X33X4	1.3	25	33	4
SD 25X35X4	1.9	25	35	4
SD 26X34X4	1.4	26	34	4
SD 28X35X4	1.3	28	35	4
SD 30X37X4	1.3	30	37	4
SD 30X40X4	2.1	30	40	4
SD 32X42X4	2.4	32	42	4
SD 35X42X4	1.5	35	42	4
SD 35X45X4	2.5	35	45	4
SD 37X47X4	2.7	37	47	4
SD 38X48X4	2.8	38	48	4
SD 40X47X4	1.7	40	47	4
SD 40X50X4	2.9	40	50	4
SD 40X50X4	2.9	40	50	4
SD 40X52X5	4.5	40	52	5
SD 42X52X4	3	42	52	4
SD 45X52X4	1.9	45	52	4
SD 45X55X4	3.2	45	55	4
SD 50X58X4	2.4	50	58	4
SD 50X62X5	5.5	50	62	5







ANELLI ELASTICI

ELASTIC RINGS

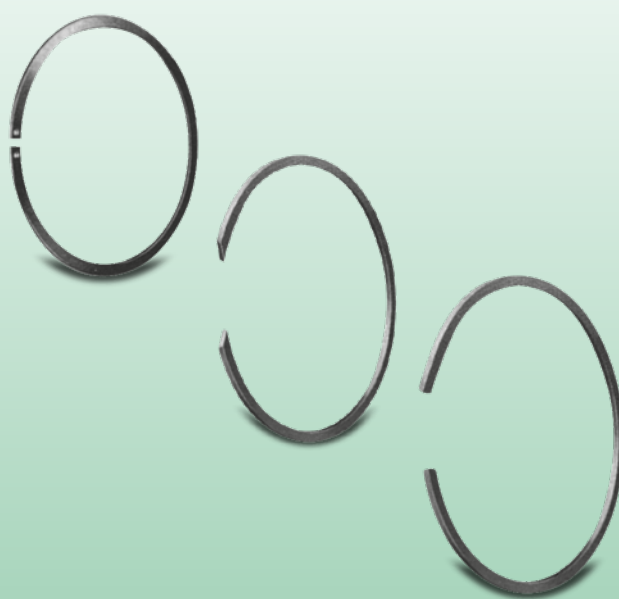





Anelli elastici

Elastic rings



Gli anelli elastici per alberi (AE) e per fori (AF) hanno come scopo principale di evitare qualsiasi tipo di spostamento assiale degli anelli dei cuscinetti o delle gabbie a rullini. Sono costruiti in acciaio e garantiscono il minimo ingombro radiale. Si consiglia inoltre di montare una piccola ralla tra gli anelli, in quanto questo evita qualsiasi tipo di strisciamento sul fianco delle gabbie. Inoltre si raccomanda di attenersi ai valori indicati nelle tabelle per ciò che riguarda il numero di giri massimo ammissibile, onde evitare che gli anelli elastici possano uscire dalla sede di alloggiamento. Gli anelli per alberi (AES) hanno le medesime caratteristiche degli anelli sopraindicati, solo che presentano una maggiore altezza radiale, garantendo un maggior precarico. E' consigliato l'utilizzo di apposite pinze essendo stati previsti dei fori per facilitarne il montaggio. Sono particolarmente adatti per la sicurezza assiale dei cuscinetti a rullini e rulli cilindrici.

Elastic rings for shafts (AE) and for bores (AF) have as their first aim, the target of avoiding any axial movement of bearing rings or of needle roller cages.

They are made of steel and assure lowest radial dimension.

A good expedient is to assemble a small thrust bearing between the rings, as this avoids any kinds of sliding on side cages.

For maximum allowed revolutions, please check tables: respect them means avoiding that the elastic rings come out from their housing.

(AES) rings for shafts are the same as above, but their radial height is bigger: this guarantees a greater pre-loading.

Seen that mounting bores are present on the rings we suggest to use pliers, during assembling operations.

These elastic rings are particularly suitable for needle roller bearings and cylindrical rollers axial safety.

Tipo-Type	Sigla INA equivalent	Caratteristiche-Characteristics
AF	BR	Per fori <i>For bores</i>
AE	WR	Per alberi (esecuzione normale) <i>For shafts (normal execution)</i>
AES	WRE	Per alberi (esecuzione rinforzata) <i>For shafts (reinforced execution)</i>



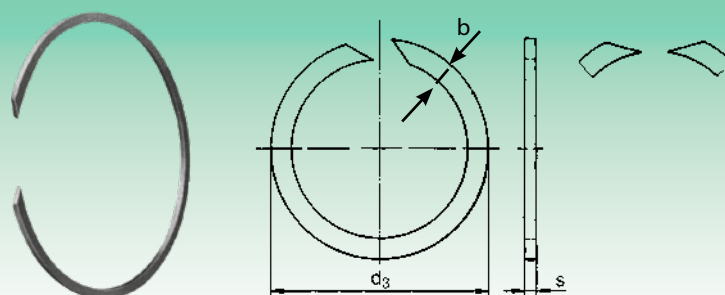

Sigla Designation	Peso per 1.000 pz. (kg.) Weight for 1.000 pcs (kg.)	Dimensioni (mm) Dimensions (mm)				
		Foro Hole d_1	Anello Ring d_2 min.	Larghezza Width b -0,1	Spessore Thickness s -0,1	Gola Groove d_2 h 11
AF 7	0.09	7	7.5	1.00	0.8	7.4
AF 8	0.10	8	8.5	1.00	0.8	8.4
AF 9	0.13	9	9.5	1.10	0.8	9.4
AF 10	0.15	10	10.6	1.20	0.8	10.5
AF 11	0.21	11	11.6	1.30	1	11.5
AF 12	0.25	12	12.7	1.30	1	12.5
AF 13	0.28	13	13.8	1.30	1	13.6
AF 14	0.31	14	14.8	1.30	1	14.6
AF 15	0.34	15	15.8	1.30	1	15.6
AF 16	0.53	16	16.8	1.75	1.2	16.6
AF 17	0.55	17	17.8	1.75	1.2	17.6
AF 18	0.68	18	18.9	1.75	1.2	18.6
AF 19	0.72	19	19.9	1.75	1.2	19.6
AF 20	0.76	20	21	1.75	1.2	20.6
AF 21	0.79	21	22	1.75	1.2	21.6
AF 22	0.81	22	23	1.75	1.2	22.6
AF 23	0.88	23	24	1.75	1.2	23.6
AF 24	0.90	24	25.2	1.75	1.2	24.8
AF 25	0.91	25	26.2	1.75	1.2	25.8
AF 26	0.98	26	27.2	1.75	1.2	26.8
AF 27	1.11	27	28.2	1.75	1.2	27.8
AF 28	1.13	28	29.2	1.75	1.2	28.8
AF 29	1.15	29	30.2	1.75	1.2	29.8
AF 30	2.00	30	31.4	2.30	1.5	31
AF 31	2.03	31	32.4	2.30	1.5	32
AF 32	2.11	32	33.4	2.30	1.5	33
AF 33	2.26	33	34.4	2.30	1.5	34
AF 34	2.34	34	35.4	2.30	1.5	35
AF 35	2.36	35	36.4	2.30	1.5	36
AF 37	2.53	37	38.8	2.30	1.5	38.2
AF 38	2.61	38	39.8	2.30	1.5	39.2
AF 39	2.67	39	40.8	2.30	1.5	40.2
AF 40	2.80	40	41.8	2.30	1.5	41.2
AF 42	2.92	42	43.8	2.30	1.5	43.2
AF 43	3.03	43	44.8	2.30	1.5	44.2
AF 44	3.11	44	45.8	2.30	1.5	45.2
AF 45	3.25	45	46.8	2.30	1.5	46.2
AF 46	3.28	46	47.8	2.30	1.5	47.2
AF 47	3.29	47	48.8	2.30	1.5	48.2

Sigla Designation	Peso per 1.000 pz. (kg.) Weight for 1.000 pcs (kg.)	Dimensioni (mm) Dimensions (mm)				
		Foro Hole d_1	Anello Ring d_2 min.	Larghezza Width b -0,1	Spessore Thickness s -0,1	Gola Groove d_2 h 11
AF 48	3.45	48	49.8	2.3	1.5	49.2
AF 50	3.57	50	51.8	2.3	1.5	51.2
AF 52	3.58	52	54.3	2.3	1.5	53.5
AF 53	3.82	53	55.3	2.3	1.5	54.5
AF 55	3.93	55	57.3	2.3	1.5	56.5
AF 57	4.12	57	59.3	2.3	1.5	58.5
AF 58	4.13	58	60.3	2.3	1.5	59.5
AF 60	4.28	60	62.3	2.3	1.5	61.5
AF 62	4.42	62	64.3	2.3	1.5	63.5
AF 63	4.50	63	65.3	2.3	1.5	64.5
AF 65	4.72	65	67.3	2.3	1.5	66.5
AF 68	4.90	68	70.3	2.3	1.5	69.5
AF 70	4.93	70	72.3	2.3	1.5	71.5
AF 72	8.49	72	74.6	2.8	2	73.8
AF 73	8.52	73	75.6	2.8	2	74.8
AF 74	8.60	74	76.6	2.8	2	75.8
AF 76	8.89	76	78.6	2.8	2	77.8
AF 78	9.05	78	80.6	2.8	2	79.8
AF 79	9.07	79	81.6	2.8	2	80.8
AF 80	9.22	80	82.6	2.8	2	81.8
AF 81	9.31	81	83.6	2.8	2	82.8
AF 82	9.45	82	84.6	2.8	2	83.8
AF 83	9.63	83	85.6	2.8	2	84.8
AF 86	9.91	86	88.6	2.8	2	87.8
AF 88	15.40	88	91	2.8	2.5	90
AF 90	15.60	90	93	3.4	2.5	92
AF 92	16.60	92	95	3.4	2.5	94
AF 93	16.80	93	96	3.4	2.5	95
AF 95	16.90	95	98	3.4	2.5	97
AF 97	17.10	97	100	3.4	2.5	99
AF 98	17.50	98	101	3.4	2.5	100
AF 100	17.90	100	103.3	3.4	2.5	102.3
AF 102	18.40	102	105.3	3.4	2.5	104.3
AF 103	18.50	103	106.3	3.4	2.5	105.3
AF 105	18.70	105	108.3	3.4	2.5	107.3
AF 107	19.10	107	110.3	3.4	2.5	109.3
AF 108	19.30	108	111.3	3.4	2.5	110.3
AF 110	19.80	110	113.4	3.4	2.5	112.3
AF 112	20.30	112	115.4	3.4	2.5	114.3



Anelli elastici per fori (serie AF)

Elastic rings for bores (AF series)

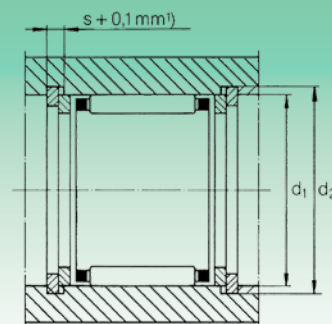
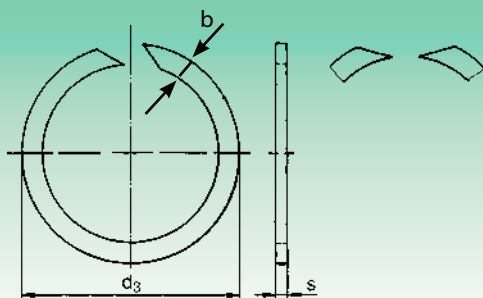

Dimensioni di montaggio
Mounting dimension

Sigla Designation	Peso per 1.000 pz. (kg.) Weight for 1.000 pcs (kg.)	Dimensioni (mm) Dimensions (mm)				
		Foro Hole d ₁	Anello Ring d ₃ min.	Larghezza Width b -0,1	Spessore Thickness s -0,1	Gola Groove d ₂ h 11
AF 113	20.50	113	116.4	3.4	2.5	115.3
AF 115	20.60	115	118.4	3.4	2.5	117.3
AF 117	20.80	117	120.4	3.4	2.5	119.3
AF 118	21.10	118	121.4	3.4	2.5	120.3
AF 120	21.40	120	123.6	3.4	2.5	122.3
AF 123	22.00	123	126.6	3.4	2.5	125.3
AF 125	22.50	125	128.6	3.4	2.5	127.3
AF 127	23.00	127	130.6	3.4	2.5	129.3
AF 130	23.40	130	133.7	3.4	2.5	132.3
AF 133	24.40	133	136.7	3.4	2.5	135.3
AF 135	25.00	135	138.7	3.4	2.5	137.3
AF 137	25.30	137	140.7	3.4	2.5	139.3
AF 140	29.30	140	144.1	4.0	2.5	142.6
AF 143	30.10	143	147.1	4.0	2.5	145.6
AF 150	31.90	150	154.2	4.0	2.5	152.6
AF 153	32.60	153	157.2	4.0	2.5	155.6
AF 160	34.40	160	164.3	4.0	2.5	162.6
AF 163	34.60	163	167.3	4.0	2.5	165.6
AF 165	34.90	165	169.3	4.0	2.5	167.6
AF 170	36.20	170	174.4	4.0	2.5	172.6
AF 173	37.10	173	177.4	4.0	2.5	175.6
AF 175	37.30	175	179.4	4.0	2.5	177.6

Sigla Designation	Peso per 1.000 pz. (kg.) Weight for 1.000 pcs (kg.)	Dimensioni (mm) Dimensions (mm)				
		Foro Hole d ₁	Anello Ring d ₃ min.	Larghezza Width b -0,1	Spessore Thickness s -0,1	Gola Groove d ₂ h 11
AF 180	38.30	180	184.5	4.0	2.5	182.6
AF 183	41.00	183	187.5	4.0	2.5	185.6
AF 190	61.30	190	194.9	5.0	3	193
AF 195	61.60	195	199.9	5.0	3	198
AF 200	64.50	200	205	5.0	3	203
AF 205	66.40	205	210	5.0	3	208
AF 220	72.40	220	225.2	5.0	3	223
AF 230	75.20	230	235.3	5.0	3	233
AF 250	84.20	250	255.5	5.0	3	253
AF 270	174.0	270	277.7	7.5	4	275
AF 280	184.0	280	287.8	7.5	4	285
AF 300	196.0	300	307.9	7.5	4	305
AF 320	203.0	320	328.2	7.5	4	325
AF 325	206.0	325	333.2	7.5	4	330
AF 355	231.0	355	363.4	7.5	4	360
AF 375	240.0	375	383.6	7.5	4	380
AF 385	248.0	385	393.7	7.5	4	390
AF 395	257.0	395	403.8	7.5	4	400
AF 400	260.0	400	408.9	7.5	4	405
AF 420	277.0	420	429.1	7.5	4	425
AF 440	294.0	440	449.3	7.5	4	445



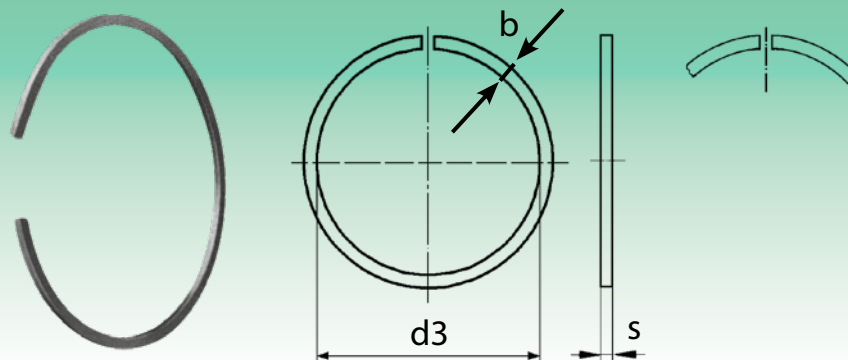

Sigla Designation	Peso per 1.000 pz. (kg.) Weight for 1.000 pcs (kg.)	Dimensioni (mm) Dimensions (mm)				
		Foro Hole d_1	Anello Ring d_3 max.	Larghezza Width b -0,1	Spessore Thickness s -0,1	Gola Groove d_2 h_{11}
AE 4	0.02	4	3.7	0.80	0.5	3.8
AE 5	0.05	5	4.7	1.00	0.5	4.8
AE 6	0.09	6	5.6	1.10	0.7	5.7
AE 7	0.12	7	6.5	1.20	0.7	6.7
AE 8	0.20	8	7.4	1.30	1	7.6
AE 9	0.24	9	8.4	1.30	1	8.6
AE 10	0.25	10	9.4	1.30	1	9.6
AE 11	0.29	11	10.2	1.30	1	10.5
AE 12	0.30	12	11.2	1.30	1	11.5
AE 14	0.50	14	13.1	1.50	1.2	13.5
AE 15	0.66	15	14	1.75	1.2	14.4
AE 16	0.69	16	15	1.75	1.2	15.4
AE 17	0.72	17	16	1.75	1.2	16.4
AE 18	0.75	18	17	1.75	1.2	17.4
AE 19	0.80	19	17.9	1.75	1.2	18.4
AE 20	0.84	20	18.7	1.75	1.2	19.2
AE 21	0.87	21	19.7	1.75	1.2	20.2
AE 22	0.91	22	20.7	1.75	1.2	21.2
AE 24	0.99	24	22.5	1.75	1.2	23
AE 25	1.00	25	23.5	1.75	1.2	24
AE 26	1.10	26	24.5	1.75	1.2	25
AE 28	2.11	28	26.5	2.30	1.5	27
AE 29	2.20	29	27.5	2.30	1.5	28
AE 30	2.33	30	28.5	2.30	1.5	29
AE 32	2.41	32	30.2	2.30	1.5	30.8
AE 35	2.51	35	33.2	2.30	1.5	33.8
AE 37	2.72	37	35.2	2.30	1.5	35.8
AE 38	2.83	38	36.2	2.30	1.5	36.8
AE 40	2.91	40	37.8	2.30	1.5	38.5

Sigla Designation	Peso per 1.000 pz. (kg.) Weight for 1.000 pcs (kg.)	Dimensioni (mm) Dimensions (mm)				
		Foro Hole d_1	Anello Ring d_3 max.	Larghezza Width b -0,1	Spessore Thickness s -0,1	Gola Groove d_2 h_{11}
AE 90	16.00	90	87	3.40	2.5	88
AE 95	18.20	95	92	3.40	2.5	93
AE 100	18.90	100	97	3.40	2.5	98
AE 105	20.70	105	101.7	3.40	2.5	102.7
AE 110	20.90	110	106.6	3.40	2.5	107.7
AE 115	22.10	115	111.6	3.40	2.5	112.7
AE 120	24.10	120	116.5	3.40	2.5	117.7
AE 125	25.10	125	121.4	3.40	2.5	122.7
AE 130	26.60	130	126.3	3.40	2.5	127.7
AE 135	30.20	135	131	4.00	2.5	132.4
AE 140	31.10	140	135.9	4.00	2.5	137.4
AE 145	32.60	145	140.9	4.00	2.5	142.4
AE 150	32.80	150	145.8	4.00	2.5	147.4
AE 155	34.70	155	150.8	4.00	2.5	152.4
AE 160	36.60	160	155.7	4.00	2.5	157.4
AE 165	37.40	165	160.7	4.00	2.5	162.4
AE 170	38.50	170	165.6	4.00	2.5	167.4
AE 175	39.40	175	170.6	4.00	2.5	172.4
AE 180	61.20	180	175.2	5.00	3	177
AE 185	63.90	185	180.1	5.00	3	182
AE 190	65.90	190	185.1	5.00	3	187
AE 195	67.50	195	190.1	5.00	3	192
AE 200	68.40	200	195	5.00	3	197
AE 210	72.00	210	204.9	5.00	3	207
AE 220	76.30	220	214.8	5.00	3	217
AE 225	78.00	225	219.8	5.00	3	222
AE 230	79.80	230	224.7	5.00	3	227
AE 240	81.70	240	234.6	5.00	3	237
AE 260	179.0	260	252.4	7.50	4	255



Anelli elastici per alberi esecuzione normale (serie AE)

Elastic rings for shafts normal execution (AE series)

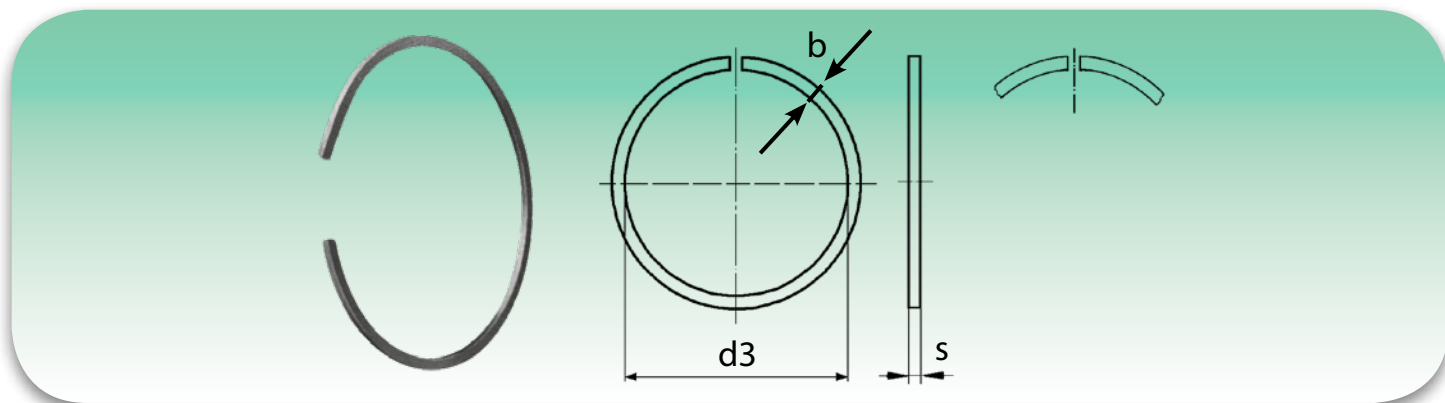

Sigla Designation	Peso per 1.000 pz. (kg.) Weight for 1.000 pcs (kg.)	Dimensioni (mm) Dimensions (mm)				
		Foro Hole d _i	Anello Ring d _s max.	Larghezza Width b -0,1	Spessore Thickness s -0,1	Gola Groove d _s h 11
AE 42	3.10	42	39.8	2,30	1.5	40.5
AE 43	3.25	43	40.8	2,30	1.5	41.5
AE 44	3.32	44	41.8	2,30	1.5	42.5
AE 45	3.39	45	42.8	2,30	1.5	43.5
AE 47	3.48	47	44.8	2,30	1.5	45.5
AE 50	3.73	50	47.8	2,30	1.5	48.5
AE 52	3.92	52	49.8	2,30	1.5	50.5
AE 55	4.11	55	52.6	2,30	1.5	53.5
AE 58	4.40	58	55.6	2,30	1.5	56.5
AE 60	4.55	60	57.6	2,30	1.5	58.5
AE 62	4.57	62	59.6	2,30	1.5	60.5
AE 63	4.58	63	60.6	2,30	1.5	61.5
AE 65	4.64	65	62.6	2,30	1.5	63.5
AE 68	8.59	68	65.4	2,80	2	66.2
AE 70	8.71	70	67.4	2,80	2	68.2
AE 72	8.80	72	69.4	2,80	2	70.2
AE 73	8.90	73	70.4	2,80	2	71.2
AE 75	9.32	75	72.4	2,80	2	73.2
AE 80	9.67	80	77.4	2,80	2	78.2
AE 85	16.00	85	82	3,40	2.5	83

Sigla Designation	Peso per 1.000 pz. (kg.) Weight for 1.000 pcs (kg.)	Dimensioni (mm) Dimensions (mm)				
		Foro Hole d _i	Anello Ring d _s max.	Larghezza Width b -0,1	Spessore Thickness s -0,1	Gola Groove d _s h 11
AE 265	185.2	265	257.4	7,50	4	260
AE 270	197.7	270	262.3	7,50	4	265
AE 280	198.7	280	272.2	7,50	4	275
AE 285	199.5	285	277.2	7,50	4	280
AE 290	205.3	290	282.1	7,50	4	285
AE 300	214.2	300	292.1	7,50	4	295
AE 305	219.4	305	297.1	7,50	4	300
AE 310	223.1	310	302	7,50	4	305
AE 320	225.3	320	311.9	7,50	4	315
AE 330	228.6	330	321.7	7,50	4	325
AE 340	239.3	340	331.6	7,50	4	335
AE 350	251.2	350	341.5	7,50	4	345
AE 360	253.1	360	351.4	7,50	4	355
AE 370	259.2	370	361.4	7,50	4	365
AE 380	268.0	380	371.2	7,50	4	375
AE 390	273.9	390	381.2	7,50	4	385
AE 400	281.1	400	391.2	7,50	4	395
AE 420	540.0	420	410	12,0	4.5	414
AE 460	590.0	460	449.5	12,0	4.5	454

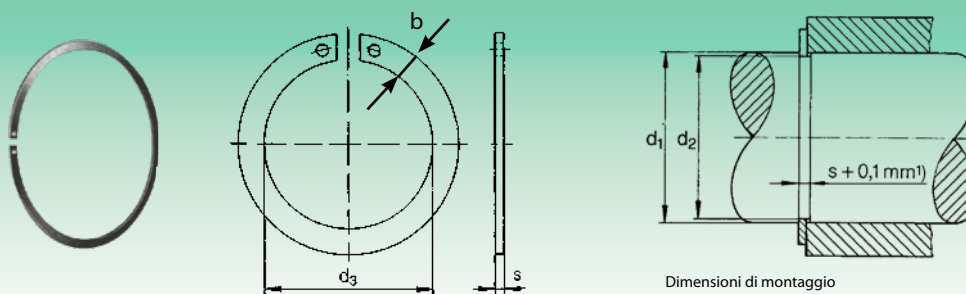

 Dimensioni di montaggio
 Mounting dimension

Sigla Designation	Peso per 1.000 pz. (kg.) Weight for 1.000 pcs (kg.)	Dimensioni (mm) Dimensions (mm)				
		Foro Hole d_1	Anello Ring d_3 max.	Larghezza Width b -0,2	Spessore Thickness s -0,2	Gola Groove d_2 h_{11}
AES 42	5.70	42	39.3	3.6	1.5	39.8
AES 47	6.35	47	44.3	3.6	1.5	44.8
AES 55	7.36	55	51.8	3.6	1.5	52.8
AES 62	8.26	62	58.8	3.6	1.5	59.8
AES 68	16.25	68	64.6	4.8	2	65.8
AES 75	17.88	75	71.6	4.8	2	72.8
AES 80	19.05	80	76.6	4.8	2	77.8
AES 90	32.47	90	86.3	5.8	2.5	87.8
AES 95	34.23	95	91.3	5.8	2.5	92.8
AES 100	36.08	100	95.9	5.8	2.5	97.4
AES 110	39.33	110	105.4	5.8	2.5	107.1
AES 115	41.09	115	110.4	5.8	2.5	112.1
AES 125	58.32	125	120.1	7.5	2.5	122.1
AES 130	60.50	130	124.9	7.5	2.5	127.1
AES 140	64.91	140	134.8	7.5	2.5	137
AES 145	67.18	145	139.8	7.5	2.5	142
AES 150	69.28	150	144.4	7.5	2.5	147
AES 160	73.70	160	154.1	7.5	2.5	157
AES 170	77.92	170	163.4	7.5	2.5	167
AES 180	131.09	180	173	9.8	3	176

Sigla Designation	Peso per 1.000 pz. (kg.) Weight for 1.000 pcs (kg.)	Dimensioni (mm) Dimensions (mm)				
		Foro Hole d_1	Anello Ring d_3 max.	Larghezza Width b -0,2	Spessore Thickness s -0,2	Gola Groove d_2 h_{11}
AES 190	138.23	190	183	9.8	3	186
AES 200	145.00	200	192.5	9.8	3	196
AES 210	151.78	210	202	9.8	3	206
AES 220	158.91	220	212	9.8	3	216
AES 225	200.88	225	217	12.0	3	221
AES 230	205.24	230	222	12.0	3	226
AES 240	213.54	240	231.5	12.0	3	236
AES 260	359.35	260	249.5	14.0	4	254
AES 270	372.25	270	259	14.0	4	264
AES 280	385.84	280	269	14.0	4	274
AES 290	399.43	290	279	14.0	4	284
AES 300	412.33	300	288.5	14.0	4	294
AES 310	495.52	310	298	16.2	4	304
AES 320	511.24	320	308	16.2	4	314
AES 340	541.89	340	327.5	16.2	4	334
AES 360	572.55	360	347	16.2	4	354
AES 380	600.85	380	365	16.2	4	374
AES 400	650.00	400	385	16.2	4	394
AES 420	930.00	420	405	20.0	4.5	413
AES 460	1 011.0	460	442	20.0	4.5	453



CUSCINETTI PER MOVIMENTAZIONE LINEARE

LINEAR BEARINGS

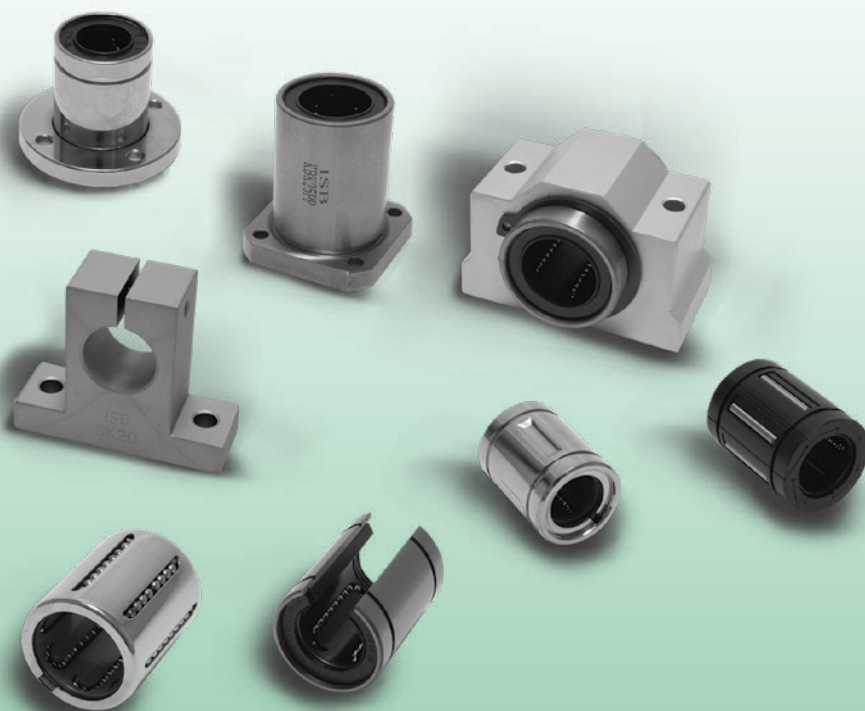





Caratteristiche tecniche

I prodotti ISB per la movimentazione lineare su albero sono stati ideati per offrire buone prestazioni mantenendo un minimo coefficiente di attrito. Il loro impiego trova applicazione in svariati campi, quali parti mobili di macchine confezionatrici, macchine utensili, macchine per la lavorazione dell'alluminio e del legno, sistemi di protezione e copertura, robots, sistemi di posizionamento e strumentazioni di misura e controllo.

Technical characteristics

ISB linear bearings have been made to offer a good performance by keeping a minimum friction coefficient. They apply to different sectors, such as package machines, tool machines, wood and aluminium working machines, protection and covering systems, robots, positioning systems and measurement instruments too.





Capacità di carico e durata

La capacità di carico è definita dalle condizioni di:

- Carico statico
- Carico dinamico

Carico statico

L'indice utilizzato per valutare la capacità di un sistema lineare ad assorbire i carichi e /o momenti statici applicato è la:

- Capacità di carico statica C_0

La capacità di carico statica C_0 (o coefficiente di carico statico) è definita come quel carico statico di intensità e direzione costante che determina, nel punto di massima sollecitazione tra le parti in contatto, una deformazione permanente pari a 1/10000 del diametro dell'elemento volvente.

I valori di C_0 sono riportati nelle tabelle dimensionali.

Coefficiente di sicurezza statico a_s

Il coefficiente di sicurezza statico a_s (o fattore di sicurezza statica) è dato dalla seguente relazione:

$$a_s = f_c \times f_b \times C_0 / P$$

dove:

- a_s = coefficiente di sicurezza statico
- f_c = fattore di contatto
- f_b = coefficiente di layout ricircoli
- C_0 = capacità di carico statica [N]
- P = carico massimo applicato [N]

Di seguito vengono definiti i fattori f_c e f_b :

Fattore di contatto f_c

Se due o più manicotti vengono montati su una stessa guida, la durata deve essere penalizzata per effetto di una non completa uniformità di distribuzione dei carichi applicati sui manicotti stessi.

Tabella - Fattore di contatto f_c

Numero manicotti per singolo albero Number of linear bearings for shaft	f_c
1	1.0
2	0.81
3	0.72
4	0.66
5	0.61

Load rating and life

Load rating is defined for conditions of:

- Static load
- Dynamic load

Static load

The index used to value the static load capacity for a linear system is:

- Static load rating capacity C_0

Static load rating capacity C_0 is defined as the constant load rating that generates a remaining deformation of 1/10000 of the rolling element diameter in the zone with the maximum stress.

C_0 values are shown on dimensional tables.

Static safety factor a_s

Static safety factor is calculated through the following formula:

where:

- a_s = static safety factor
- f_c = contact factor
- f_b = layout factor
- C_0 = static load rating capacity [N]
- P = maximum load applied [N]

Definition of f_c and f_b factors as follows:

Contact factor f_c

If two or more linear bearings are mounted on the same shaft, their nominal life will have to be reduced by a not uniform distribution of applied loads.

Table - Contact factor f_c

Fattore f_B

Per sistemi lineari del tipo asta-manicotto, la capacità di carico statica C_0 può essere maggiorata in funzione della posizione del carico F rispetto alla posizione delle sfere; questo è dovuto ad una migliore distribuzione del carico sugli elementi volventi. Lo schema seguente riporta i coefficienti f_B :

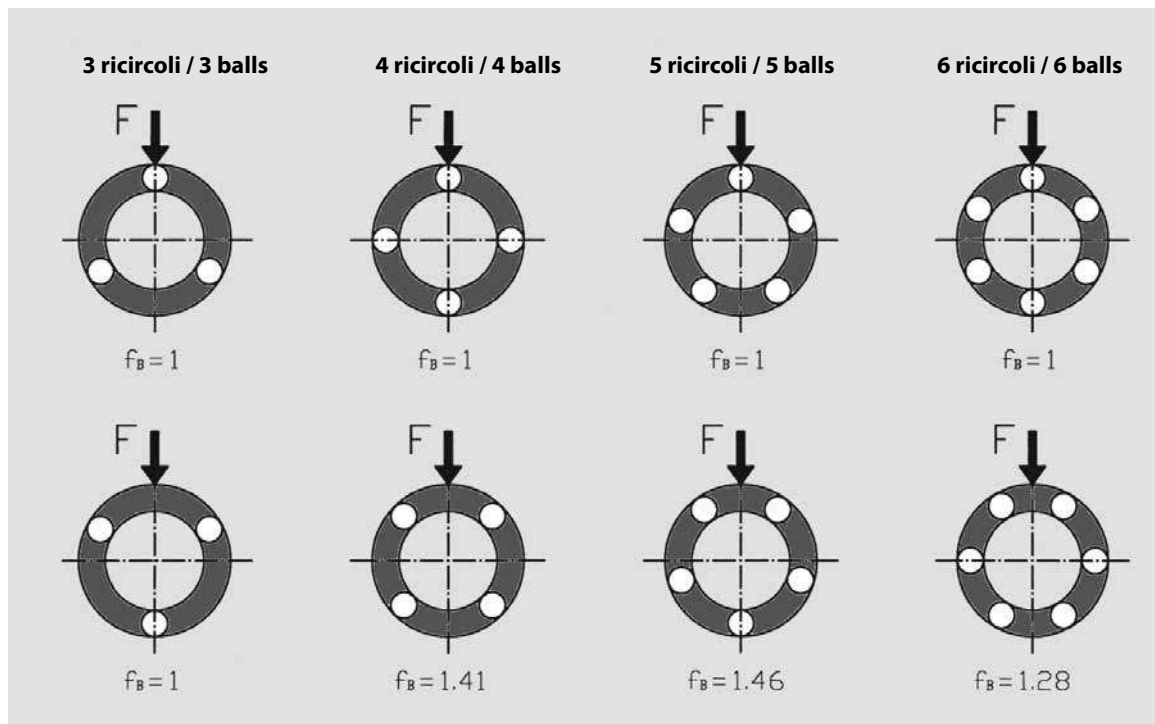

La necessità di avere un coefficiente di sicurezza statico $a_s > 1$ deriva dalla possibile presenza di urti e/o vibrazioni, momenti di avvio e arresti, carichi accidentali che pregiudicherebbero la capacità del sistema qualora non se ne fosse tenuto conto. Inoltre, per i sistemi lineari del tipo asta-manicotto con supporti asta del tipo SH o SK (supporti di estremità), la scelta degli elementi è funzione non solamente dei carichi in gioco, ma soprattutto della flessione dell'albero; maggiore è tale deformazione e maggiore dovrà essere il sovradimensionamento del manicotto. A titolo esemplificativo, per una freccia d'inflessione di 0.01 mm l'elemento deve essere sovradimensionato.

La tabella seguente fornisce dei valori minimi di riferimento per il coefficiente di sicurezza statico a_s .

Tabella - Coefficiente di sicurezza statico a_s

Condizioni di funzionamento <i>Working conditions</i>	a_s minimi <i>a_s minimum</i>
Statico e piccole flessioni Static and very small deformations	1.0 ÷ 2.0
Dinamico con leggere flessioni Dynamic with light deformations	2.0 ÷ 4.0
Dinamico con urti, vibrazioni e leggere flessioni Dynamic with impacts, vibrations and light deformations	3.0 ÷ 5.0

Factor f_B

For linear bearings, the static load rating capacity C_0 could be increased by layout of balls compared with the direction of the applied load F ; this is due to a better distribution of load on balls.

The following picture shows the f_B coefficients:

The necessity to have a static safety factor $a_s > 1$ comes from the possible presence of impacts or vibrations, start moments and stops, accidental loads that will be very dangerous if they are not taken into account. Moreover, as far as shafts supported by SH or SK supports are concerned, the choice of the size doesn't simply depend on the applied loads, but on the shaft elastic deformation too. The higher this deformation, the higher should be the oversize of the bearing. For example, a deformation of 0.01 mm implies an increase of the bearing size.

The following table shows minimal a_s values.

Table - Static safety factor a_s



Carico dinamico

L'indice utilizzato per valutare la capacità del sistema lineare ad assorbire i carichi dinamici applicati è la:

- Capacità di carico dinamica C

La capacità di carico dinamica C (o coefficiente di carico dinamico) è definita come quel carico dinamico di intensità e direzione costante che determina una durata nominale di 50 km di percorso di spostamento; la durata viene intesa come il percorso teorico in assenza di segni di affaticamento.

La capacità di carico dinamica C di un sistema lineare del tipo asta-manicotto è limitata da:

- Carichi e/o momenti applicati
- Flessioni dell'albero
- Velocità di funzionamento
- Ciclo di funzionamento

I valori di C sono riportati nelle tabelle dimensionali.

Durata nominale L

La durata nominale L (intesa come quel percorso teorico raggiunto da almeno il 90% di un significativo quantitativo di uguali cuscinetti a sfere senza formazione di segnali di affaticamento), è data dalla seguente relazione:

$$L = (C/P)^3 \times 50$$

dove:

- L = durata nominale [km]
- C = capacità di carico dinamica [N]
- P = carico equivalente applicato [N]

Questa relazione vale nelle ipotesi di:

- Temperatura della pista di rotolamento ≤ 100 °C
- Durezza delle piste di rotolamento ≥ 58 HRC
- Assenza di urti e vibrazioni
- Velocità di scorrimento < 15 m/min
- Manicotto singolo su albero, $f_c = 1$
- Flessioni dell'albero nulle

Qualora le condizioni di esercizio non rispettassero le condizioni sopracitate si deve utilizzare la seguente relazione:

$$L = a_1 \times ((f_H \times f_T \times f_c \times f_B \times C) / (f_W \times P))^3 \times 50$$

dove:

- L = durata nominale [km]
- a_1 = fattore di probabilità di cedimento
- f_H = fattore di durezza
- f_T = fattore di temperatura
- f_c = fattore di contatto (vedi coefficiente di sicurezza statico as)
- f_B = coefficiente layout (vedi coefficiente di sicurezza statico as)
- f_W = fattore di carico
- C = capacità di carico dinamica [N]
- P = carico equivalente applicato [N]

Di seguito vengono definiti i fattori a_1 , f_H , f_T , f_W :

Dynamic load

The index used to value the dynamic load capacity for a linear system is:

- Dynamic load rating capacity C

Dynamic load rating capacity C is defined as a dynamic uniform load with constant intensity and direction that allows a nominal life of 50 km prior to the onset of a material breakdown.

Dynamic load rating capacity C is limited by:

- Loads and/or torques applied
- Shaft deformations
- Working speed
- Working cycle.

C values are shown on dimensional tables

Nominal life L

Nominal life L (defined as the life expectancy reached by 90% of the same linear bearing group subjected to equal operating conditions prior to the onset of material breakdown) is defined by the following formula:

where:

- L = nominal life [km]
- C = dynamic load rating capacity [N]
- P = dynamic equivalent load applied [N]

This relation has validity if:

- Shaft temperature ≤ 100 °C
- Shaft hardness ≥ 58 HRC
- No presence of impacts or vibrations
- Working speed < 15 m/min
- One linear bearing for shaft, $f_c = 1$
- No shaft deformations

If these conditions aren't respected, use the following relation:

where:

- L = nominal life [km]
- a_1 = reliability factor
- f_H = hardness factor
- f_T = temperature factor
- f_c = contact factor (see static safety factor as)
- f_B = layout factor (see static safety factor as)
- f_W = load factor
- C = dynamic load rating capacity [N]
- P = dynamic equivalent load applied [N]

Definition of a_1 , f_H , f_T and f_W factors as follows:

Fattore a_1

Il fattore a_1 tiene conto della probabilità di non cedimento C%.

Tabella - Fattore di probabilità di non cedimento a_1

C%	80	85	90	92	95	96	97	98	99
a_1	1.96	1.48	1.00	0.81	0.62	0.53	0.44	0.33	0.21

Si noti che per C% = 90, $a_1 = 1.00$

Fattore di durezza f_H

Una durezza della superficie di contatto inferiore a 58 HRC favorisce il fenomeno dell'usura penalizzando quindi la durata del sistema.

Fattore di durezza f_H Hardness factor f_H

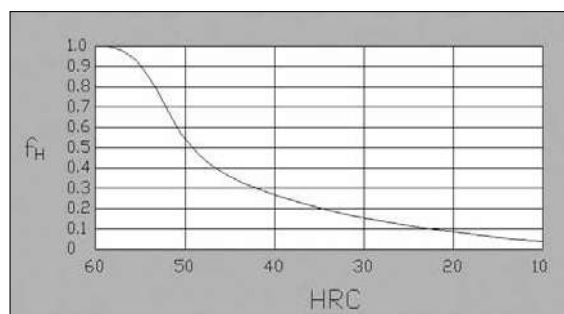

Fattore di temperatura f_T

È necessario conoscere la temperatura dell'elemento durante il funzionamento, poiché un valore superiore a 100°C può modificare le proprietà dei materiali con il conseguente effetto di riduzione della durata. Si consiglia un utilizzo dei sistemi all'interno del range -20°C ÷ 100°C.

Temperature factor f_T

It is important to know the element's working temperature. If it is higher than 100°C, this will change the material's property and consequently reduce the nominal life. We advise to use the systems within the following range: 20°C - 100°C.

Fattore di temperatura f_T Temperature factor f_T

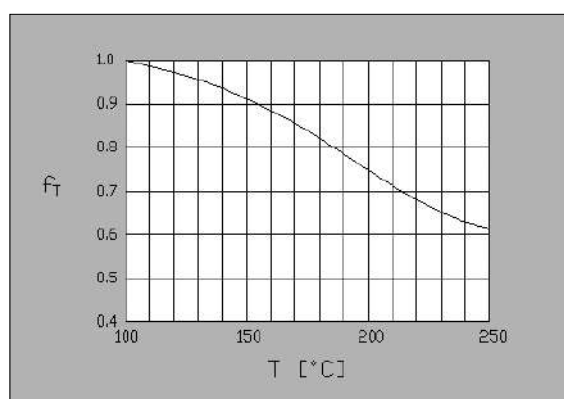



Fattore di carico f_w

Qualora non fosse possibile calcolare con esattezza tutti i carichi dinamici applicati, quali ad esempio forze d'inerzia e relativi momenti generati, vibrazioni ed eventuali urti generati specialmente alle alte velocità, tali fenomeni devono essere considerati tramite questo fattore.

Tabella - Fattore di carico f_w

Condizioni di lavoro <i>Working conditions</i>	f_w
Urti e vibrazioni assenti e/o velocità bassa <i>No impacts, no vibrations and/or slow speed</i> ($v \leq 15$ m/min)	1.0 ÷ 1.5
Urti e vibrazioni leggeri e/o velocità media <i>Light impacts and light vibrations, medium speed</i> ($15 < v < 60$ m/min)	1.5 ÷ 2.0
Urti e vibrazioni forti e/o velocità alta <i>Hard impacts and hard vibrations, high speed</i> ($v \geq 60$ m/min)	2.0 ÷ 3.5

La durata effettiva L_{eff} (o durata di esercizio) può essere differente da quella nominale L calcolata in quanto essa dipende inoltre da:

- Flessioni dell'albero
- Ambiente esterno (presenza di polveri e/o agenti ossidanti)
- Lubrificazione
- Montaggio delle guide (eventuali disallineamenti)
- Precarico

Durata L_h

Conoscendo L (durata nominale in km di percorso) si può ricavare la durata di servizio in ore (L_h).
Essa può essere ricavata in condizioni di:

- Velocità costante
- Velocità variabile

Velocità costante

La durata di servizio in ore L_h è funzione della lunghezza della corsa del manicotto e del numero dei cicli alternativi al minuto; si ricava dalla seguente relazione:

$$L_h = L \times 10^3 / (2 \times l_c \times n_{alt} \times 60)$$

dove:

- L_h = durata di servizio [ore]
- L = durata nominale [km]
- l_c = lunghezza corsa [m]
- n_{alt} = numero cicli alternativi al minuto [min^{-1}]

Load factor f_w

If it weren't possible to calculate all the dynamic applied loads with high accuracy, as for example inertial forces and the generated relative torque, vibrations and impacts especially at high speed, these adjunctive loads have to be considered through this factor.

Table - Load factor f_w

Condizioni di lavoro <i>Working conditions</i>	f_w
Urti e vibrazioni assenti e/o velocità bassa <i>No impacts, no vibrations and/or slow speed</i> ($v \leq 15$ m/min)	1.0 ÷ 1.5
Urti e vibrazioni leggeri e/o velocità media <i>Light impacts and light vibrations, medium speed</i> ($15 < v < 60$ m/min)	1.5 ÷ 2.0
Urti e vibrazioni forti e/o velocità alta <i>Hard impacts and hard vibrations, high speed</i> ($v \geq 60$ m/min)	2.0 ÷ 3.5

Effective life L_{eff} could be different from the nominal L which is also depends on:

- Shaft deformations
- External conditions (presence of dust and/oxidative agents)
- Lubrication
- Shaft mounting (presence of misalignments)
- Preload

Nominal life L_h

*Knowing L (nominal life, calculated in running km) it will be to calculate the same value in hours (L_h).
This can be done when:*

- Uniform speed
- Not uniform speed

Uniform speed

Nominal travel life expressed in hours is function of the travel length and of the number of alternative cycles in a minute; to obtain it, use the following formula:

where:

- L_h = nominal travel life [h]
- L = nominal life [km]
- l_c = travel length [m]
- n_{alt} = number of alternative cycle for minute [min^{-1}]

Velocità variabile

La durata di servizio in ore L_h è funzione della velocità media

$$L_h = L \times 10^3 / (v_m \times 60)$$

dove:

L_h = durata di servizio [ore]

L = durata nominale [km]

v_m = velocità media pari a: $\sum_{i=1}^n v_i \times q_i$ [m/min]

v_i = velocità i-esima [m/min]

q_i = ripartizione i-esima di v_i ($\sum_{i=1}^n q_i = 1$)

Resistenza d'attrito

Il calcolo della resistenza d'attrito S è data dalla seguente relazione:

$$S = \mu \times F + f \times n^\circ \text{ douilles / bushes}$$

dove:

S = resistenza d'attrito (denominata anche forza d'attrito o forza di spinta) [N]

μ = coefficiente d'attrito ($0.002 \leq \mu \leq 0.005$ con $P/C > 0,2$)

F = carico applicato [N]

f = attrito dipendente da: guarnizioni, viscosità del lubrificante, precarico ecc ($2 \leq f \leq 5$ N per singolo manicotto) [N]

n° manicotti = numero manicotti

Lubrificazione

Come tutti i sistemi lineari presenti in commercio, anche i prodotti ISB necessitano di una adeguata lubrificazione per la garanzia della durata prevista; infatti, l'attrito che si genererebbe in assenza di lubrificante sarebbe tale da favorire il fenomeno dell'usura, con la conseguenza di una vita ridotta del sistema. Per la scelta del tipo di lubrificante valgono le seguenti considerazioni di validità generale:

- per velocità medie e corsa orizzontale: grasso a base di sapone di litio 2;
- per velocità sostenute: olio a bassa viscosità;

La scelta ottimale del tipo e della quantità idonea di lubrificante è sempre funzione delle condizioni di lavoro e delle caratteristiche del lubrificante stesso; qualora il sistema lavori in ambiente corrosivo applicare una copertura protettiva aggiuntiva.

Accoppiamento

Le tolleranze di accoppiamento albero-manicotto o albero-supporto sono raffigurate nella tabella seguente:

Not uniform speed

Nominal travel life expressed in hours is function of the average speed

where:

L_h = nominal travel life [h]

L = nominal life [km]

v_m = average speed: $\sum_{i=1}^n v_i \times q_i$ [m/min]

v_i = i-part speed [m/min]

q_i = i-part portion of v_i ($\sum_{i=1}^n q_i = 1$)

Friction resistance

The friction resistance S is given by the following relation:

where:

S = friction resistance (named friction force or push force) [N]

μ = friction coefficient ($0.002 \leq \mu \leq 0.005$ with $P/C > 0,2$);

F = load applied [N]

f = friction function of: seals, lubricant, preload etc ($2 \leq f \leq 5$ N for each bush) [N]

n° bushes = number of bushes

Lubrication

As all linear systems, ISB linear system products need an adequate lubrication too as guarantee the calculated life; in fact, without the necessary lubrication there would be a significant reduction of nominal life caused by the wear and tear phenomenon. To choose the right lubricant use the following general indications:

- for median speed and horizontal travel: soap lithium greases 2;
- for high speed: oil with low viscosity.

The optimal choice of lubricant and its quantity is always function of the work conditions and of its characteristics; if the external ambient is corrosive, use an adjunctive protection.

Coupling

The following table gives the fitting shaft-bush tolerances:

Tabella - Gioco di funzionamento di cuscinetti KH
Table - Working clearance of KH bearings

Materiale dell'alloggiamento <i>Housing material</i>	Acciaio o ghisa <i>Steel or cast iron</i>	Metallo leggero <i>Light metal</i>
Gioco di funzionamento normale / Standard working clearance		
Tolleranza foro / <i>Bore tolerance</i>	H7	K7
Tolleranza albero / <i>Shaft tolerance</i>	h6	h6
Jeu de fonctionnement inférieur au normal / Working clearance under standard level		
Tolleranza foro / <i>Bore tolerance</i>	H6	K6
Tolleranza albero / <i>Shaft tolerance</i>	j5	j5

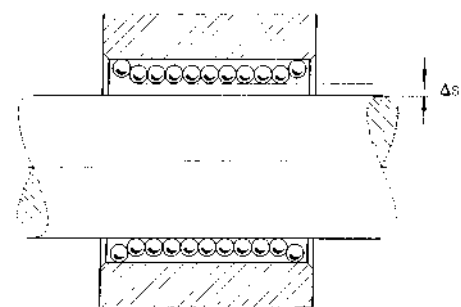

Gioco di funzionamento / Working clearance

Tabella - Gioco di funzionamento di cuscinetti KB / Table - Working clearance of KB bearings

Tolleranze di montaggio / <i>Mounting tolerances</i>		Cuscinetto <i>Bearing</i>	Gioco di funzionamento (dimensioni) <i>Working clearance (dimensions)</i>
Albero/ <i>Shaft</i>	Foro/ <i>Bore</i>		
h6	H6 (H7)	KB 1232	+19 -1
h6	H6 (H7)	KB 1636	+19 -1
h6	H6 (H7)	KB 2045	+22 -1
h6	H6 (H7)	KB 2558	+24 -1
h6	H6 (H7)	KB 3068	+24 -1
h6	H6 (H7)	KB 4080	+29 -2
h6	H6 (H7)	KB 50100	+29 -2

Tabella - Gioco di funzionamento di cuscinetti a sfere per movimenti lineari KBS, KBO
Table - Working clearance of ball bearings for KBS and KBO linear movements

Tolleranze di montaggio <i>Mounting tolerances</i>		Gioco di funzionamento <i>Working clearance</i>						
Albero <i>Shaft</i>	Foro <i>Bore</i>	KBS 1232	KBS 1636	KBS 2045	KBS 2558	KBS 3068	KBS 4080	KBS 50100
		KBO 1232	KBO 1636	KBO 2045	KBO 2558	KBO 3068	KBO 4080	KBO 50100
h6	H6	+37	+37	+43	+44	+44	+51	+51
		+16	+16	+17	+18	+18	+20	+20
h6	JS6	+30	+31	+35	+36	+36	+42	+42
		+9	+9	+9	+10	+10	+10	+10
h6	K6	+26	+26	+30	+31	+31	+36	+36
		+5	+5	+5	+5	+5	+5	+5
h6	M6	+20	+20	+23	+24	+24	+27	+27
		-1	-1	-2	-2	-2	-4	-4

Per evitare fenomeni di deterioramento precoce, nella fase di montaggio del manicotto nel relativo supporto, si utilizzi un tampone cilindrico avente un diametro esterno inferiore di 0.1 mm del diametro esterno del manicotto, con superficie d'appoggio piana e perpendicolare all'asse (vedi figura).

To avoid early deterioration during the mounting of the bush in the corresponding support, use a cylindrical buffer whose bottom external diameter is 0.1 mm less wide than the bush's external diameter. The buffer should be provided with a plane and perpendicular push surface (see the picture).

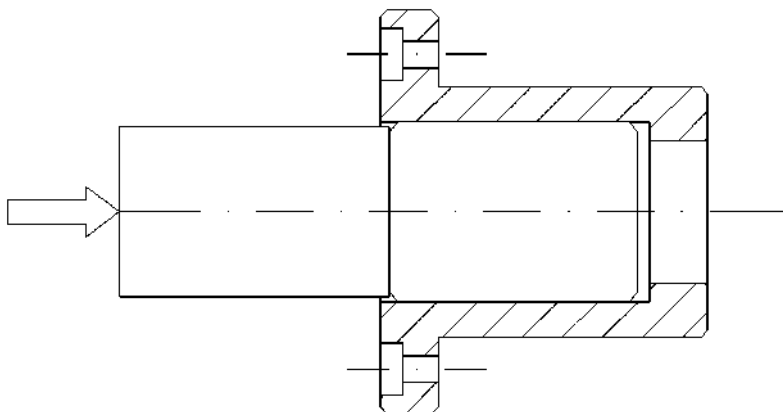

Qualora l'accoppiamento fosse libero, cioè privo di interferenze, si utilizzino ghiera, anelli elastici, coperchi ecc. per il bloccaggio dell'elemento.

E' tuttavia necessario tenere presente che il buon funzionamento di un cuscinetto per la movimentazione lineare è legato ai seguenti fattori:

- **montaggio:** deve essere accurato e senza urti sull'elemento; la forza d'inserimento deve essere il più possibile costante e agente sul bordo esterno;
- **lubrificazione:** adatta al tipo di utilizzo, deve considerare lubrificanti di buona qualità;
- **dimensionamento:** i carichi agenti devono essere ben sopportati dall'elemento;
- **ambiente esterno:** non ci deve essere la possibilità che polveri e particelle meccaniche vengano inglobate nei ricircoli si sfere.

If there is a free mounting (without interferences), use lock nuts, elastic rings, covers etc. to lock the element.

It's important to know that the right working conditions are determined by:

- **mounting:** it has to be accurate without impacts; the push force has to be constant and applied on the external rim;
- **lubrication:** chosen according to the working conditions, it has to consider good quality lubricants;
- **dimensions:** the applied loads have to be accurately calculated;
- **external environment:** dust and other materials must not be swallowed by ball recirculates.

Manicotti a sfere

I prodotti ISB per la movimentazione lineare su albero sono stati ideati per offrire buone prestazioni mantenendo un minimo coefficiente di attrito. Il loro impiego trova applicazione in svariati campi, quali parti mobili di macchine confezionatrici, macchine utensili, macchine per la lavorazione dell'alluminio e del legno, sistemi di protezione e copertura, robots, sistemi di posizionamento e strumentazioni di misura e controllo.



I manicotti a ricircolo di sfere ISB si suddividono in:

Serie leggera (KH)

I manicotti a sfere ISB serie leggera presentano i seguenti vantaggi:

- ingombri radiali minimi

Serie normale:

I manicotti a sfere ISB serie normale presentano i seguenti vantaggi:

- buona rigidità
 - basso coefficiente di attrito
 - elevata precisione
 - elevata silenziosità d'esercizio
- non flangiati (KB, KBS, KBO, KBL)
flangiati (KBF, KBFL, KBK, KBKL, KBH, KBHL)

• Serie autoallineante (KN, KNO)

I manicotti a sfere ISB serie autoallineante, presentano i seguenti vantaggi:

- compensazione di disallineamenti fino a $\pm 30'$
- maggiore capacità di carico e quindi maggiore durata
- velocità ammissibile aumentata
- elevata silenziosità d'esercizio

Tutti possono essere forniti con:

- anelli di tenuta in entrambi i lati (suffisso -PP)
- senza anelli di tenuta (nessun suffisso)

Slide bushes

ISB linear bearings have been made to offer a good performance by keeping a minimum friction coefficient. They apply to different sectors, such as package machines, tool machines, wood and aluminium working machines, protection and covering systems, robots, positioning systems and measurement instruments too.

ISB bushes are divided into:

Light series (KH);

ISB light bushes series has the following advantages:

- smallest overall radial dimensions

Normal series:

ISB normal bushes series has the following advantages:

- good rigidity
 - low friction coefficient
 - high precision
 - high work-noiselessness
- not flanged (KB, KBS, KBO, KBL)
flanged (KBF, KBFL, KBK, KBKL, KBH, KBHL)

• Self-alignment series (KN, KNO)

ISB slide bushes self-alignment series, has the following advantages:

- misalignment compensation until $\pm 30'$
- higher load capacity and therefore higher nominal life
- higher admissible speed
- high work-noiselessness

They can be supplied with:

- seals on both sides (suffix -PP)
- without seals (no suffix)

**Intercambiabilità / Interchangeability****Serie KH/ KH series**

ISB	INA	FAG	SKF	STAR	NTN	KBS
KH..	KH..	LNA..	LBBR..	0658-0..-00	KH..	KH..
	(LBBS..)	(LFA..)				
KH..PP	KH..PP	LNA..2RS	LBBR..2LS	0658-2..-40	KH..LL	KH.PP
	(LBBS..2LS)	(LFA..2RS)				

Gabbia in poliammide / Polyamide cage**Serie KB / KB series**

ISB	INA	SKF	KBS	NB	THK	IKO	THOMSON	EASE
KB..	KB..	LBAR/LBCR..	LME..	KB..G	LME..	LBE..	MA M..	SDE..
KB..PP	KB..PP	LBAR/LBCR..2LS	LME..UU	KB..GUU	LME..UU	LBE..UU	MA M..WW	SDE..UU
KBS..	KBS..	LBAS..	LME..AJ	KB..GAJ	LME..AJ	LBE..AJ	MA M..ADJ	SDE..AJ
KBS..PP	KBS..PP	LBAS..2LS	LME..UUAJ	KB..GUUAJ	LME..UUAJ	LBE..UUAJ	MA M..ADJ WW	SDE..UUAJ
KBO..	KBO..	LBAT/LBCT..	LME..OP	KB..GOP	LME..OP	LBE..OP	MA M..OPN	SDE..OP
KBO..PP	KBO..PP	LBAT/LBCT..2LS	LME..UUOP	KB..GUUOP	LME..UUOP	LBE..UUOP	MA M..OPN WW	SDE..UUOP



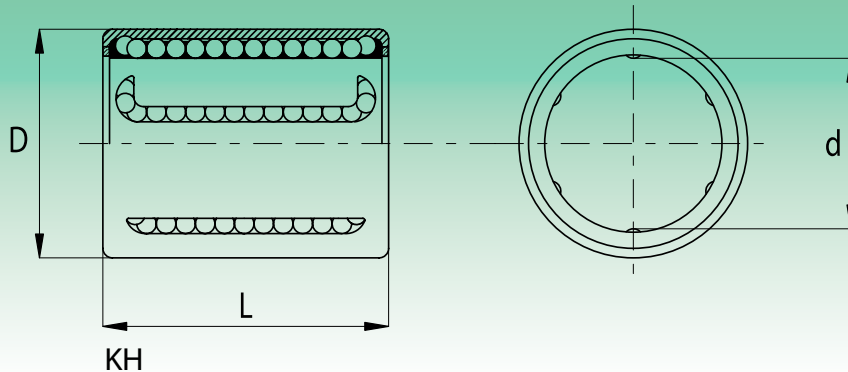
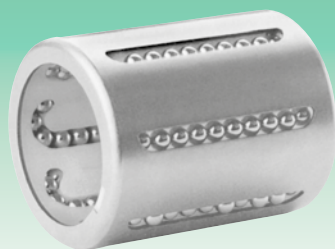

Tipologia Type	Peso Weight [kg]	d [mm]	D [mm]	L [mm]	Capacità di Carico Load capacity rating [N]	
					C	C ₀
KH 06 22	0.007	6	12	22	400	239
KH 08 24	0.013	8	15	24	435	280
KH 10 26	0.015	10	17	26	500	370
KH 12 28	0.019	12	19	28	620	510
KH 14 28	0.021	14	21	28	620	520
KH 16 30	0.028	16	24	30	800	620
KH 20 30	0.033	20	28	30	950	790
KH 25 40	0.066	25	35	40	1990	1670
KH 30 50	0.095	30	40	50	2800	2700
KH 40 60	0.182	40	52	60	4400	4450
KH 50 70	0.252	50	62	70	5500	6300

Sigla d'ordine/Specification number: KH - d - PP [tenute in entrambi i lati / seals on both sides].
 Sigla d'ordine/Specification number: KH - d [senza tenute / without seals].

Esempio: KH 16 PP (modello KH, diametro albero 16 mm, tenute in entrambi i lati).
 Example: KH 16 PP (model KH, shaft diameter 16 mm, seals on both sides).

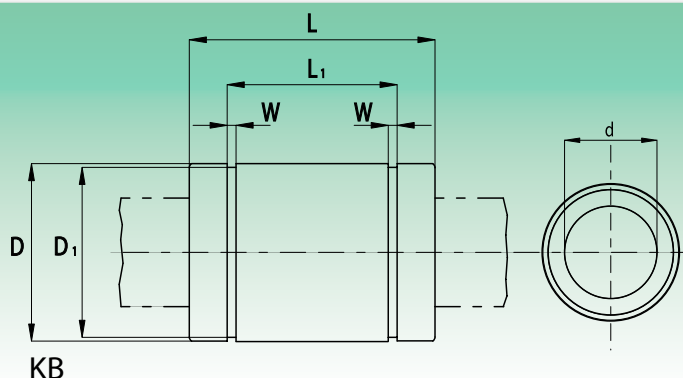
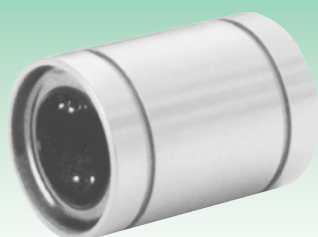
Manicotti a sfere serie pesante (KB)
Slide bushes heavy series (KB)

KB

KB = Gabbia in poliammide - *Polyamide cage*

Tipologia Type	N° ricircoli Number of ball rows	Peso Weight [kg]	d [mm]	d Tolleranza Tolerance [μm]	D [mm]	D Tolleranza Tolerance [μm]	L [mm]	L Tolleranza Tolerance [mm]
KB 05 22	4	0.012	5	+8 ÷ 0	12	0 ÷ -8	22	0 ÷ -0.2
KB 08 25	4	0.018	8	+8 ÷ 0	16	0 ÷ -8	25	0 ÷ -0.2
KB 10 29	4	0.024	10	+8 ÷ 0	19	0 ÷ -8	29	0 ÷ -0.2
KB 12 32	4	0.041	12	+8 ÷ 0	22	0 ÷ -9	32	0 ÷ -0.2
KB 16 36	5	0.055	16	+9 ÷ -1	26	0 ÷ -9	36	0 ÷ -0.2
KB 20 45	5	0.091	20	+9 ÷ -1	32	0 ÷ -11	45	0 ÷ -0.2
KB 25 58	6	0.205	25	+11 ÷ -1	40	0 ÷ -11	58	0 ÷ -0.3
KB 30 68	6	0.310	30	+11 ÷ -1	47	0 ÷ -11	68	0 ÷ -0.3
KB 40 80	6	0.680	40	+13 ÷ -2	62	0 ÷ -13	80	0 ÷ -0.3
KB 50 100	6	1.030	50	+13 ÷ -2	75	0 ÷ -13	100	0 ÷ -0.3
KB 60 125	6	2.010	60	+13 ÷ -2	90	0 ÷ -15	125	0 ÷ -0.4

Tipologia Type	L ₁ [mm]	L ₁ Tolleranza Tolerance [mm]	W [mm]	D ₁ [mm]	Eccentricità max Max eccentricity [μm]	Tolleranza gioco radiale Radial clearance tolerance [μm]	Capacità di Carico Load capacity rating [N]	
							C	C ₀
KB 05 22	14.5	0 ÷ -0.2	1.1	11.5	12	-5	210	270
KB 08 25	16.5	0 ÷ -0.2	1.1	15.2	12	-5	270	410
KB 10 29	22	0 ÷ -0.2	1.3	18	12	-5	370	470
KB 12 32	22.9	0 ÷ -0.2	1.3	21	12	-7	520	790
KB 16 36	24.9	0 ÷ -0.2	1.3	24.9	12	-7	590	910
KB 20 45	31.5	0 ÷ -0.2	1.6	30.3	15	-9	880	1400
KB 25 58	44.1	0 ÷ -0.3	1.85	37.5	15	-9	1000	1600
KB 30 68	52.1	0 ÷ -0.3	1.85	44.5	15	-9	1600	2800
KB 40 80	60.6	0 ÷ -0.3	2.15	59	17	-13	2200	4000
KB 50 100	77.6	0 ÷ -0.3	2.65	72	17	-13	3900	8100
KB 60 125	101.7	0 ÷ -0.4	3.15	86.5	20	-16	4800	10200

Sigla d'ordine/Specification number: KB – d – PP [tenute in entrambi i lati / seals on both sides].
 Sigla d'ordine/Specification number: KB – d [senza tenute / without seals].

Esempio: KB 20 PP (modello KB, diametro albero 20 mm, tenute in entrambi i lati).
 Example: KB 20 PP (KB model, shaft diameter 20 mm, seals on both sides).

Su richiesta sono disponibili anche con gabbia in acciaio.
 Under request are available, also with steel cage.

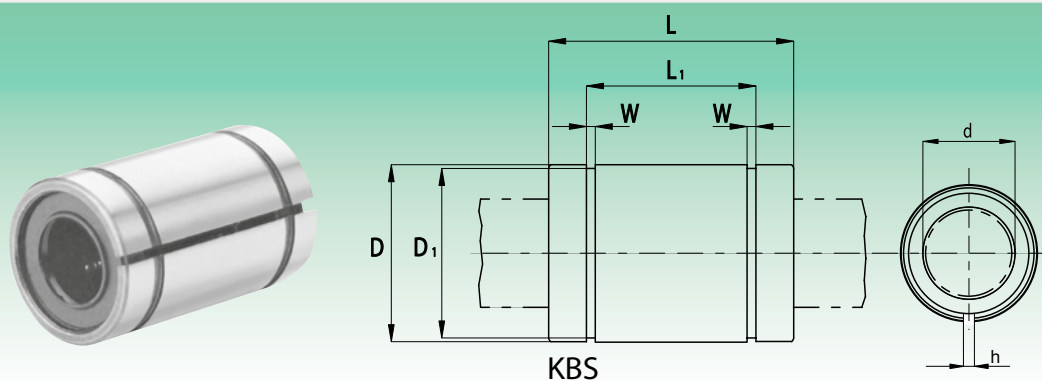

KBS = Gabbia in poliammide - Polyamide cage

Tipologia Type	N° ricircoli Number of ball rows	Peso Weight [kg]	d [mm]	d Tolleranza Tolerance [μm]	D [mm]	D Tolleranza Tolerance [μm]	L [mm]	L Tolleranza Tolerance [mm]
KBS 05 22	4	0.012	5	+8 ÷ 0	12	0 ÷ -8	22	0 ÷ -0.2
KBS 08 25	4	0.018	8	+8 ÷ 0	16	0 ÷ -8	25	0 ÷ -0.2
KBS 10 29	4	0.024	10	+8 ÷ 0	19	0 ÷ -8	29	0 ÷ -0.2
KBS 12 32	4	0.041	12	+8 ÷ 0	22	0 ÷ -9	32	0 ÷ -0.2
KBS 16 36	5	0.055	16	+9 ÷ -1	26	0 ÷ -9	36	0 ÷ -0.2
KBS 20 45	5	0.091	20	+9 ÷ -1	32	0 ÷ -11	45	0 ÷ -0.2
KBS 25 58	6	0.205	25	+11 ÷ -1	40	0 ÷ -11	58	0 ÷ -0.3
KBS 30 68	6	0.310	30	+11 ÷ -1	47	0 ÷ -11	68	0 ÷ -0.3
KBS 40 80	6	0.680	40	+13 ÷ -2	62	0 ÷ -13	80	0 ÷ -0.3
KBS 50 100	6	1.030	50	+13 ÷ -2	75	0 ÷ -13	100	0 ÷ -0.3
KBS 60 125	6	2.010	60	+13 ÷ -2	90	0 ÷ -15	125	0 ÷ -0.4

Tipologia Type	L ₁ [mm]	L ₁ Tolleranza Tolerance [mm]	W [mm]	h [mm]	D ₁ [mm]	Eccentricità max Max eccentricity [μm]	Tolleranza gioco radiale Radial clearance tolerance [μm]	Capacità di Carico Load capacity rating [N]	
								C	C ₀
KBS 05 22	14.5	0 ÷ -0.2	1.1	1.1	11.5	12	-5	210	270
KBS 08 25	16.5	0 ÷ -0.2	1.1	1.1	15.2	12	-5	270	410
KBS 10 29	22	0 ÷ -0.2	1.3	1.3	18	12	-5	370	470
KBS 12 32	22.9	0 ÷ -0.2	1.3	1.3	21	12	-7	520	790
KBS 16 36	24.9	0 ÷ -0.2	1.3	1.3	24.9	12	-7	590	910
KBS 20 45	31.5	0 ÷ -0.2	1.6	1.6	30.3	15	-9	880	1400
KBS 25 58	44.1	0 ÷ -0.3	1.85	1.85	37.5	15	-9	1000	1600
KBS 30 68	52.1	0 ÷ -0.3	1.85	1.85	44.5	15	-9	1600	2800
KBS 40 80	60.6	0 ÷ -0.3	2.15	2.15	59	17	-13	2200	4000
KBS 50 100	77.6	0 ÷ -0.3	2.65	2.65	72	17	-13	3900	8100
KBS 60 125	101.7	0 ÷ -0.4	3.15	3.15	86.5	20	-16	4800	10200

Sigla d'ordine/Specification number: KBS – d – PP [tenute in entrambi i lati / seals on both sides].
 Sigla d'ordine/Specification number: KBS – d [senza tenute / without seals].

Esempio: KBS 20 PP (modello KBS, diametro albero 20 mm, tenute in entrambi i lati).
 Example: KBS 20 PP (KBS model, shaft diameter 20 mm, seals on both sides).

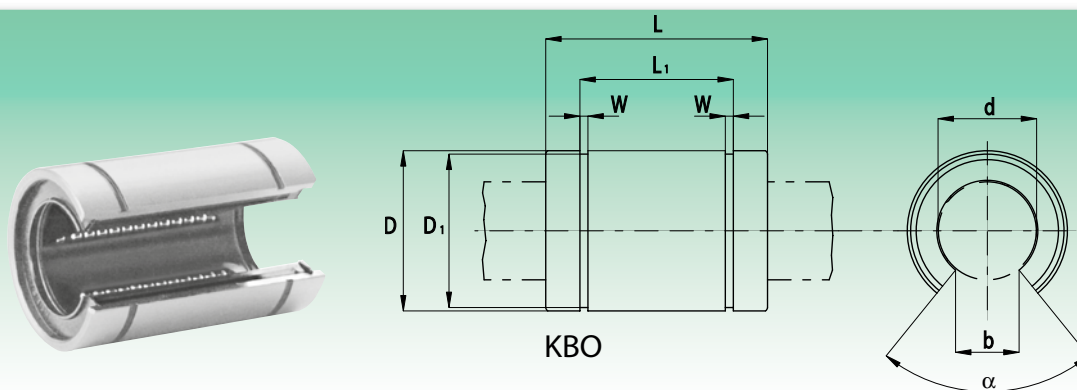
Manicotti a sfere serie pesante aperti (KBO)
Slide bushes, heavy series open (KBO)

KBO = Gabbia in poliammide - *Polyamide cage*

Tipologia Type	N° ricircoli Number of ball rows	Peso Weight [kg]	d [mm]	d Tolleranza Tolerance [μm]	D [mm]	D Tolleranza Tolerance [μm]	L [mm]	L Tolleranza Tolerance [mm]
KBO 10 29	3	0.025	10	0 ÷ +8	19	0 ÷ -9	29	0 ÷ -0.2
KBO 12 32	3	0.029	12	0 ÷ +8	22	0 ÷ -9	32	0 ÷ -0.2
KBO 16 36	4	0.044	16	+9 ÷ -1	26	0 ÷ -9	36	0 ÷ -0.2
KBO 20 45	4	0.080	20	+9 ÷ -1	32	0 ÷ -11	45	0 ÷ -0.2
KBO 25 58	5	0.170	25	+11 ÷ -1	40	0 ÷ -11	58	0 ÷ -0.3
KBO 30 68	5	0.260	30	+11 ÷ -1	47	0 ÷ -11	68	0 ÷ -0.3
KBO 40 80	5	0.590	40	+13 ÷ -2	62	0 ÷ -13	80	0 ÷ -0.3
KBO 50 100	5	0.900	50	+13 ÷ -2	75	0 ÷ -13	100	0 ÷ -0.3
KBO 60 125	5	1.700	60	+13 ÷ -2	90	0 ÷ -15	125	0 ÷ -0.4

Tipologia Type	L ₁ [mm]	L ₁ Tolleranza Tolerance [mm]	W [mm]	b [mm]	α	D ₁ [mm]	Eccentricità max Max eccentricity [μm]	Tolleranza gioco radiale Radial clearance tolerance [μm]	Capacità di Carico Load capacity rating [N]	
									C	C ₀
KBO 10 29	22	0 ÷ -0.2	1.3	6.8	80°	18	12	-	380	560
KBO 12 32	22.9	0 ÷ -0.2	1.3	7.5	78°	21	12	-	520	790
KBO 16 36	24.9	0 ÷ -0.2	1.3	10	78°	24.9	12	-7	590	910
KBO 20 45	31.5	0 ÷ -0.2	1.6	10	60°	30.3	15	-9	880	1400
KBO 25 58	44.1	0 ÷ -0.3	1.85	12.5	60°	37.5	15	-9	1000	1600
KBO 30 68	52.1	0 ÷ -0.3	1.85	12.5	50°	44.5	15	-9	1600	2800
KBO 40 80	60.6	0 ÷ -0.3	2.15	16.8	50°	59	17	-13	2200	4000
KBO 50 100	77.6	0 ÷ -0.3	2.65	21	50°	72	17	-13	3900	8100
KBO 60 125	101.7	0 ÷ -0.4	3.15	27.2	54°	86.5	20	-16	4800	10200

Sigla d'ordine/Specification number: KBO – d – PP [tenute in entrambi i lati / seals on both sides].
 Sigla d'ordine/Specification number: KBO – d [senza tenute / without seals].

Esempio: KBO 20 PP (modello KBO, diametro albero 20 mm, tenute in entrambi i lati).
 Example: KBO 20 PP (KBO model, shaft diameter 20 mm, seals on both sides).

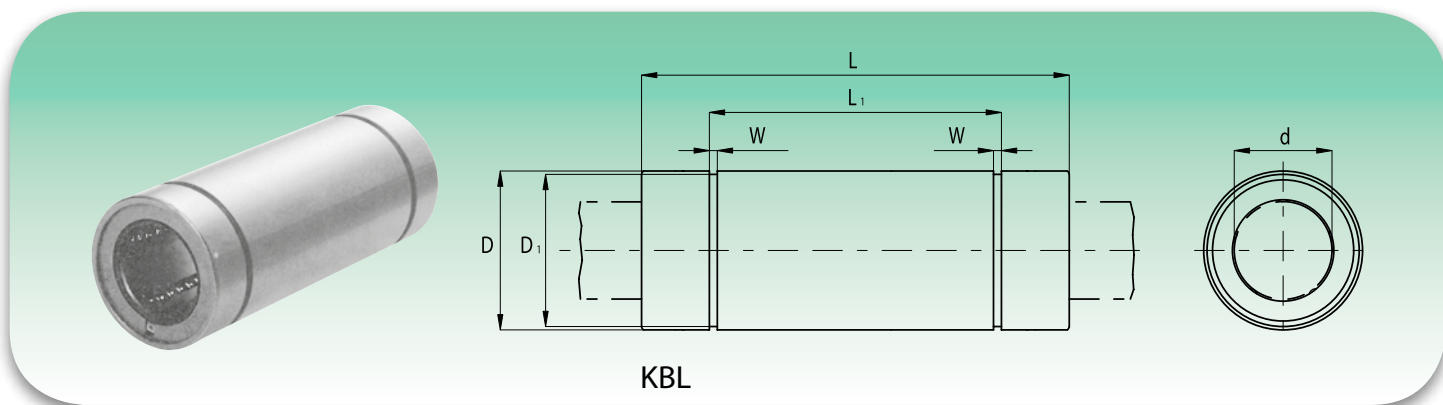

KBL

KBL = Gabbia in poliammide - Polyamide cage

Tipologia Type	N° ricircoli Number of ball rows	Peso Weight [kg]	d [mm]	d Tolleranza Tolerance [μm]	D [mm]	D Tolleranza Tolerance [μm]	L [mm]	L Tolleranza Tolerance [mm]
KBL 08 45	4	0.031	8	+9 ÷ -1	16	0 ÷ -9	45	0 ÷ -0.3
KBL 12 57	4	0.080	12	+9 ÷ -1	22	0 ÷ -11	57	0 ÷ -0.3
KBL 16 70	5	0.145	16	+11 ÷ -1	26	0 ÷ -11	70	0 ÷ -0.3
KBL 20 80	5	0.180	20	+11 ÷ -1	32	0 ÷ -13	80	0 ÷ -0.3
KBL 25 112	6	0.440	25	+13 ÷ -2	40	0 ÷ -13	112	0 ÷ -0.4
KBL 30 123	6	0.580	30	+13 ÷ -2	47	0 ÷ -13	123	0 ÷ -0.4
KBL 40 154	6	1.170	40	+16 ÷ -4	62	0 ÷ -15	154	0 ÷ -0.4
KBL 50 192	6	3.000	50	+16 ÷ -4	75	0 ÷ -15	192	0 ÷ -0.4
KBL 60 211	6	3.500	60	+16 ÷ -4	90	0 ÷ -20	209	0 ÷ -0.4

Tipologia Type	L ₁ [mm]	L ₁ Tolleranza Tolerance [mm]	W [mm]	D ₁ [mm]	Eccentricità max Max eccentricity [μm]	Tolleranza gioco radiale Radial clearance tolerance [μm]	Capacità di Carico Load capacity rating [N]	
							C	C ₀
KBL 08 45	33	0 ÷ -0.3	1.1	15.2	15	-15	431	784
KBL 12 57	45.8	0 ÷ -0.3	1.3	21	15	-15	657	1200
KBL 16 70	49.8	0 ÷ -0.3	1.3	24.9	15	-15	1230	2350
KBL 20 80	61	0 ÷ -0.3	1.6	30.5	15	-15	1400	2750
KBL 25 112	82	0 ÷ -0.4	1.85	38	17	-17	1560	3140
KBL 30 123	104.2	0 ÷ -0.4	1.85	44.5	17	-17	2490	5490
KBL 40 154	121.2	0 ÷ -0.4	2.15	59	20	-20	3430	8040
KBL 50 192	155.2	0 ÷ -0.4	2.65	72	20	-20	6080	15900
KBL 60 211	170	0 ÷ -0.4	3.15	86.5	25	-25	7650	20000

Sigla d'ordine/Specification number: KBL - d - PP [tenute in entrambi i lati / seals on both sides].

Sigla d'ordine/Specification number: KBL - d [senza tenute / without seals].

Esempio: KBL 20 PP (modello KBL, diametro albero 20 mm, tenute in entrambi i lati).

Example: KBL 20 PP (KBL model, shaft diameter 20 mm, seals on both sides).

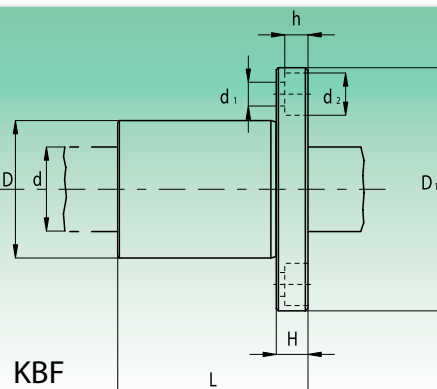
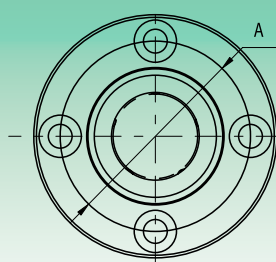
Manicotti a sfere serie pesante flangia tonda (KBF)
Slide bushes, heavy series round flanged (KBF)

KBF = Gabbia in poliammide - *Polyamide cage*

Tipologia Type	N° ricircoli Number of ball rows	Peso Weight [kg]	d [mm]	d Tolleranza Tolerance [μm]	D [mm]	D Tolleranza Tolerance [μm]	L [mm]	L Tolleranza Tolerance [mm]	D1 [mm]	D1 Tolleranza Tolerance [mm]
KBF 08	4	0.044	8	+8 ÷ 0	16	0 ÷ -8	25	0 ÷ -0.2	32	0 ÷ -0.2
KBF 12	4	0.086	12	+8 ÷ 0	22	0 ÷ -9	32	0 ÷ -0.2	42	0 ÷ -0.2
KBF 16	5	0.120	16	+9 ÷ -1	26	0 ÷ -9	36	0 ÷ -0.2	46	0 ÷ -0.2
KBF 20	5	0.184	20	+9 ÷ -1	32	0 ÷ -11	45	0 ÷ -0.2	54	0 ÷ -0.2
KBF 25	6	0.335	25	+11 ÷ -1	40	0 ÷ -11	58	0 ÷ -0.3	62	0 ÷ -0.2
KBF 30	6	0.545	30	+11 ÷ -1	47	0 ÷ -11	68	0 ÷ -0.3	76	0 ÷ -0.2
KBF 40	6	1.180	40	+13 ÷ -2	62	0 ÷ -13	80	0 ÷ -0.3	98	0 ÷ -0.3
KBF 50	6	1.730	50	+13 ÷ -2	75	0 ÷ -13	100	0 ÷ -0.3	112	0 ÷ -0.3
KBF 60	6	3.180	60	+13 ÷ -2	90	0 ÷ -15	125	0 ÷ -0.4	134	0 ÷ -0.3

Tipologia Type	H [mm]	A [mm]	d1xd2xh [mm]	Tolleranza perpendicolarità flangia Perpendicularity flange tolerance [μm]	Eccentricità max Max eccentricity [μm]	Tolleranza gioco radiale Radial clearance tolerance [μm]	Capacità di Carico Load capacity rating [N]	
							C	C ₀
KBF 08	5	24	3.4 x 6.5 x 3.3	12	12	-5	270	410
KBF 12	6	32	4.5 x 8 x 4.4	12	12	-5	520	790
KBF 16	6	36	4.5 x 8 x 4.4	12	12	-7	590	910
KBF 20	8	43	5.5 x 9.5 x 5.4	15	15	-9	880	1400
KBF 25	8	51	5.5 x 9.5 x 5.4	15	15	-9	1000	1600
KBF 30	10	62	6.6 x 11 x 6.5	15	15	-9	1600	2800
KBF 40	13	80	9 x 14 x 8.6	20	20	-13	2200	4100
KBF 50	13	94	9 x 14 x 8.6	20	20	-13	3900	8100
KBF 60	18	112	11 x 17.5 x 10.8	25	25	-13	4800	10200

Sigla d'ordine/Specification number: KBF - d - PP [tenute in entrambi i lati / seals on both sides].

Sigla d'ordine/Specification number: KBF - d [senza tenute / without seals].

Esempio: KBF 20 PP (modello KBF, diametro albero 20 mm, tenute in entrambi i lati).

Example: KBF 20 PP (KBF model, shaft diameter 20 mm, seals on both sides).

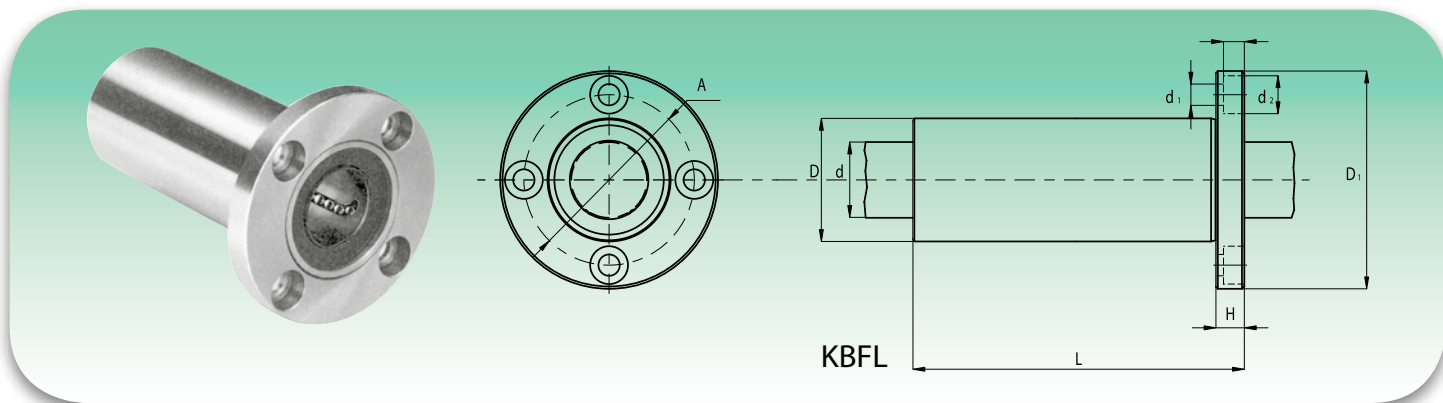

KBFL = Gabbia in poliammide - *Polyamide cage*

Tipologia Type	N° ricircoli Number of ball rows	Peso Weight [kg]	d [mm]	d Tolleranza Tolerance [μm]	D [mm]	D Tolleranza Tolerance [μm]	L [mm]	L Tolleranza Tolerance [mm]	D1 [mm]	D1 Tolleranza Tolerance [mm]
KBFL 08	4	0.053	8	+9 ÷ -1	16	0 ÷ -9	45	0 ÷ -0.3	32	0 ÷ -0.2
KBFL 12	4	0.100	12	+9 ÷ -1	22	0 ÷ -11	57	0 ÷ -0.3	42	0 ÷ -0.2
KBFL 16	5	0.187	16	+11 ÷ -1	26	0 ÷ -11	70	0 ÷ -0.3	46	0 ÷ -0.2
KBFL 20	5	0.260	20	+11 ÷ -1	32	0 ÷ -13	80	0 ÷ -0.3	54	0 ÷ -0.2
KBFL 25	6	0.550	25	+13 ÷ -2	40	0 ÷ -13	112	0 ÷ -0.4	62	0 ÷ -0.2
KBFL 30	6	0.650	30	+13 ÷ -2	47	0 ÷ -13	123	0 ÷ -0.4	76	0 ÷ -0.2
KBFL 40	6	1.560	40	+16 ÷ -4	62	0 ÷ -15	154	0 ÷ -0.4	98	0 ÷ -0.3
KBFL 50	6	3.500	50	+16 ÷ -4	75	0 ÷ -15	192	0 ÷ -0.4	112	0 ÷ -0.3
KBFL 60	6	4.500	60	+16 ÷ -4	90	0 ÷ -20	209	0 ÷ -0.4	134	0 ÷ -0.3

Tipologia Type	H [mm]	A [mm]	d1xd2xh [mm]	Tolleranza perpendicolarità flangia Perpendicularity flange tolerance [μm]	Eccentricità max Max eccentricity [μm]	Tolleranza gioco radiale Radial clearance tolerance [μm]	Capacità di Carico Load capacity rating [N]	
							C	C ₀
KBFL 08	5	24	3.4 x 6.5 x 3.3	12	12	-5	431	784
KBFL 12	6	32	4.5 x 8 x 4.4	12	12	-5	657	1200
KBFL 16	6	36	4.5 x 8 x 4.4	12	12	-7	1230	2350
KBFL 20	8	43	5.5 x 9.5 x 5.4	15	15	-9	1400	2750
KBFL 25	8	51	5.5 x 9.5 x 5.4	15	15	-9	1560	3140
KBFL 30	10	62	6.6 x 11 x 6.5	15	15	-9	2490	5490
KBFL 40	13	80	9 x 14 x 8.6	20	20	-13	3430	8040
KBFL 50	13	94	9 x 14 x 8.6	20	20	-13	6080	15900
KBFL 60	18	112	11 x 17.5 x 10.8	25	25	-13	7650	20000

Sigla d'ordine/Specification number:

KBFL – d – PP

[tenute in entrambi i lati / seals on both sides].

Sigla d'ordine/Specification number:

KBFL – d

[senza tenute / without seals].

Esempio: KBFL 20 PP (modello KBFL, diametro albero 20 mm, tenute in entrambi i lati).

Example: KBFL 20 PP (KBFL model, shaft diameter 20 mm, seals on both sides).

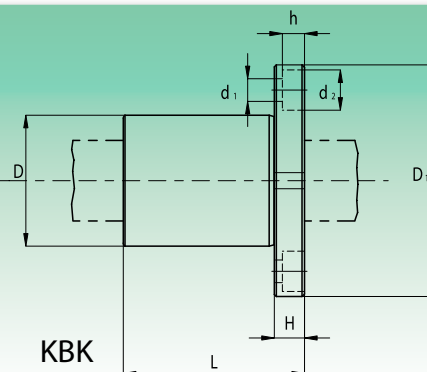
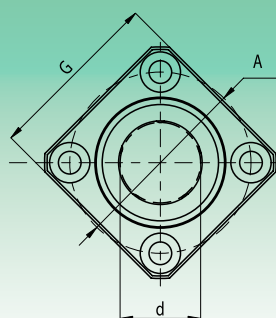
Manicotti a sfere serie pesante flangia quadrata (KBK)
Slide bushes, heavy series square flanged (KBK)

KBK = Gabbia in poliammide - *Polyamide cage*

Tipologia Type	N° ricircoli Number of ball rows	Peso Weight [kg]	d [mm]	d Tolleranza Tolerance [μm]	D [mm]	D Tolleranza Tolerance [μm]	L [mm]	L Tolleranza Tolerance [mm]	D1 [mm]	D1 Tolleranza Tolerance [mm]
KBK 08	4	0.033	8	+8 ÷ 0	16	0 ÷ -8	25	0 ÷ -0.2	32	0 ÷ -0.2
KBK 12	4	0.066	12	+8 ÷ 0	22	0 ÷ -9	32	0 ÷ -0.2	42	0 ÷ -0.2
KBK 16	5	0.090	16	+9 ÷ -1	26	0 ÷ -9	36	0 ÷ -0.2	46	0 ÷ -0.2
KBK 20	5	0.149	20	+9 ÷ -1	32	0 ÷ -11	45	0 ÷ -0.2	54	0 ÷ -0.2
KBK 25	6	0.295	25	+11 ÷ -1	40	0 ÷ -11	58	0 ÷ -0.3	62	0 ÷ -0.2
KBK 30	6	0.460	30	+11 ÷ -1	47	0 ÷ -11	68	0 ÷ -0.3	76	0 ÷ -0.2
KBK 40	6	0.995	40	+13 ÷ -2	62	0 ÷ -13	80	0 ÷ -0.3	98	0 ÷ -0.3
KBK 50	6	1.550	50	+13 ÷ -2	75	0 ÷ -13	100	0 ÷ -0.3	112	0 ÷ -0.3
KBK 60	6	2.740	60	+13 ÷ -2	90	0 ÷ -15	125	0 ÷ -0.4	134	0 ÷ -0.3

Tipologia Type	G [mm]	H [mm]	A [mm]	d1xd2xh [mm]	Tolleranza perpendicolarità flangia Perpendicularity flange tolerance [μm]	Eccentricità max Max eccentricity [μm]	Tolleranza gioco radiale Radial clearance tolerance [μm]	Capacità di Carico Load capacity rating [N]	
								C	C ₀
KBK 08	25	5	24	3.4 x 6.5 x 3.3	12	12	-5	270	410
KBK 12	32	6	32	4.5 x 8 x 4.4	12	12	-5	520	790
KBK 16	35	6	36	4.5 x 8 x 4.4	12	12	-7	590	910
KBK 20	42	8	43	5.5 x 9.5 x 5.4	15	15	-9	880	1400
KBK 25	50	8	51	5.5 x 9.5 x 5.4	15	15	-9	1000	1600
KBK 30	60	10	62	6.6 x 11 x 6.5	15	15	-9	1600	2800
KBK 40	75	13	80	9 x 14 x 8.6	20	20	-13	2200	4100
KBK 50	88	13	94	9 x 14 x 8.6	20	20	-13	3900	8100
KBK 60	106	18	112	11 x 17.5 x 10.8	25	25	-13	4800	10200

Sigla d'ordine/Specification number: KBK – d – PP [tenute in entrambi i lati / seals on both sides].
 Sigla d'ordine/Specification number: KBK – d [senza tenute / without seals].

Esempio: KBK 20 PP (modello KBK, diametro albero 20 mm, tenute in entrambi i lati).
 Example: KBK 20 PP (KBK model, shaft diameter 20 mm, seals on both sides).

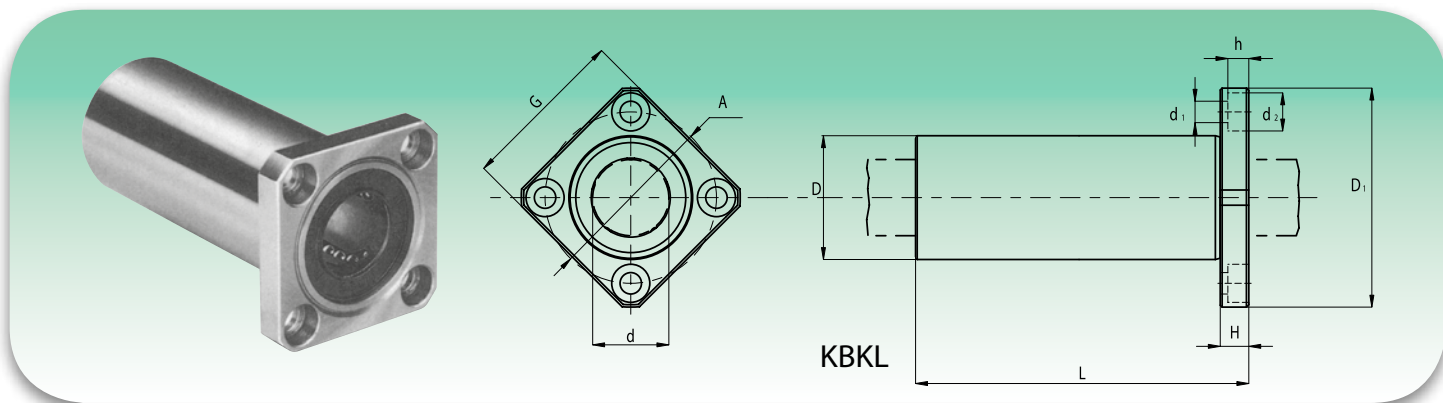

KBKL = Gabbia in poliammide - *Polyamide cage*

Tipologia Type	N° ricircoli Number of ball rows	Peso Weight [kg]	d [mm]	d Tolleranza Tolerance [μm]	D [mm]	D Tolleranza Tolerance [μm]	L [mm]	L Tolleranza Tolerance [mm]	D1 [mm]	D1 Tolleranza Tolerance [mm]
KBKL 08	4	0.046	8	+9 ÷ -1	16	0 ÷ -9	45	0 ÷ -0.3	32	0 ÷ -0.2
KBKL 12	4	0.082	12	+9 ÷ -1	22	0 ÷ -11	57	0 ÷ -0.3	42	0 ÷ -0.2
KBKL 16	5	0.160	16	+9 ÷ -11	26	0 ÷ -11	70	0 ÷ -0.3	46	0 ÷ -0.2
KBKL 20	5	0.230	20	+9 ÷ -11	32	0 ÷ -13	80	0 ÷ -0.3	54	0 ÷ -0.2
KBKL 25	6	0.475	25	+13 ÷ -2	40	0 ÷ -13	112	0 ÷ -0.4	62	0 ÷ -0.2
KBKL 30	6	0.575	30	+13 ÷ -2	47	0 ÷ -13	123	0 ÷ -0.4	76	0 ÷ -0.2
KBKL 40	6	1.380	40	+16 ÷ -4	62	0 ÷ -15	154	0 ÷ -0.4	98	0 ÷ -0.3
KBKL 50	6	3.300	50	+16 ÷ -4	75	0 ÷ -15	192	0 ÷ -0.4	112	0 ÷ -0.3
KBKL 60	6	4.060	60	+16 ÷ -4	90	0 ÷ -20	211	0 ÷ -0.4	134	0 ÷ -0.3

Tipologia Type	G [mm]	H [mm]	A [mm]	d1xd2xh [mm]	Tolleranza perpendicolarità flangia Perpendicularity flange tolerance [μm]	Eccentricità max Max eccentricity [μm]	Tolleranza gioco radiale Radial clearance tolerance [μm]	Capacità di Carico Load capacity rating [N]	
								C	C ₀
KBKL 08	25	5	24	3.4 x 6.5 x 3.3	12	12	-5	431	784
KBKL 12	32	6	32	4.5 x 8 x 4.4	12	12	-5	657	1200
KBKL 16	35	6	36	4.5 x 8 x 4.4	12	12	-7	1230	2350
KBKL 20	42	8	43	5.5 x 9.5 x 5.4	15	15	-7	1400	2750
KBKL 25	50	8	51	5.5 x 9.5 x 5.4	15	15	-9	1560	3140
KBKL 30	60	10	62	6.6 x 11 x 6.5	15	15	-9	2490	5490
KBKL 40	75	13	80	9 x 14 x 8.6	20	20	-13	3430	8040
KBKL 50	88	13	94	9 x 14 x 8.6	20	20	-13	6080	15900
KBKL 60	106	18	112	11 x 17.5 x 10.8	25	25	-13	7650	20000

Sigla d'ordine/Specification number: KBKL – d – PP [tenute in entrambi i lati / seals on both sides].
 Sigla d'ordine/Specification number: KBKL – d [senza tenute / without seals].

Esempio: KBKL 20 PP (modello KBKL, diametro albero 20 mm, tenute in entrambi i lati).
 Example: KBKL 20 PP (KBKL model, shaft diameter 20 mm, seals on both sides).

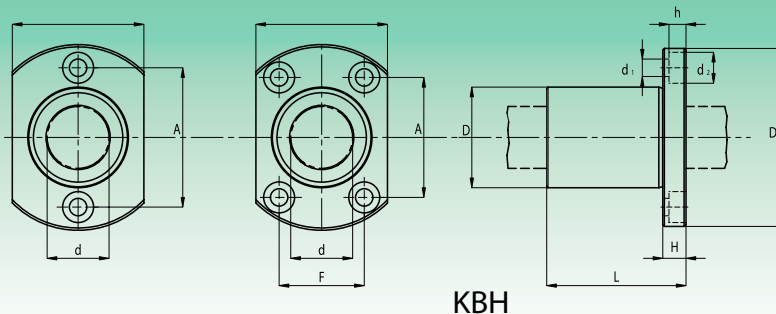
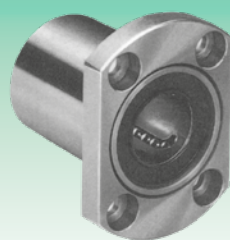
Manicotti a sfere serie pesante flangia tonda tagliata (KBH)
Slide bushes, heavy series round cutted flange (KBH)

KBH

KBH = Gabbia in poliammide - Polyamide cage

Tipologia Type	N° ricircoli Number of ball rows	Peso Weight [kg]	d [mm]	d Tolleranza Tolerance [μm]	D [mm]	D Tolleranza Tolerance [μm]	L [mm]	L Tolleranza Tolerance [mm]	D1 [mm]	D1 Tolleranza Tolerance [mm]
KBH 06	4	0.021	6	0 ÷ -9	12	0 ÷ -11	19	0 ÷ -0.2	28	0 ÷ -0.2
KBH 08	4	0.033	8	0 ÷ -9	15	0 ÷ -11	24	0 ÷ -0.2	32	0 ÷ -0.2
KBH 10	4	0.064	10	0 ÷ -9	19	0 ÷ -13	29	0 ÷ -0.2	40	0 ÷ -0.2
KBH 12	4	0.068	12	0 ÷ -9	21	0 ÷ -13	30	0 ÷ -0.2	42	0 ÷ -0.2
KBH 13	4	0.081	13	0 ÷ -9	23	0 ÷ -13	32	0 ÷ -0.2	43	0 ÷ -0.2
KBH 16	5	0.112	16	0 ÷ -9	28	0 ÷ -13	37	0 ÷ -0.2	48	0 ÷ -0.2
KBH 20	5	0.167	20	0 ÷ -10	32	0 ÷ -16	42	0 ÷ -0.2	54	0 ÷ -0.2
KBH 25	6	0.325	25	0 ÷ -10	40	0 ÷ -16	59	0 ÷ -0.3	62	0 ÷ -0.2
KBH 30	6	0.388	30	0 ÷ -10	45	0 ÷ -16	64	0 ÷ -0.3	74	0 ÷ -0.2

Tipologia Type	W [mm]	H [mm]	A [mm]	F [mm]	d1xd2xh [mm]	Tolleranza perpendicolarità flangia Perpendicularity flange tolerance [μm]	Eccentricità max Max eccentricity [μm]	Tolleranza gioco radiale Radial clearance tolerance [μm]	Capacità di Carico Load capacity rating [N]	
									C	C ₀
KBH 06	18	5	20	-	3.4 x 6.5 x 3.3	12	12	-5	210	270
KBH 08	21	5	24	-	3.4 x 6.5 x 3.3	12	12	-5	270	410
KBH 10	25	6	29	-	4.5 x 8 x 4.4	12	12	-5	380	560
KBH 12	27	6	32	-	4.5 x 8 x 4.4	12	12	-5	420	610
KBH 13	29	6	33	-	4.5 x 8 x 4.4	12	12	-7	520	790
KBH 16	34	6	31	22	4.5 x 8 x 4.4	12	12	-7	790	1200
KBH 20	38	8	36	24	5.5 x 9.5 x 5.4	15	15	-9	880	1400
KBH 25	46	8	40	32	5.5 x 9.5 x 5.4	15	15	-9	1000	1600
KBH 30	51	10	49	35	6.6 x 11 x 6.5	15	15	-9	1600	2800

Sigla d'ordine/Specification number: KBH – d – PP [tenute in entrambi i lati / seals on both sides].
 Sigla d'ordine/Specification number: KBH – d [senza tenute / without seals].

Esempio: KBH 20 PP (modello KBH, diametro albero 20 mm, tenute in entrambi i lati).
 Example: KBH 20 PP (KBH model, shaft diameter 20 mm, seals on both sides).

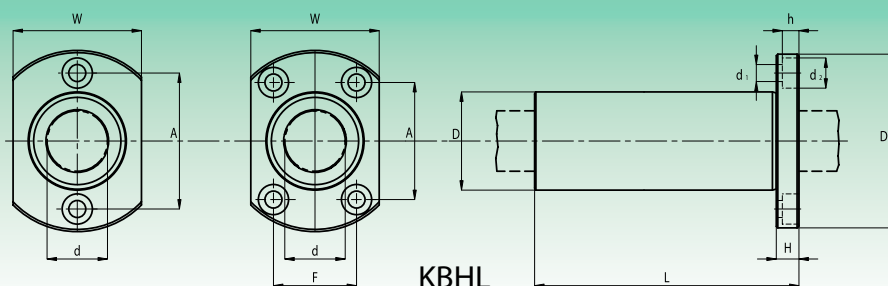
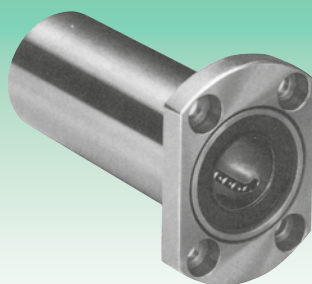

KBHL = Gabbia in poliammide - Polyamide cage

Tipologia Type	N° ricircoli Number of ball rows	Peso Weight [kg]	d [mm]	d Tolleranza Tolerance [μm]	D [mm]	D Tolleranza Tolerance [μm]	L [mm]	L Tolleranza Tolerance [mm]	D1 [mm]	D1 Tolleranza Tolerance [mm]
KBHL 06	4	0.027	6	0 ÷ -10	12	0 ÷ -13	35	0 ÷ -0.3	28	0 ÷ -0.2
KBHL 08	4	0.046	8	0 ÷ -10	15	0 ÷ -13	45	0 ÷ -0.3	32	0 ÷ -0.2
KBHL 10	4	0.091	10	0 ÷ -10	19	0 ÷ -16	55	0 ÷ -0.3	40	0 ÷ -0.2
KBHL 12	4	0.092	12	0 ÷ -10	21	0 ÷ -16	57	0 ÷ -0.3	42	0 ÷ -0.2
KBHL 13	4	0.117	13	0 ÷ -10	23	0 ÷ -16	61	0 ÷ -0.3	43	0 ÷ -0.2
KBHL 16	5	0.165	16	0 ÷ -10	28	0 ÷ -16	70	0 ÷ -0.3	48	0 ÷ -0.2
KBHL 20	5	0.247	20	0 ÷ -12	32	0 ÷ -19	80	0 ÷ -0.3	54	0 ÷ -0.2
KBHL 25	6	0.500	25	0 ÷ -12	40	0 ÷ -19	112	0 ÷ -0.4	62	0 ÷ -0.2
KBHL 30	6	0.580	30	0 ÷ -12	45	0 ÷ -19	123	0 ÷ -0.4	74	0 ÷ -0.2

Tipologia Type	W [mm]	H [mm]	A [mm]	F [mm]	d1xd2xh [mm]	Tolleranza perpendicolarità flangia Perpendicularity flange tolerance [μm]	Eccentricità max Max eccentricity [μm]	Tolleranza gioco radiale Radial clearance tolerance [μm]	Capacità di Carico Load capacity rating [N]	
									C	C ₀
KBHL 06	18	5	20	-	3.4 x 6.5 x 3.3	15	15	-5	330	540
KBHL 08	21	5	24	-	3.4 x 6.5 x 3.3	15	15	-5	440	800
KBHL 10	25	6	29	-	4.5 x 8 x 4.4	15	15	-5	600	1120
KBHL 12	27	6	32	-	4.5 x 8 x 4.4	15	15	-5	670	1220
KBHL 13	29	6	33	-	4.5 x 8 x 4.4	15	15	-7	830	1600
KBHL 16	34	6	31	22	4.5 x 8 x 4.4	15	15	-7	1250	2400
KBHL 20	38	8	36	24	5.5 x 9.5 x 5.4	20	20	-9	1430	2800
KBHL 25	46	8	40	32	5.5 x 9.5 x 5.4	20	20	-9	1590	3200
KBHL 30	51	10	49	35	6.6 x 11 x 6.5	20	20	-9	2540	5600

Sigla d'ordine/Specification number: KBHL - d - PP [tenute in entrambi i lati / seals on both sides].

Sigla d'ordine/Specification number: KBHL - d [senza tenute / without seals].

Esempio: KBHL 20 PP (modello KBHL, diametro albero 20 mm, tenute in entrambi i lati).

Example: KBHL 20 PP (KBHL model, shaft diameter 20 mm, seals on both sides).

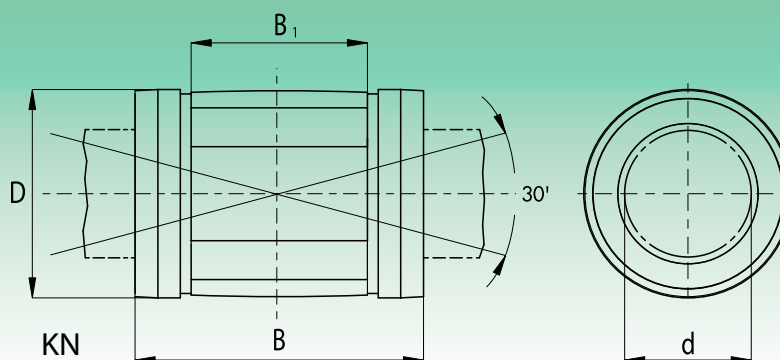
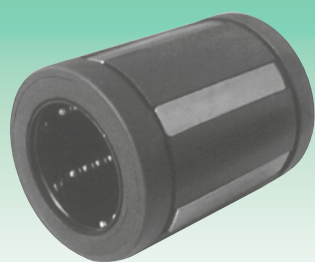
Manicotti a sfere autoallineanti (KN)
Self-aligning slide bushes (KN)

Tipologia Type	N° ricircoli Number of ball rows	Peso Weight [kg]	Dimensioni Dimensions				Gioco radiale Radial clearance			Capacità di Carico Load capacity rating [N]	
			d [mm]	D [mm]	B [mm]	B ₁ [mm]	h7/H7 [μm]	h7/JS7 [μm]	h6/JS6 [μm]	C	C ₀
KN 12 32	5	0.023	12	22	32	20	+32 +3	+28 -1	+22 0	650	520
KN 16 36	5	0.028	16	26	36	22	+32 +3	+28 -1	+22 0	800	630
KN 20 45	6	0.061	20	32	45	28	+37 +4	+30 -2	+24 0	1500	1250
KN 25 58	6	0.122	25	40	58	40	+37 +5	+31 -2	+24 0	2500	2200
KN 30 68	6	0.185	30	47	68	48	+39 +3	+33 -3	+27 0	3200	2800
KN 40 80	6	0.360	40	62	80	56	+42 +1	+34 -6	+27 -4	5500	4900
KN 50 100	6	0.580	50	75	100	72	+31 0	+26 -7	+26 -4	8600	7100

Sigla d'ordine/Specification number: KN – d – PP [tenute in entrambi i lati / seals on both sides].
 Sigla d'ordine/Specification number: KN – d [senza tenute / without seals].

Esempio: KN 20 PP (modello KN, diametro albero 20 mm, tenute in entrambi i lati).
 Example: KN 20 PP (KN model, shaft diameter 20 mm, seals on both sides).

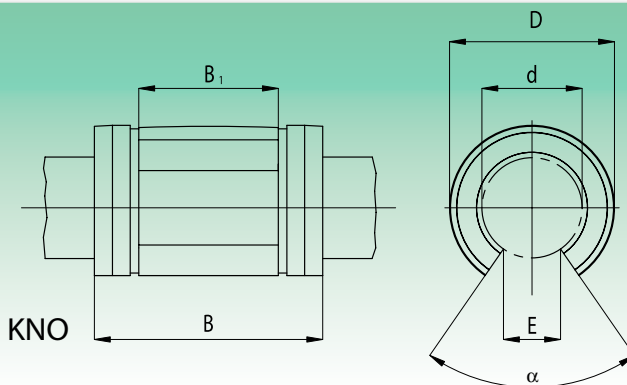
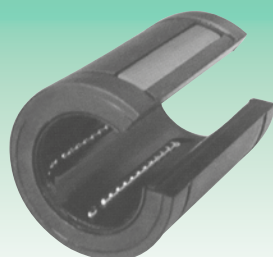

Tipologia Type	N° ricircoli Number of ball rows	Peso Weight [kg]	Dimensioni Dimensions						Gioco radiale Radial clearance			Capacità di Carico Load capacity rating [N]	
			d [mm]	D [mm]	B [mm]	B ₁ [mm]	E [mm]	α	h7/H7 [μm]	h7/JS7 [μm]	h6/JS6 [μm]	C	C ₀
KNO 12 32	4	0.018	12	22	32	20	6.5	66°	+32 +3	+28 -1	+22 0	750	600
KNO 16 36	4	0.022	16	26	36	22	9	68°	+32 +3	+28 -1	+22 0	920	730
KNO 20 45	5	0.051	20	32	45	28	9	55°	+37 +4	+30 -2	+24 0	1560	1240
KNO 25 58	5	0.102	25	40	58	40	11.5	57°	+37 +5	+31 -2	+24 0	2600	2260
KNO 30 68	5	0.155	30	47	68	48	14	57°	+39 +3	+33 -3	+27 0	3330	2850
KNO 40 80	5	0.300	40	62	80	56	19.5	56°	+42 +1	+34 -6	+27 -4	5720	4900
KNO 50 100	5	0.480	50	75	100	72	22.5	54°	+41 0	+26 -7	+26 -4	8940	7200

Sigla d'ordine/Specification number:

KNO – d – PP

[tenute in entrambi i lati / seals on both sides].

Sigla d'ordine/Specification number:

KNO – d

[senza tenute / without seals].

Esempio: KNO 20 PP (modello KNO, diametro albero 20 mm, tenute in entrambi i lati).

Example: KNO 20 PP (KNO model, shaft diameter 20 mm, seals on both sides).



Supporti di estremità per alberi (SK)

End shaft supports (SK)

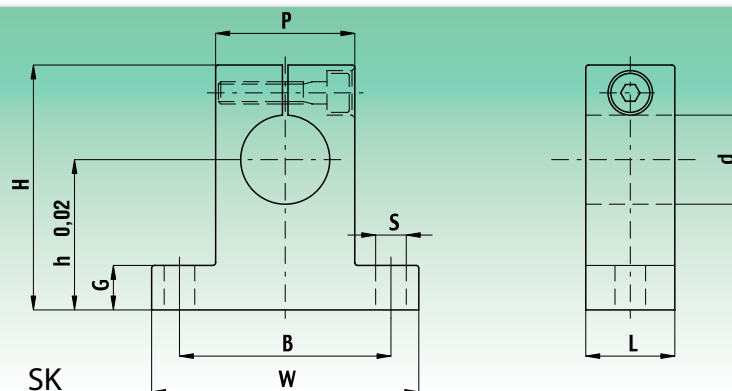
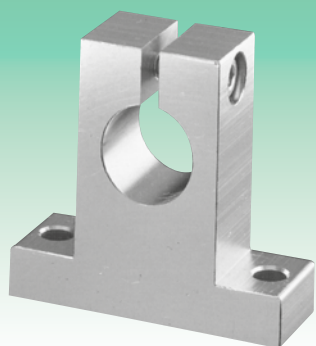

Tipologia Type	Peso Weight [kg]	d [mm]	h [mm]	W [mm]	B [mm]	P [mm]	S [mm]	G [mm]	H [mm]	L [mm]	Viti di montaggio Mounting bolt
SK 08	0.024	8	20	42	32	18	5.5	6	32.8	14	M 5
SK 10	0.024	10	20	42	32	18	5.5	6	32.8	14	M 5
SK 12	0.030	12	23	42	32	20	5.5	6	37.5	14	M 5
SK 13	0.030	13	23	42	32	20	5.5	6	37.5	14	M 5
SK 16	0.040	16	27	48	38	25	5.5	8	44	16	M 5
SK 20	0.070	20	31	60	45	30	6.6	10	51	20	M 6
SK 25	0.130	25	35	70	56	38	6.6	12	60	24	M 6
SK 30	0.180	30	42	84	64	44	9	12	70	28	M 8
SK 35	0.270	35	50	98	74	50	11	15	85	32	M 10
SK 40	0.420	40	60	114	90	60	11	15	96	36	M 10
SK 50	0.750	50	70	126	100	74	14	18	120	40	M 12
SK 60	1.100	60	80	148	120	90	14	18	136	45	M 12

Sigla d'ordine:

SK - d

Specification number:

SK - d



Supporti in lega di alluminio**Aluminium linear case units**

I supporti ISB si suddividono in:

Serie normale:

- standard (SC)
- corti (SCV)
- lunghi (SCW)

Serie aperta:

- non flangiati (SBR)
- flangiati (TBR)

Tutti possono essere forniti con:

- anelli di tenuta in entrambi i lati (suffisso - UU)
- senza anelli di tenuta (nessun suffisso).

ISB linear case units can be divided into:

Normal series:

- standard (SC)
- short (SCV)
- long (SCW)

Open series:

- not flanged (SBR)
- flanged (TBR)

They can be supplied with:

- seals on both sides (suffix – UU)
- without seals (no suffix).

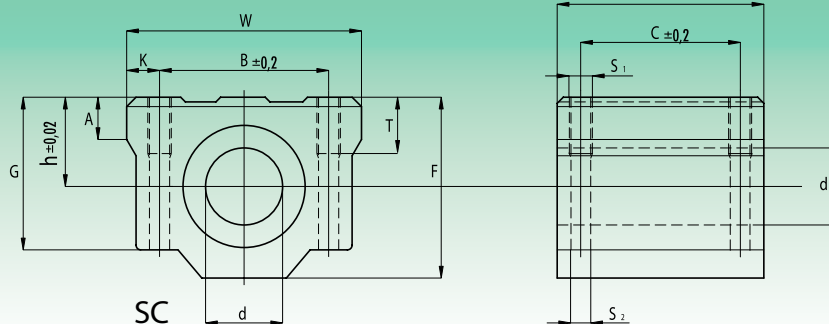
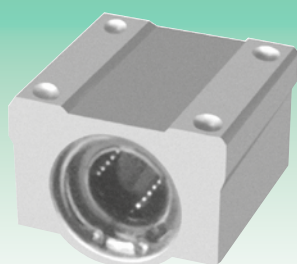
Supporti con manicotto pesante (SC)
Linear case units with heavy slide bush (SC)

Tipologia Type	Peso Weight [kg]	d [mm]	W [mm]	F [mm]	L [mm]	h [mm]	G [mm]	T [mm]	A [mm]	B [mm]	C [mm]	K [mm]	S ₁ [mm]	S ₂ [mm]	Capacità di Carico Load capacity rating [N]	
															C	C ₀
SC 08	0.056	8	34	22	30	11	18	6	5	24	18	5	M 4	3.4	280	400
SC 10	0.090	10	40	26	35	13	21	8	6	28	21	6	M 5	4.3	380	560
SC 12	0.112	12	44	30	36	15	25	12	8	33	26	5.75	M 5	4.3	420	610
SC 13	0.123	13	44	30	39	15	24.5	8	5.5	33	26	5.5	M 5	4.3	520	800
SC 16	0.189	16	50	38.5	44	19	32.5	9	7	36	34	7	M 5	4.3	790	1200
SC 20	0.237	20	54	42	50	21	35	11	7	40	40	7	M 6	5.2	900	1400
SC 25	0.555	25	76	51.5	67	26	42	12	11	54	50	11	M 8	6.8	1000	1600
SC 30	0.685	30	78	59.5	76	30	49	15	10	58	58	10	M 8	6.8	1600	2800
SC 35	1.100	35	90	68	80	34	54	18	10	70	60	10	M 8	6.8	1700	3200
SC 40	1.600	40	102	78	90	40	62	20	11	80	60	11	M 10	8.6	2200	4100
SC 50	3.350	50	122	102	110	52	80	25	11	100	80	11	M 10	8.6	3900	8100
SC 60	4.270	60	132	114	122	58	94	30	21	108	90	12	M 12	10.7	4800	10200

Sigla d'ordine/Specification number:

Sigla d'ordine/Specification number:

SC - d - UU [tenute in entrambi i lati / seals on both sides].

SC - d [senza tenute / without seals].

 SC - d - UU AS [tenute in entrambi i lati e foro di lubrificazione/
seals on both sides and oil hole].

 SC - d - AS [senza tenute, con foro di lubrificazione/
without seals, with oil hole].

Esempio: SC 20 UU AS (modello SC, diametro albero 20 mm, tenute in entrambi i lati, foro di lubrificazione).

Example: SC 20 UU AS (SC model, shaft diameter 20 mm, seals on both sides, with oil hole).

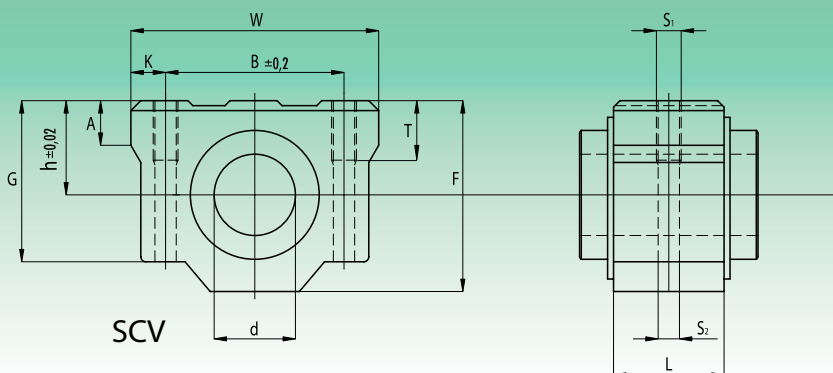
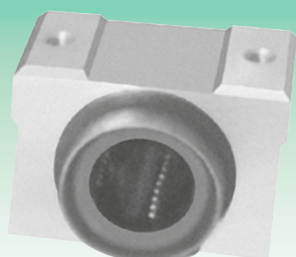

Tipologia Type	Peso Weight [kg]	d [mm]	W [mm]	F [mm]	L [mm]	h [mm]	G [mm]	T [mm]	B [mm]	A [mm]	K [mm]	S ₁ [mm]	S ₂ [mm]	Capacità di Carico Load capacity rating [N]	
														C	C ₀
SCV 08	0.063	8	34	22	15.4	11	18	6	24	5	5	M 4	3.4	280	400
SCV 10	0.092	10	40	26	19.5	13	21	8	28	6	6	M 5	4.3	380	560
SCV 12	0.102	12	42	30	20.5	15	25	12	33	8	5.75	M 5	4.3	420	610
SCV 13	0.120	13	44	30	20.5	15	24.5	8	33	5.5	5.5	M 5	4.3	520	800
SCV 16	0.200	16	50	38.5	23.5	19	32.5	9	36	7	7	M 5	4.3	790	1200
SCV 20	0.255	20	54	42	28.3	21	35	11	40	7	7	M 6	5.2	900	1400
SCV 25	0.600	25	76	51.5	40.4	26	42	12	54	11	11	M 8	6.8	1000	1600
SCV 30	0.735	30	78	59.5	40.9	30	49	15	58	10	10	M 8	6.8	1600	2800
SCV 35	1.100	35	90	68	45.4	34	54	18	70	10	10	M 8	6.8	1700	3200
SCV 40	1.590	40	102	78	56.4	40	62	20	80	11	11	M 10	8.6	2200	4100
SCV 50	3.340	50	122	102	68.9	52	80	25	100	11	11	M 10	8.6	3900	8100

Sigla d'ordine/Specification number:

Sigla d'ordine/Specification number:

SCV – d – UU [tenute in entrambi i lati / seals on both sides].

SCV – d [senza tenute / without seals].

 SCV – d – UU AS [tenute in entrambi i lati e foro di lubrificazione/
seals on both sides and oil hole].

 SCV – d – AS [senza tenute, con foro di lubrificazione/
without seals, with oil hole].

Esempio: SCV 20 UU AS (modello SCV, diametro albero 20 mm, tenute in entrambi i lati, foro di lubrificazione).

Example: SCV 20 UU AS (SCV model, shaft diameter 20 mm, seals on both sides, with oil hole).

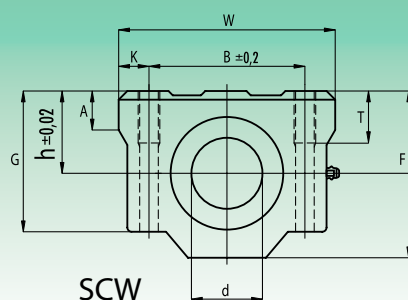
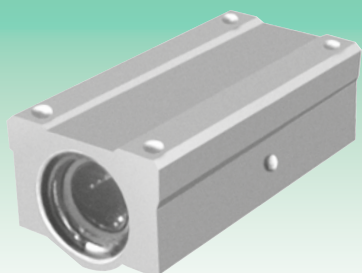
Supporti con manicotto pesante KB lunghi (SCW)
Linear case units with heavy slide bush KB, long type (SCW)

SCW

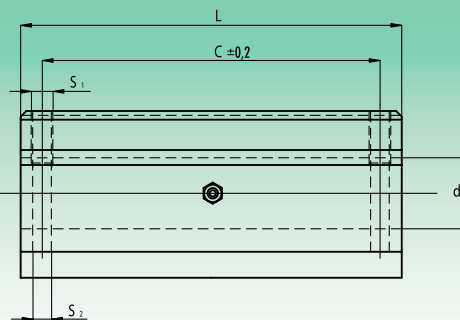

Tipologia Type	Peso Weight [kg]	d [mm]	W [mm]	F [mm]	L [mm]	h [mm]	G [mm]	A [mm]	T [mm]	B [mm]	C [mm]	K [mm]	S ₁ [mm]	S ₂ [mm]	Capacità di Carico Load capacity rating [N]	
															C	C ₀
SCW 08	0.102	8	34	22	58	11	18	6	8	24	42	5	M 4	3.4	440	800
SCW 10	0.106	10	40	26	68	13	21	8	10	28	46	6	M 5	4.3	600	1120
SCW 12	0.205	12	44	30	77	15	26	8	10	33	64	5.5	M 5	4.3	670	1200
SCW 16	0.400	16	50	38.5	89	19	35	9	12	36	79	7	M 5	4.3	1250	2400
SCW 20	0.570	20	54	42	106	21	36	11	12	40	90	7	M 6	5.2	1440	2800
SCW 25	1.200	25	76	51.5	136	26	41	12	18	54	119	11	M 8	6.8	1640	3200
SCW 30	1.480	30	78	59.5	154	30	49	15	18	58	132	10	M 8	6.8	2500	5600
SCW 35	2.200	35	90	68	155	34	54	18	18	70	120	10	M 8	6.8	2700	6400
SCW 40	3.200	40	102	78	180	40	62	20	25	80	150	11	M 10	8.6	3500	8200
SCW 50	6.700	50	122	102	230	52	80	25	25	100	200	11	M 10	8.6	6200	16200
SCW 60	8.560	60	132	114	240	58	94	30	25	108	180	12	M 12	10.7	7700	20400

Sigla d'ordine/Specification number:
Sigla d'ordine/Specification number:

SCW – d – UU [tenute in entrambi i lati / seals on both sides].
 SCW – d [senza tenute / without seals].
 SCW – d – UU AS [tenute in entrambi i lati e foro di lubrificazione/
 seals on both sides and oil hole].
 SCW – d – AS [senza tenute, con foro di lubrificazione/
 without seals, with oil hole].

Esempio: SCW 20 UU AS (modello SCW, diametro albero 20 mm, tenute in entrambi i lati, foro di lubrificazione).

Example: SCW 20 UU AS (SCW model, shaft diameter 20 mm, seals on both sides, with oil hole).

Note: Il supporto SCW viene fornito standard AS (con foro di lubrificazione).

Note: SCW support is supplied standard AS (with oil hole).

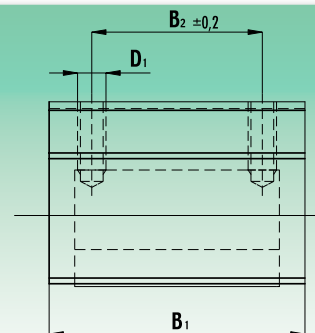
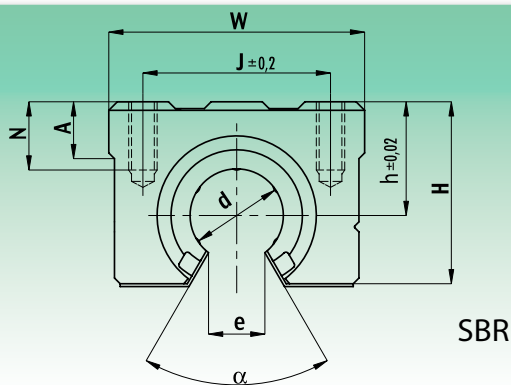
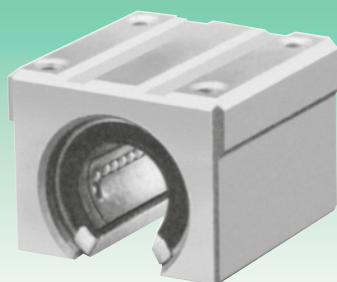

Tipologia Type	Peso Weight [kg]	d [mm]	A [mm]	B ₁ [mm]	B ₂ [mm]	D ₁ [mm]	e [mm]	α	h [mm]	H [mm]	J [mm]	N [mm]	W [mm]	Capacità di Carico Load capacity rating [N]	
														C	C ₀
SBR 16	0.150	16	9	45	30	M 5	10	80°	20	33	32	12	45	590	910
SBR 20	0.200	20	11	50	35	M 6	10	60°	23	39	35	12	48	880	1400
SBR 25	0.450	25	14	65	40	M 6	11.5	50°	27	47	40	12	60	1000	1600
SBR 30	0.630	30	15	70	50	M 8	14	50°	33	56	50	18	70	1600	2800
SBR 40	1.330	40	20	90	65	M 10	19	50°	42	72	65	20	90	2200	4100
SBR 50	3.000	50	25	110	80	M 10	23	50°	53	91	94	20	120	3900	8100

Sigla d'ordine/Specification number:

SBR – d – UU [tenute in entrambi i lati / seals on both sides].

Sigla d'ordine/Specification number:

 SBR – d – UU AS [tenute in entrambi i lati e foro di lubrificazione/
seals on both sides and oil hole].

Esempio: SBR 20 UU AS (modello SBR, diametro albero 20 mm, tenute in entrambi i lati, foro di lubrificazione).

Example: SBR 20 UU AS (SBR model, shaft diameter 20 mm, seals on both sides, with oil hole).



Supporti aperti tipo flangiato con manicotto pesante KBO (TBR)

Open linear case units flanged type with heavy slide bush KBO (TBR)

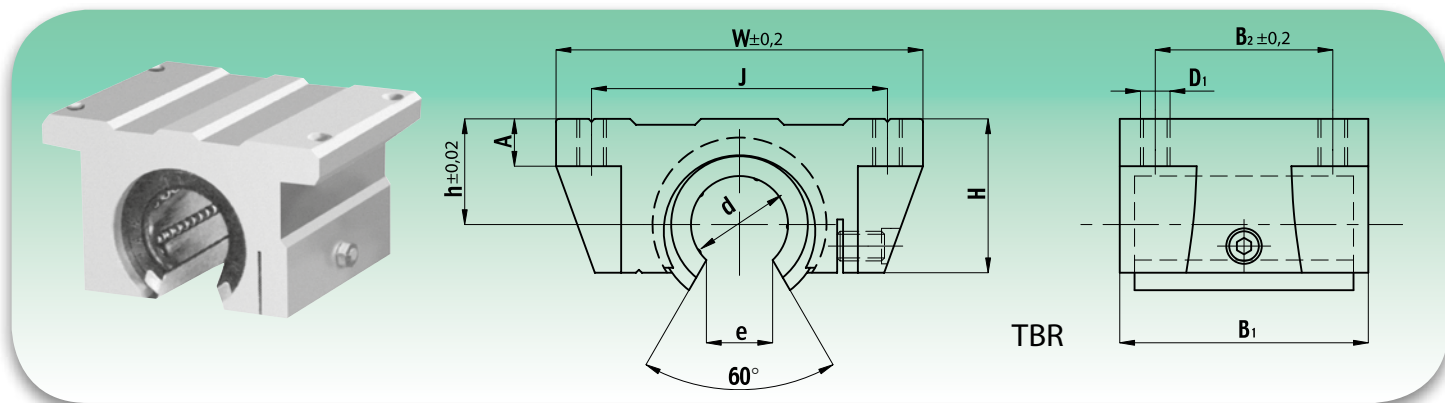

Tipologia Type	Peso Weight [kg]	d [mm]	A [mm]	B ₁ [mm]	B ₂ [mm]	D ₁ [mm]	e [mm]	h [mm]	H [mm]	J [mm]	W [mm]	Capacità di Carico Load capacity rating [N]	
												C	C ₀
TBR 16	0.180	16	8	42	30	M 5	10	17.9	27	50	62	392	490
TBR 20	0.300	20	10	51	37	M 6	10	21	31.4	54	68	784	1176
TBR 25	0.600	25	12	65	50	M 8	11.5	28	41	65	82	1568	2352
TBR 30	0.900	30	12	75	60	M 8	14	33.5	48	75	91	1764	2940

Sigla d'ordine/Specification number:

TBR – d – UU [tenute in entrambi i lati / seals on both sides].

Sigla d'ordine/Specification number:

TBR – d – UU AS [tenute in entrambi i lati e foro di lubrificazione / seals on both sides and oil hole].

Esempio: TBR 20 UU AS (modello TBR, diametro albero 20 mm, tenute in entrambi i lati, foro di lubrificazione).

Example: TBR 20 UU AS (TBR model, shaft diameter 20 mm, seals on both sides, with oil hole).





ООО "Технодрайв" тел.: 8(863) 223-20-99

email: info@technodrive.net

<http://technodrive.pro>



ООО "Технодрайв" тел.: 8(863) 223-20-99

email: info@technodrive.net

<http://technodrive.pro>



©Copyright 

È vietata la riproduzione anche parziale del contenuto di questo catalogo tecnico. Non si possono accettare responsabilità per eventuali errori od omissioni. Le misure, i disegni e le immagini non sono impegnativi. Marchio registrato Italia-EU.

The reproduction, even partial, of the contained concerning this technical catalogue, is forbidden. Liability for possible errors and/or omissions are not accepted. The measurements, drawings and images are not demanding. TM Registered in Italy-EU.





CUSCINETTI A RULLINI
NEEDLE BEARINGS

01.01.2018 ©Copyright ISB



679991002F51A18121700

